

Earthquake Safety at Home

FEMA P-530 / March 2020



FEMA



This page intentionally left blank.

Earthquake Safety at Home

Prepared by

APPLIED TECHNOLOGY COUNCIL
201 Redwood Shores Parkway, Suite 240
Redwood City, California 94065
www.ATCouncil.org

Prepared for

FEDERAL EMERGENCY MANAGEMENT AGENCY
Michael Mahoney, Project Officer
Andrew Herseth, Project Manager
Washington, D.C.

ATC MANAGEMENT AND OVERSIGHT

Jon A. Heintz, Program Executive, Program Manager
Ayse Hortacsu, Project Manager
Veronica Cedillos, Project Manager
Zahraa Saiyed, Project Management Consultant

Project Technical Committee

Colin Blaney (Project Technical Director)
Buehler Structural Engineers, Inc.

Michael Griffin
CCS Group, Inc.

Kelly E. Cobeen
Wiss Janney Elstner Associates, Inc.

Lucy Jones
Dr. Lucy Jones Center for Science and Society

Project Review Panel

Mark Benthien
Southern California Earthquake Center

Fred Turner
Alfred E. Alquist Seismic Safety Commission

Graphics Consultants

Christopher Mills
Christopher Mills Illustration

Christina Zagara
Creative Engagement Solutions, LLC

Carol Singer
Carol Singer Design



FEMA



ACKNOWLEDGEMENTS

FEMA 530 was originally developed and published by the California Seismic Safety Commission. This document also benefited greatly from the USGS publication, [Putting Down Roots in Earthquake Country](#), originally written by Lucy Jones and Mark Benthien.

NOTICE

Any opinions, findings, conclusions, or recommendations expressed in this publication do not necessarily reflect the views of the Applied Technology Council (ATC), the Department of Homeland Security (DHS), or the Federal Emergency Management Agency (FEMA). Additionally, neither ATC, DHS, FEMA, nor any of their employees, makes any warranty, expressed or implied, nor assumes any legal liability or responsibility for the accuracy, completeness, or usefulness of any information, product, or process included in this publication. Users of information from this publication assume all liability arising from such use.

Cover images – Illustration for drop, cover, and hold on during an earthquake event. Photos: (top) damaged chimney on a house in 2011 Mineral, Virginia Earthquake (photo by Jim Beavers, courtesy of the Earthquake Engineering Research Institute); (bottom) damaged house in 2014 Napa, California Earthquake (courtesy of Ronald Gallagher).

All online resources were accessed December 2019.

FEMA MISSION

Helping people before, during, and after disasters.

FEMA VISION

A prepared and resilient Nation.

“The most successful way to achieve disaster resiliency is through preparedness, including mitigation. Building a Culture of Preparedness within our communities and our governments will support a National effort to be ready for the worst disasters – at the individual, family, community, state, local, tribal, territorial, and Federal levels.”

- FEMA 2018-2022 Strategic Plan

Although the Nation must do more to assess and quantify increasing risks due to earthquakes, we do know that pre-disaster mitigation works. In 2018, an [independent study by the National Institute of Building Sciences](#), co-funded by FEMA, found that for every \$1 that the Federal Government invests in earthquake mitigation saves taxpayers an average of \$3 in future spending.

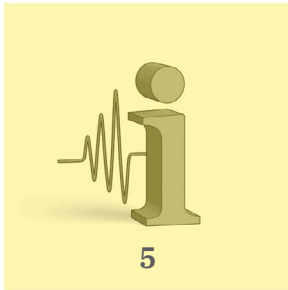
Furthermore, experience has shown repeatedly that individuals, communities, and businesses that manage risk through insurance recover faster and more fully after a disaster. If an individual does not have the value of their home and belongings in their savings, insurance will help them fill that gap when a disaster strikes. While FEMA disaster assistance supports survivors in the immediate aftermath of a presidentially-declared disaster, this federal support only serves as a temporary safety net for immediate needs and does not provide for complete financial recovery. Financial preparedness, including having an insurance policy on personal and public properties, is critical to helping rebuild a home, replace belongings, and restore order to a family and community.

How to Use this Guide

When you think of earthquakes, you might think, “I’m sure glad I don’t live in California!” The hard truth is that dangerous earthquakes can occur in many other parts of the country as well, but where else, why, and how often? Half of all Americans live in areas subject to earthquake risk and most Americans will travel to seismically active regions in their lifetime.

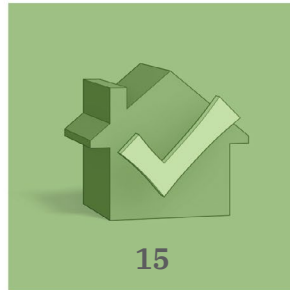
This guide will show you why you should care about earthquakes wherever you live, and how you can *Prepare, Protect, Survive, Respond, Recover and Repair*. It will help you become familiar with why and where earthquakes might occur and discuss steps you can take to adequately prepare and protect yourself, your family, and your belongings. These steps are wide ranging and include actions to prepare for an earthquake, such as developing family response plans, assembling earthquake disaster supplies, securing heavy objects and furniture, retrofitting your home, and more. During and immediately after an earthquake, guidelines for survival will help keep your family safe. Following an earthquake, recommendations for recovery and repair will help your family resume regular activities as quickly as possible.

The guide has been organized beginning with a brief introduction of earthquake risks throughout America followed by actionable advice for earthquake safety. The *Respond* section includes a post-earthquake *Home Safety Checklist*. Readers using the electronic version of this document can hover over and click online resource references to be taken to the source website. A list of resources are provided at the end of this document. You are encouraged to read the entire document in the order presented, or you can skip to a topic of particular interest.



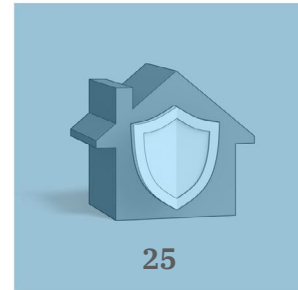
Earthquakes Across America

Understanding
Earthquake Basics
and Your Risk



Prepare

Securing Your Space,
Making a Plan,
and Organizing Your
Disaster Supplies



Protect

Identifying
and Addressing
Your Vulnerabilities



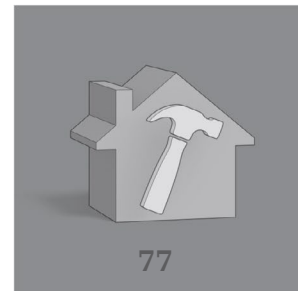
Survive

Knowing What to Do
During and Immediately
after the Earth Shakes



Respond

Getting Back in
Your Home -
The First Few Days



Recover and Repair

Restarting Utilities
and Repairing Damage

Supplement: Earthquakes Across America 86

Resources 102

Earthquakes Across America



Overview

This primer on earthquakes will show you why you should care about earthquakes, wherever you live. Half of all Americans are at risk from earthquake shaking, and all of us can suffer if a regional economy is severely damaged. We will learn that what you experience during an earthquake is not determined by the magnitude, but by how strong shaking is where you are and how that shaking impacts the built environment. We will learn how earthquakes are detected, and how you can help when you feel earthquakes. We will also learn about additional dangers that may come with shaking ground.

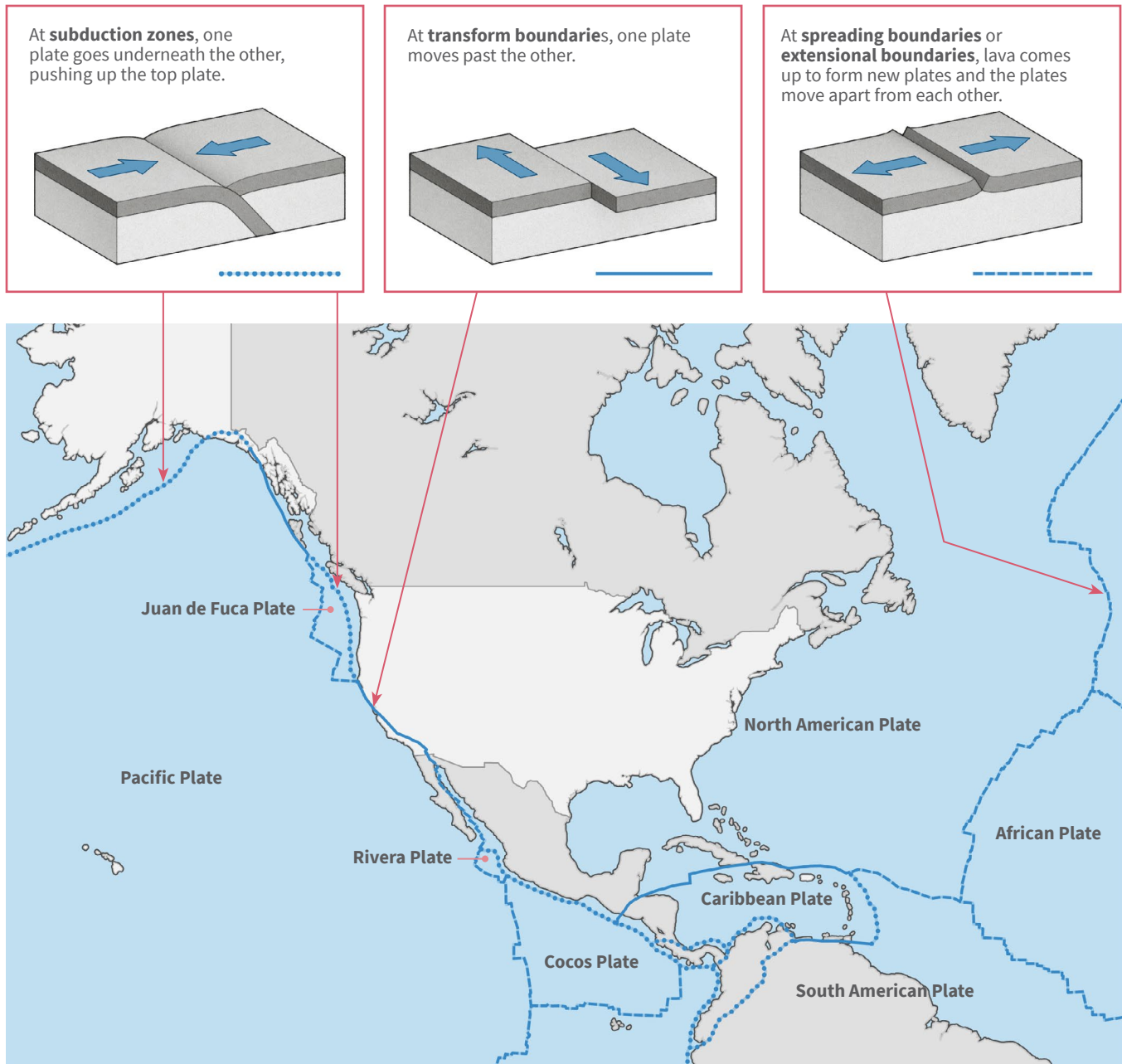
Do you know the earthquake risk in your location? By clicking on the map on [page 7](#), you can navigate to the *Supplement* section at the end of the guide that will show you where and why earthquakes have happened in the past.

What Causes Earthquakes?

Earthquakes result from movement of blocks of the Earth's crust. When a block of the crust is pushed past another along a fault, friction between the blocks keeps them from moving. Eventually, the force of the pushing will overcome the friction, and the blocks will move past each other releasing energy in waves that we feel as the earthquake.

The driving force behind the motion is plate tectonics. The theory of plate tectonics came together in the 1960s when geologists noticed the similarity of geologic formations separated by the Atlantic Ocean and seismologists observed the concentration of earthquakes in relatively narrow bands in only certain locations. Refer to the *Supplement* section at the end of the guide to learn more about plate tectonics in different regions of the country.

TYPES OF PLATE BOUNDARIES

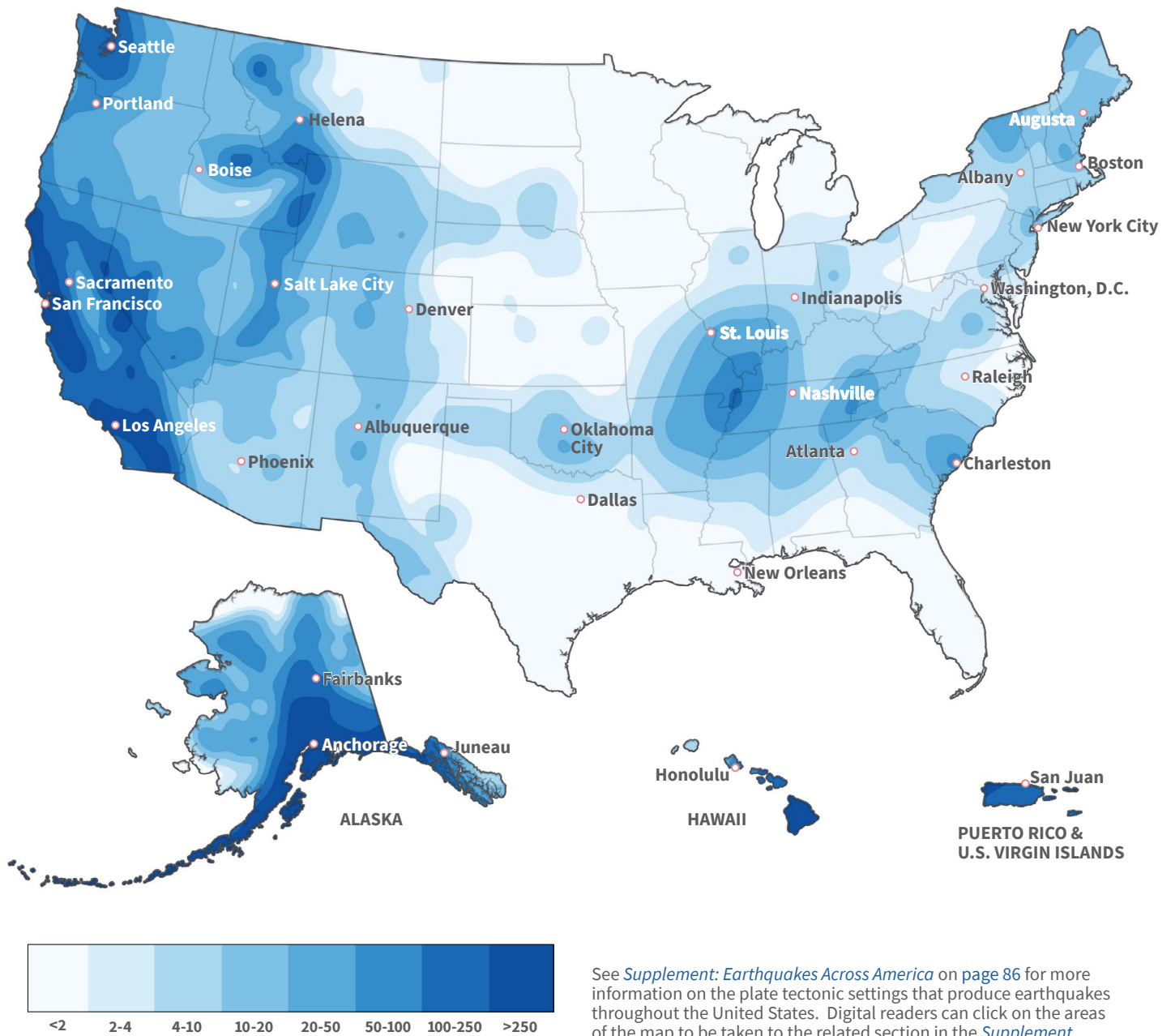


The blocks of the Earth that move together are called plates and the biggest faults are at the boundaries between plates. Most of the United States is on the North American Plate. Hot rock comes up from the mantle at mid-ocean ridges and cools, creating new sea floor that moves out over the softer mantle underneath. So the North American Plate grows from new ocean floor

in the middle of the Atlantic Ocean and pushes down other plates of cooled rock along subduction zones that run from northern California to Japan. In California, the North American Plate slides past the Pacific Plate. Because of this, the West Coast has more faults and more earthquakes than elsewhere in the United States, but earthquakes also happen within the plate.

MAP OF FREQUENCY OF DAMAGING EARTHQUAKE SHAKING IN THE UNITED STATES

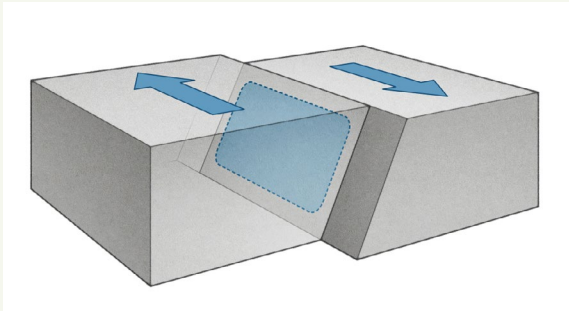
Source information courtesy of the United States Geological Survey (USGS)



See *Supplement: Earthquakes Across America* on page 86 for more information on the plate tectonic settings that produce earthquakes throughout the United States. Digital readers can click on the areas of the map to be taken to the related section in the *Supplement*.

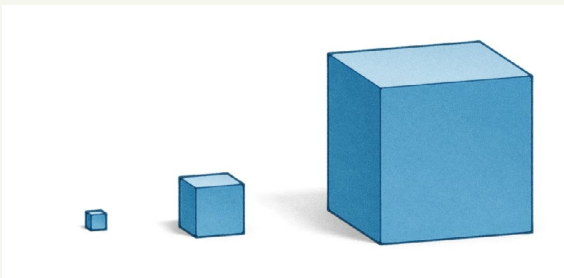
What is an Earthquake?

An earthquake is caused by a sudden slip on a fault, much like what happens when you snap your fingers. Before the snap, you push your fingers together and sideways. Because you are pushing them together, friction keeps them from moving to the side. When you push sideways hard enough to overcome this friction, your fingers move suddenly, releasing energy in the form of sound waves that set the air vibrating and travel from your hand to your ear, where you hear the snap. The same process happens in an earthquake. Stresses in the Earth's outer layer push the sides of the fault together. The friction across the surface of the fault holds the rocks together so they do not slip immediately when pushed sideways. Eventually, enough stress builds up and the rocks slip suddenly, releasing energy in waves that travel through the rock to cause the shaking that we feel during an earthquake. Just as you snap your fingers with the whole area of your fingertip and thumb, earthquakes happen over an area of the fault, called the rupture surface that is shown as the blue shaded area between the faults in the illustration.



Earthquake Magnitude

The volume of the cubes represents the energy released in the earthquakes. If the volume of the smallest cube is the energy in a magnitude-5 earthquake, then the volume of the largest cube is the energy in a magnitude 7. Each unit of magnitude is 32 times increase in energy released.



Measuring Earthquakes

MAGNITUDE

Magnitude is a number that describes the total energy released in an earthquake as measured by seismologists. The amount of energy released increases exponentially as the magnitude increases. For example, a magnitude-7 earthquake releases 1,000 times the energy of a magnitude-5 earthquake. Magnitude is measured by seismologists, and the most important factor in determining the magnitude of an earthquake is the area of the rupture surface. The fault for a magnitude-5 earthquake is a mile or less long, while the fault for a magnitude-7 earthquake will be 20 to 30 miles long.

SHAKING INTENSITY

The earthquake shaking felt and reported is described through something called *intensity*. This is the earliest measurement of earthquake size, and began as a description of the level of damage. Most countries, including the United States, use the Modified Mercalli Intensity scale (MMI). The descriptions for each intensity level are shown in the table on [page 9](#).

Intensity will depend on the location it is reported from and will generally be lower farther away from the fault. The *maximum intensity* is the intensity reported right on top of the fault and generally scales with magnitude. The table also shows the magnitude of earthquake for which a given intensity level would be felt at a location right above the earthquake's fault. For example, if you feel Intensity V shaking, you know that earthquake has to have a magnitude of at least 4. If the fault is far away, the magnitude would be much larger than 4 and the associated ground movement will be less because of the distance the waves had to travel. Note that the categories in the table are based on observations and not on measurements made by instruments.

Shaking Intensity versus Measured Magnitude

Modified Mercalli Intensity (MMI)	Description of Shaking and Damage	The magnitude of an earthquake likely to produce this intensity as its maximum shaking
I	Not felt except by a very few under especially favorable conditions.	2
II	Felt only by a few persons at rest, especially on upper floors of buildings.	3
III	Felt quite noticeably by persons indoors, especially on upper floors of buildings. Many people do not recognize it as an earthquake. Standing motor cars may rock slightly. Vibrations similar to the passing of a truck. Duration estimated.	3-4
IV	Felt indoors by many, outdoors by few during the day. At night, some awakened. Dishes, windows, doors disturbed; walls make cracking sound. Sensation like heavy truck striking building. Standing motor cars rocked noticeably.	4-4.5
V	Felt by nearly everyone; many awakened. Some dishes, windows broken. Unstable objects overturned. Pendulum clocks may stop.	4-5
VI	Felt by all, many frightened. Some heavy furniture moved; a few instances of fallen plaster. Damage slight.	5
VII	Damage negligible in buildings of good design and construction; slight to moderate in well-built ordinary structures; considerable damage in poorly built or badly designed structures; some chimneys broken.	5.5-6
VIII	Damage slight in specially designed structures; considerable damage in ordinary substantial buildings with partial collapse. Damage great in poorly built structures. Fall of chimneys, factory stacks, columns, monuments, walls. Heavy furniture overturned.	6-6.5
IX	Damage considerable in specially designed structures; well-designed frame structures thrown out of plumb. Damage great in substantial buildings, with partial collapse. Buildings shifted off foundations.	6.5-7
X	Some well-built wooden structures destroyed; most masonry and frame structures destroyed with foundations. Rails bent.	7 and higher

Source information courtesy of the United States Geological Survey (USGS).

Detecting Earthquakes

When an earthquake happens, it is recorded by the United States Geological Survey (USGS). In the earthquake, the slip of a block of rock past another releases energy that makes the ground vibrate. That vibration pushes the adjoining piece of ground, causing it to vibrate, and thus the energy travels out from the earthquake in a wave. As the wave passes by a seismic station, that piece of ground vibrates and the vibration is recorded. Each seismic station in the network measures the movement of the ground at that site.

Earthquakes produce two main types of waves—the P-wave (a compressional wave), and the S-wave (a shear wave). The S-wave is both slower and larger than the P-wave, and it does most of the damage. Knowing how fast seismic waves travel through the earth, seismologists can calculate the time the earthquake occurred and its location by comparing the times the shaking was

recorded at several stations. This process of calculating the earthquake magnitude used to take almost an hour. Now, with the help of computers, this information is automatically generated within minutes or even seconds. Within a few hours, the shape and location of the entire portion of the fault that moved can be calculated.

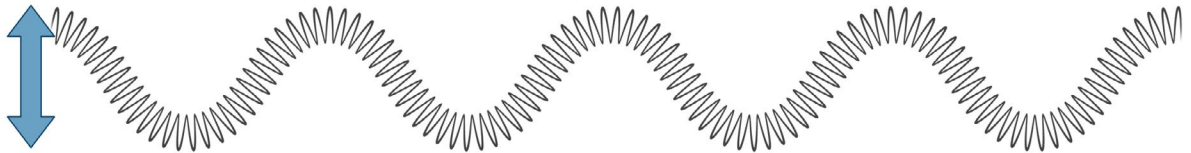
Even if you are not a trained seismologist with access to equipment, you can help detect earthquakes by sharing information with the USGS on their Community Internet Intensity reporting program, referred to as “[Did You Feel It?](#)” (DYFI). DYFI collects information from individuals who felt an earthquake and creates maps that show extent of damage and shaking intensity. This information from the public informs scientists on ground motion behavior and helps validate past research and theory relating to earthquakes.

P-WAVE



In a P-wave, the ground particles are moving with the wave.

S-WAVE



In an S-wave, the ground particles are pushed sideways relative to the wave.

Earthquake Shaking

There are a lot of factors that control how much shaking is felt. These include:

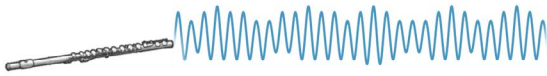
Magnitude. A larger magnitude earthquake means that the energy is coming off of a bigger fault, releasing the energy over a larger area and for a longer period of time. You would feel more intense shaking, and more damage is expected.

Distance. Earthquake waves die off as they travel through the ground, so earthquake shaking is less intense farther from the fault. Low-frequency waves diminish less rapidly with distance than high-frequency

waves. Sound waves behave similarly, as seen in the figure below. If you are near an earthquake, you will experience all the shaking produced by the earthquake and feel “jolted.” Farther away, the higher frequencies will have died away and you will feel a rolling motion. The amount of damage to a building does not depend solely on how hard it is shaken. In general, smaller buildings, such as houses, are damaged more by higher frequencies, so houses must be relatively close to the fault to be severely damaged. Larger structures, such as high-rises and bridges, are damaged more by lower frequencies and will be more noticeably affected by larger earthquakes, even at considerable distances.

WAVE FREQUENCIES

High Frequency



Low Frequency

Sound wave frequencies are similar to earthquake waves. Low frequency waves travel farther than the high-frequency waves.

Soil conditions. Soils can greatly amplify the shaking in an earthquake. Passing from rock to soil, seismic waves slow down but get bigger. Hence a softer, loose soil may shake more violently than harder rock at the same distance from the same earthquake.

Other factors. Earthquake waves do not travel evenly in all directions; the orientation of the fault and the direction of movement can change the characteristics of the waves in different directions. When the earthquake rupture moves along the fault, it focuses energy in the direction it is moving so that a location in that direction will receive more shaking than a site at the same distance from the fault but in the opposite direction. This is called *directivity*. These effects are smaller than the first three factors.

Additional Dangers

LIQUEFACTION

When loose soil is shaken by an earthquake, it will compact just like shaking a canister of flour. If the soil is dry, the ground will sink a bit and foundations may be damaged. However, if the spaces between the grains of soil are filled with water, something very different happens. When the soil compacts in the few seconds of an earthquake, the water gets squeezed out from the soil but cannot flow away instantaneously. The pressure in the water goes up and pushes back on the sand. When the water pressure pushing on the grains

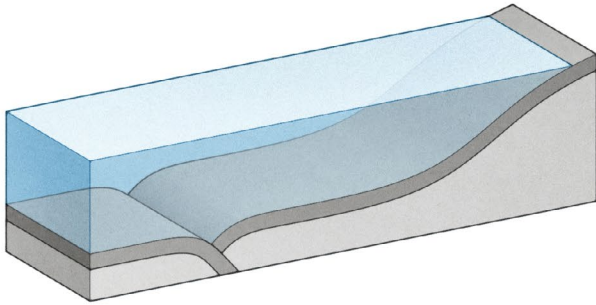
equals the pressure of the sand caused by its weight, the soil becomes a temporary quicksand in a process called *liquefaction*. It continues to act like quicksand until the water can flow away, sometimes for minutes. During that time, the soil can no longer support structures above, causing buildings to shift and sometimes sink. This action is similar to when you wiggle your toes on the wet sand on a beach, making your feet sink into the sand.

TSUNAMIS AND SEICHES

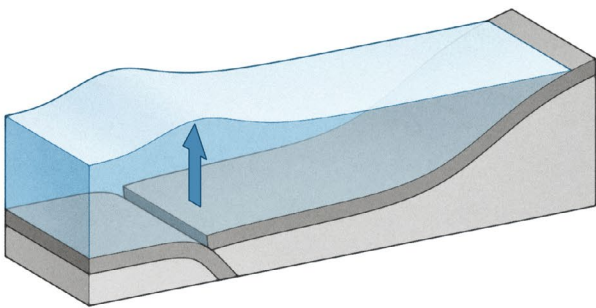
Tsunamis happen when the shape of the seafloor changes, displacing the water that is on top of it. The two primary sources are a thrust fault, which pushes one side of a fault up and over the other side effectively pushing up the seafloor, or an underwater landslide due to shaking. The size of the tsunami is based on how much water is displaced. A landslide that occurs under water can cause a big displacement over a relatively small area, making a large, but very local, tsunami. The longest and biggest thrust faults are at *subduction zones*, which can push up the seafloor over a very large area. Those faults can be hundreds to as much as a thousand miles long, and a hundred or more miles wide. That whole block of rock will move tens of feet in the earthquake, displacing a huge volume of water. Those waves then move out across the ocean, getting smaller as they spread. Only the largest earthquakes, over magnitude 8.5, and especially over magnitude 9.0, create tsunamis large enough to cause damage on the other side of the ocean.

A seiche is similar a tsunami, but takes the form of sloshing water in closed lakes or bays and has the potential to cause serious damage, though occurrences have been very rare.

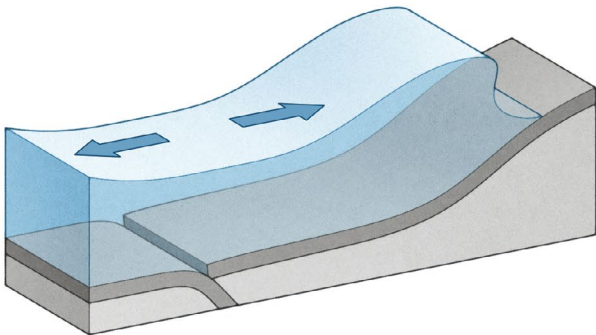
HOW TSUNAMIS ARE CREATED



Overtime, stress builds up in subduction zones lying under the ocean floor.



The stress gets released in an earthquake, which pushes up the ground. When the ground moves up, the water above it is also pushed up.



When the water goes back down, it creates a wave that moves out from the fault, generating a tsunami.

From Knowledge to Action

Many people throughout America are exposed to the risk of earthquakes. The western part of the country has the most earthquakes, sitting at the boundary between the North American and Pacific Ocean Plates. This plate boundary also has the longest faults, meaning it has the biggest earthquakes. However, as shown on the map on [page 7](#), earthquakes can occur in many areas throughout the United States.

We all face economic risk from earthquakes. A large earthquake that badly damages the economy of one area of the United States is going to cause ripple effects across the country, so we all have a stake in earthquake preparation and protection.

When large earthquakes cause damage, state, local, tribal, and territorial emergency services, with assistance from FEMA, will mobilize to help the community respond and recover. How much help is needed and how long the process takes is more complicated than just the earthquake magnitude and will depend on how bad the shaking was where people live (*intensity*). It will also depend on what the communities affected had done before the earthquake to be better prepared and protected, such as requiring buildings and infrastructure to be constructed to withstand seismic shaking through building codes and advanced engineering standards. All levels of society, government, businesses, community organizations, and individuals, can contribute to the solution. It begins by acknowledging that if we wait long enough, every one of us will be affected by earthquakes. The only random part is *when* they will happen.

Prepare



Overview

This section provides guidance for actions that you and your family can take to reduce damage and personal injury from earthquakes through preparation and planning. Also presented are recommendations for assembling and organizing disaster supplies for post-earthquake survival.

Secure Your Space

There are many simple tasks you can do to prepare for earthquakes that range from no cost do-it-yourself projects, to more involved tasks that often require assistance from outside contractors. The implementation of the tasks listed below may not represent a complete list, but when addressed, they will reduce the potential for injuries. Additionally, these tasks will also reduce damage to buildings, potentially saving property and contents.

Note that many of the tasks apply to school, office, and other spaces frequently occupied during the day as well.

NO COST TASKS:

Assess the risks in your home. Using the free publication FEMA 528, [Earthquake Home Hazard Hunt](#), identify hazards in your living room, bedroom, kitchen, and other spaces in your home. Some of the risks identified as a result of this hunt can be addressed at no cost: relocation of items is the primary no-cost strategy.

- Relocate heavy or large, loose items located high overhead (taller than 4 ft) in shelves, cabinets, and bookcases to the floor or lower shelves. Make sure that the shelves and bookcases are also restrained from falling—see [Low Cost Tasks](#) on [page 17](#).
- Relocate contents or items that can fall on you where you spend a lot of time—your bedroom (large picture frame over bed), kitchen (heavy decorations or plants on top of cabinets), and living room (tall or narrow entertainment units).
- Clear a path for at least two safe exits such that they are free and clear of contents and clutter. Relocate heavy or large, unstable furniture, or contents located in exit corridors or adjacent to exits that could move or overturn, blocking your escape routes from the area or home.
- Remove toxic and flammable materials, or limit their quantities and ensure they are safely stored to prevent spilling.

Risk at Home!

There are many contents within a home that present a potentially significant risk to your safety during and following a major earthquake. The image below shows interior damage following the 1994 Northridge Earthquake that occurred in California.



PHOTO COURTESY OF WISS, JANNEY, ELSTNER

Taking Control

While earthquakes are inevitable, the damage associated with earthquakes is not. There are many things that can be done to limit and reduce the impact of damage to property and the disruption to lives caused by that damage. *The Seven Steps to Earthquake Safety* offers additional guidance in preparing for earthquakes and specific steps to correct or mitigate the risks for many of the items discussed here: <https://www.earthquakecountry.org/sevensteps/>



PHOTO COURTESY OF EARTHQUAKE COUNTRY ALLIANCE

LOW COST TASKS:

It is a low cost task to secure items that are located high and can fall, items that can overturn and fall on you or block your exit, and items that if they fall could become damaged and create more of a financial risk than safety risk. These items include:

OBJECTS ABOVE

- Hanging lights
- Ceiling fans
- Picture frames
- Hanging mirrors
- Hanging plants
- Contents of bookcases and kitchen cabinets

TALL OBJECTS

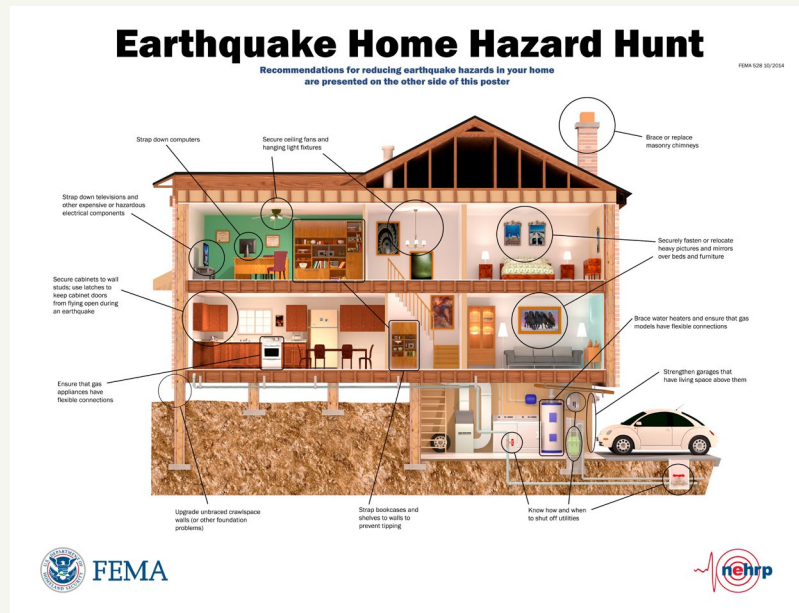
- Tall bookcases
- Refrigerators
- Armoires
- China cabinets
- Storage racks
- File cabinets
- Gym equipment
- Water heaters

TABLETOP OBJECTS

- Televisions
- Stereo systems
- Art objects
- Glassware and vases
- Computers
- Monitors
- Printers
- Speakers

FEMA 528 – Home Hazard Hunt

Perform a risk assessment of your surroundings at home, school and office, looking for common sense hazards that could cause injuries, block exit routes, or cause property damage during and following earthquakes.



FEMA 528 - EARTHQUAKE HOME HAZARD HUNT

[HTTPS://WWW.FEMA.GOV/MEDIA-LIBRARY/ASSETS/DOCUMENTS/3261](https://www.fema.gov/media-library/assets/documents/3261)

The following are low-cost tasks to reduce your risk:

- Secure or restrain hot water heaters to prevent overturning, flooding, and loss of a post-earthquake or emergency water source, as well as reduce a potential source for fire from gas-fired water heaters. See the [Protect](#) section for detailed guidance.
- Secure top-heavy furniture items adjacent to exit corridors or doors, whether or not relocation is possible. These include tall armoires, china cabinets, bookcases, kitchen ranges, refrigerators, and file cabinets. Anchor these items to wall studs directly or with straps or tethers. See [Protect](#) section for more information.
- Secure heavy mirrors and pictures with at least two support points anchored into wall studs with closed hooks.

FEMA E-74 - Reducing the Risks of Nonstructural Earthquake Damage

FEMA E-74 is a comprehensive document that explains the sources of nonstructural earthquake damage in simple terms and provides methods for reducing potential risks. Section 6.5 of FEMA E-74 includes description of do-it-yourself tasks for securing furniture and contents that are typically found in homes.



Reducing the Risks of Nonstructural Earthquake Damage - A Practical Guide

FEMA E-74 / December 2012



FEMA E-74, REDUCING THE RISKS OF NONSTRUCTURAL EARTHQUAKE DAMAGE - A PRACTICAL GUIDE

[HTTPS://WWW.FEMA.GOV/MEDIA-LIBRARY/ASSETS/DOCUMENTS/21405](https://www.fema.gov/media-library/assets/documents/21405)

- Install child-proof latches to kitchen cabinets above counter height to prevent damage and injury from falling dishes, glassware, and other contents. Consider installing latches on below-counter height cabinets as well.
- Secure electronics that could slide and fall and potentially injure you or become damaged. These include TVs, computers, printers, and table top equipment. Restraints will likely take the form of straps or tethers to the furniture or rubber type mats to prevent sliding.
- Secure valuable items to shelves and furniture with museum wax to prevent damage. Items may include vases, art objects, glassware, and lamps.

HIGHER COST TASKS:

Some tasks will be costlier to implement and will likely require assistance from a design professional and contractor. See the [Recover and Repair](#) section for guidance on managing outside assistance.

- Install flexible connections where gas lines connect to gas-fired equipment to prevent a leak and potential fire. Such equipment includes hot water heaters, appliances, overhead unit heaters, and other Heating, Ventilation, and Air Conditioning (HVAC) equipment.
- Restrain or anchor free-standing wood stoves or fireplace inserts to prevent damage and possible fires.
- Verify proper restraint or anchorage of brick or stone veneer at fireplaces to prevent collapse. Ensure items mounted to the veneer, such as mantels and TVs, are properly restrained to prevent falling.
- Verify proper restraint of heavy overhead lights and other fixtures, such as chandeliers, and add additional safety wire restraints to prevent falling.
- Properly install safety film on large glass windows or doors that could break and shatter, particularly overhead or adjacent to exit routes.

Drop, Cover, and Hold On!

Practice how to protect yourself. When the earth begins to shake, most people should:

(See [page 52](#) for other ways to be safe.)



GRAPHIC COURTESY OF EARTHQUAKE COUNTRY ALLIANCE AND SOUTHERN CALIFORNIA EARTHQUAKE CENTER
[HTTPS://WWW.SHAKEOUT.ORG](https://www.shakeout.org)

Make a Plan

Major life events, such as a wedding, benefit greatly from having thoughtfully prepared plans well before the event happens. An earthquake plan for the protection of yourself, family, and others in your community is no different. A major earthquake will shake you literally and mentally. A plan to reduce consequences of possible outcomes developed prior to the event will provide greater comfort and control to the extent possible. This will allow you to respond to the event faster, and realize a likely quicker and less costly recovery. The following list is by no means a comprehensive set of tasks, but includes items to consider while developing your preparedness plan. More information on preparedness planning can be found at www.Ready.gov/plan.

PLAN ESSENTIALS:

- Learn and practice “Drop, Cover, and Hold On.”
- Participate in your state or region’s Great ShakeOut earthquake drill (at home, work, or school). See <https://www.Shakeout.org>.
- Gather and record important emergency numbers and addresses including contacts.
- Identify safe spots or areas in your home and around other buildings you frequent, such as a school or office. Safe areas include sturdy tables or desks, open areas beneath counters, near an inside wall free of contents. If you are outside, locate an open area away from power lines, bridges, and windows, façades or other architectural elements that could fall off of buildings.
- Prepare a first aid kit that is readily accessible. Take a first aid, Cardiopulmonary Resuscitation (CPR), [Until Help Arrives](https://community.fema.gov/until-help-arrives) (<https://community.fema.gov/until-help-arrives>), or [Community Emergency Response Team \(CERT\)](#) training course. Download a first aid application to your smart phone.
- Keep a flashlight with fresh batteries and a pair of sturdy shoes by each bed in your home. Consider keeping sturdy shoes and a working flashlight at your office and in your car.
- Determine if you live or work in a tsunami or seiche inundation zone and make sure everyone knows the evacuation sirens and shortest routes to higher ground or designated vertical evacuation area. Refer to [Earthquakes Across America](#) for information on tsunamis. Check with local government emergency management officials or building department to determine the level of risk of tsunami or seiche inundation.
- Identify the locations of your home electrical panel and shut-off valves for water and gas. Know how to shut off each utility if you detect potential damage following an earthquake, and ensure all family members are trained.
- Ensure that your home has working smoke, gas, CO and CO₂ detectors, and replace batteries as recommended.

FEMA B-526

FEMA B-526 *Earthquake Safety Checklist* is a resource that provides a quick reference guide to begin the development of your Plan:



FEMA B-526 - EARTHQUAKE SAFETY CHECKLIST
[HTTPS://WWW.FEMA.GOV/MEDIA-LIBRARY/ASSETS/DOCUMENTS/3234](https://www.fema.gov/media-library/assets/documents/3234)

» Have a gas shut-off wrench readily available and preferably near the shut-off valve. Turn the gas off only if you smell or hear leaking gas or see the meter turning quickly. Keep in mind that if the gas is shut off, you will have to wait for the local utility to turn the gas back on and relight the gas appliances in your home. Refer to the checklist in the *Respond* section for more information.

- If you or a family member is a person with a disability or has special needs requiring additional assistance, work with your family or personal support network to include them as part of your plan.
- Include in your plan the possibility that you will have to survive in your home for at least three days, with a week being a more realistic duration. A large earthquake will strain local emergency services and time will be required to mobilize and move emergency crews from outside of the affected area into damaged areas. Routes away from your home or workplace may also be blocked, requiring extra time for emergency

services to reach your area. See the *Organize Disaster Supplies* recommendations in this section.

- Be informed about the earthquake plan developed by your children's school or day care. Keep your children's school emergency release card current.
- Keep copies of essential documents, such as identification, insurance policies, and financial records, in a secure, waterproof container, and keep copies of the essential documents with your disaster supplies. Include a household inventory of your belongings in the form of a list, photos, or video on record.
- Designate one or two people in your family with the responsibility of taking the disaster supplies and essential documents if evacuation is necessary.
- Consider a plan to maintain your car's fuel supply to be more than half a tank. This is because a large earthquake can easily disrupt area utilities and prevent you from being able to pump fuel for an extended period of time.
- Consider purchasing earthquake insurance to protect the financial investment you have in your home and personal property. Your homeowner and rental insurance policies will not cover earthquake losses. See the *Protect* section for more information on earthquake insurance and refer to [FEMA's Earthquake Infographic](#) in the *Resources* section.
- Review and practice your plan regularly. An annual review with your family would be a suggested minimum time frame to consider.
- Download and complete FEMA B-526, [Earthquake Safety Checklist](#).

POST-EVENT COMMUNICATION AND REUNIFICATION PLAN:

- Select a meeting location near your home where all family members can gather if your home is not accessible.

Primary Communication Safety Contact

Pick a primary communication safety contact outside of the likely affected region of strong shaking.



- Provide all family members with a list of important contact numbers. Besides all family member numbers, local police and fire department and emergency management department phone numbers may be helpful following the disaster as it is likely that the emergency 911 number will be overloaded.
- Designate a primary communication safety contact. Identify a family member, relative or friend who is geographically located a large distance from your home's location as an emergency contact that all family members can check in with to communicate each other's safety status and location. Also note that both phone or text communication mediums should be tried as they operate via separate systems. Text is more likely to function during times of high usage than phone.
- In addition to prearranging a primary communication safety contact, it is also a good idea to let loved ones

know if you are planning to use a social media platform or other means to keep them informed after an event. For example, the American Red Cross maintains [Safe and Well](#), a web-based system that helps reunite friends and family displaced by a disaster. The Safe and Well site is always available and can be used by the public for any disaster, large or small.

- Purchase and learn how to use an emergency or weather radio with the public alert feature to obtain information on hazards and other emergency status information.

PLAN FOR TRAVELING TO EARTHQUAKE PRONE REGIONS:

Review and understand the earthquake risk of the region to which you are traveling. Is it a high seismic region where more planning and caution should be exercised? The *Supplement: Earthquakes Across America* section provides a good primer on various regions of the country that are seismically active and what hazards should be considered applicable to the region.

Emergency Radio

Consider buying an emergency radio with solar or wind-up power capabilities.



Areas to Avoid

INDOORS

Tall furniture, televisions, hanging objects, mirrors, windows, and exterior-facing walls may fall or break, unless secured. Move a few feet to avoid such dangers then Drop, Cover, and Hold On.

OUTDOORS

Nearby buildings, power lines, trees, signs, vehicles, and other hazards may fall or be thrown at you. Move to a clear area if safe to do so, then Drop, Cover, and Hold On.

Refer to the *Survive* section on [page 50](#).

- Develop an awareness of your surroundings. Remember that even small earthquakes can dislodge and damage contents causing potential life safety risks.
 - » Identify potential safe areas in your temporary work and living environment.
 - » Review potential exit routes out of buildings, such as emergency exits and stair wells. Identify at least two different routes. It would be beneficial to use and become familiar with one of the routes during the course of your stay if possible.
- Consider carrying a small flashlight in your luggage.

Organize Disaster Supplies

Disaster supplies should contain essential items in case area utilities and other basic services are out or your home becomes severely damaged requiring evacuation. The supplies should be assembled to provide the essentials for a duration of three days to one week. The supplies do not need to be prepared all at once, but can be assembled over time as budget permits. Above all, disaster supplies should be mobile and readily available if evacuation is necessary. Items for consideration in assembling your disaster supplies are listed next. The *Build a Kit* page of www.Ready.gov/kit can also be referenced for more information on assembling disaster supplies.

- **Water.** The recommended minimum amount of water for each person or pet is one gallon per day. This can add up quickly as a family of four will need 12 gallons of water for a three day duration. Remember that a hot water heater provides a great water source as it typically contains 40 gallons of water that can be used, provided the heater has been properly restrained and not damaged. Also consider storing water purification tablets.

Disaster Supplies

Essential disaster supplies should include key items such as water, food, medical supplies, safety items, personal and comfort items to ease recovery following a major disaster.



- **Food.** Assemble and store at least a three day supply of non-perishable food, such as dehydrated or canned foods, for members of your family. Include a manual can opener for canned items. Include food for those with dietary needs as well as pets.
- **Medical Supplies.** Include a first aid kit with a medical book (download a basic first aid application to your phone). Include prescription and non-prescription or over-the-counter medications and other immediate medical supplies required by anyone in the household. Include copies of medical consent forms for dependents.
- **Safety Items.** Include flash lights with spare batteries, light sticks, and emergency or weather radio with the Public Alert feature and extra batteries. In addition, include a charged battery block or solar battery chargers for cell phones, and a fire extinguisher that is readily accessible to douse potential post-earthquake fires. Other items include a whistle on a lanyard, gloves, gas shut-off or crescent wrench, small hand saw, small pry bar, and rope.
- **Personal Items.** Include some emergency cash with your disaster supplies as ATMs may not be functioning. Small bills are advised as change may not be available. Include other personal items particular to each family member, such as spare eyeglasses and contacts, blankets, and clothing particular to your regional climate, such as extra shoes, long sleeve shirts, pants, and jackets. Include copies of vital documents including driver licenses, passports, and insurance policies. In addition, keep your camping equipment, such as sleeping bags and portable stoves, accessible as these will become useful if utilities have been damaged.
- **Sanitation.** Include several rolls of toilet paper, bar soap in a plastic container, small packs of face tissue, plastic bags (large and small), hand sanitizer, and towelettes. Keeping a small portable camping toilet or bucket with toilet seat stored in the garage or other storage area would be useful if the sewer system is not operational.
- **Comfort Items.** Consider including items that would provide comfort in the high stress environment post disaster. Items such as comfort foods, games, crayons, writing materials, and small outgrown stuffed toys for children who may regress under stress can help family members cope better with the consequences of the disaster.
- **Car and Office Supplies.** Assemble disaster supplies in smaller amounts of the above items and store in your car and office.
- **Storage Suggestions.** Store as much of the above in a central, dry, and easily accessible area. For mobility, consider storing much of the contents in backpacks or duffle bags that can be easily gathered in an emergency. Large plastic storage bags, containers, or bins are inexpensive and good for organizing and storing many of the above supplies.

Protect



Overview

In this section, you will learn how to quickly determine vulnerabilities of your home to earthquakes and identify measures that can be taken to address them before the next earthquake. These vulnerabilities vary from affecting the overall home to affecting a portion of the home. The risk associated with the vulnerability may vary from small to extensive damage and home uninhabitability to the potential for serious injury or loss of life.

Many homes have more than one of the vulnerabilities identified within this section and prioritizing which one to tackle first, or at all, can become daunting. Although all vulnerabilities discussed have historically led to earthquake damage and should be addressed, some conditions, such as unbraced water heaters and inflexible gas and water connections, are relatively inexpensive to upgrade and should be the highest priority. The table on [page 27, *Earthquake Strengthening Projects*](#), is organized in order of project size (small, medium, or large) based on cost and complexity. Included in the recommendations is information on whether addressing the vulnerability could be a do-it-yourself project, or whether contractors, architects, or engineers might need to be involved. The table also specifies if “off-the-shelf” or prescriptive solutions are available to aid a particular strengthening project. If you are a renter, ask your landlord about the safety of your building and encourage any needed updates or repairs.

Fallacy of Earthquake Proofing

- There is no such thing as “earthquake proof.”
- Even homes designed to the latest building codes may sustain earthquake damage.
- Homes that have fared well in past earthquakes may not have been in the area of highest shaking.

Earthquake Insurance

If you live in earthquake country, one of the decisions you will inevitably face is whether or not to purchase earthquake insurance. Although most consider the West Coast earthquake country, the fact is that 37 states and territories are considered to have moderate to very high risk from damaging earthquakes. In addition to taking actions by following the guidance in the *Prepare* section or by undertaking earthquake strengthening projects in your home as addressed in this section, purchasing earthquake insurance should be considered.

Insurance is about protecting the financial investment you have in your home and personal property. Damage to your home and personal property caused by an earthquake is not covered by a standard homeowners’ residential or fire insurance policy. By not having earthquake insurance, you place yourself at risk of losing everything you own, or sustaining enough damage to your property that you cannot afford to repair if your home is jolted by a major earthquake. Without earthquake insurance, you will be responsible for all costs to repair and rebuild your home, and also for the costs associated with replacing personal property and to live elsewhere, if necessary. Even if you retrofit your home and the structure is not damaged, you are still at risk for damaged contents and personal property. While federal disaster assistance provides temporary support if you cannot use your home as well as low interest loans if you do not have insurance, it is recommended to obtain home insurance to provide the appropriate amount of

Did you know?

Most renters’ policies do not cover earthquake damage to your belongings—neither will your landlord’s policy.

protection for your property.

Renters may also want to consider earthquake insurance as most renters’ policies do not cover earthquake damage to belongings. In most cases, neither will your landlord’s policy. These policies also will not help with living expenses if you need to move out temporarily following an earthquake. It is important to identify what matters most for your immediate and long-term needs following an earthquake and obtaining additional insurance policies to address those needs.

Earthquake Strengthening Projects

The following pages present basic information on how to identify vulnerabilities and why they matter. Each project description also includes an explanation of common retrofit solutions, and if available, prescriptive or “off-the-shelf” retrofit plans that may be implemented directly by a general contractor without the need for the services of a design professional (licensed contractor, engineer, or architect). For small and medium projects that you can complete on your own, illustrative descriptions are provided for minimum requirements. For projects that would benefit from professional assistance, the illustrations and discussion can be informative. Additional resources and information are provided in the *Resources* section, where available. The decision to engage a design professional or not depends on the scope of the project, the severity of the vulnerability, and your skill level specific to retrofit projects.

Homeowners are strongly advised to visit their local building department prior to starting any retrofit work, especially where they intend to perform the work themselves or use any prescriptive plans. The building department may also be able to tell you the year your home was constructed, and whether your home was built under a code that considered specific building vulnerabilities. Many of the home strengthening projects may apply to multi-family housing or condominiums. Tenants are encouraged to inquire with their landlord about any actions that are being taken to assess and retrofit homes that fall into any of the following categories.

Earthquake Strengthening Projects

Retrofit Project	Page	Do-it-yourself	Contractor may be required	Design professional may be required	“Off-the-shelf” or prescriptive solutions available
SMALL PROJECTS					
Restrain Free-Standing Water Heater	28	●	●		●
Anchor Elevated Decks, Porches, Trellises, and Carports	30	●	●	●	
MEDIUM PROJECTS					
Strengthen Weak Cripple Walls and Anchor Floors	34	●	●	●	●
Strengthen Improperly Nailed Plywood Siding	36	●	●		
LARGE PROJECTS					
Strengthen Hillside Home Anchorage to Foundations	38		●	●	
Strengthen Garage in Living-Space-over-Garage Homes	40		●	●	●
Brace Homes Supported on Post and Piers	42		●	●	●
Strengthen Homes with Unreinforced Masonry Walls	44		●	●	
Strengthen Unreinforced Stone or Masonry Foundations	46		●	●	
Retrofit Masonry Chimneys	48		●	●	●



SMALL PROJECT

- High priority
- Do-it-yourself
- Plumber recommended
- Restraint kits available

Restrain Free-Standing Water Heaters

If you don't do anything else, do this!

How to Identify

- Water heater is free standing with no strap-type restraint or bracing to adjacent building walls.
- Gas lines are rigidly connected to water heater without flexible joints.
- Cold and hot water lines are rigidly connected to water heater without flexible joints

Why it Matters

- Water heaters are a common source of damage, ranging from fire ignited by damaged gas lines, to water damage that occurs when the tank fractures and leaks.
- Water heaters are also a source of emergency water following an earthquake if the utilities have been damaged. This is applicable to both gas-fired and electric water heaters.
- Damaged exhaust flues for gas-fired heaters could allow carbon monoxide to build up in the home.

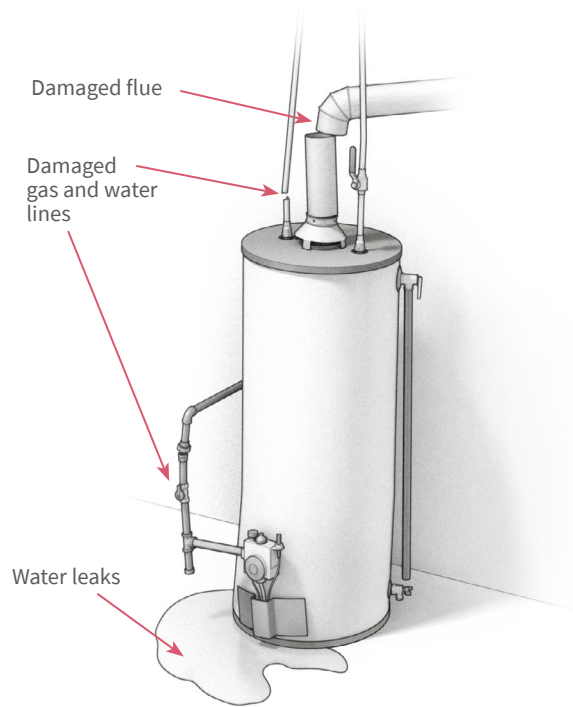
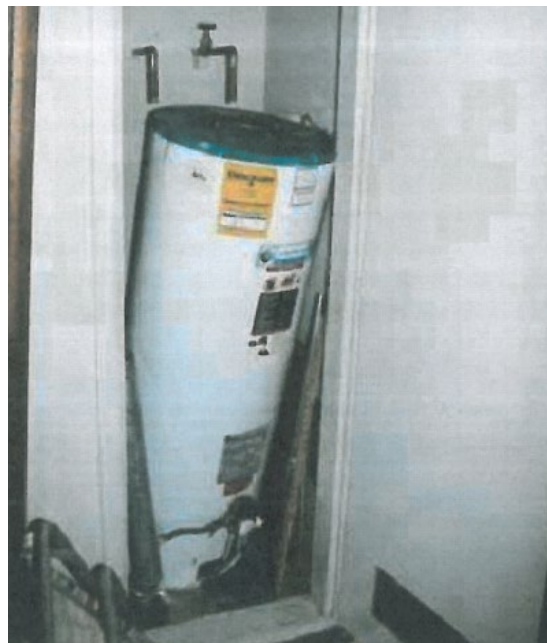


Photo of water heater failure in 1994 Northridge Earthquake. COURTESY OF EXPONENT





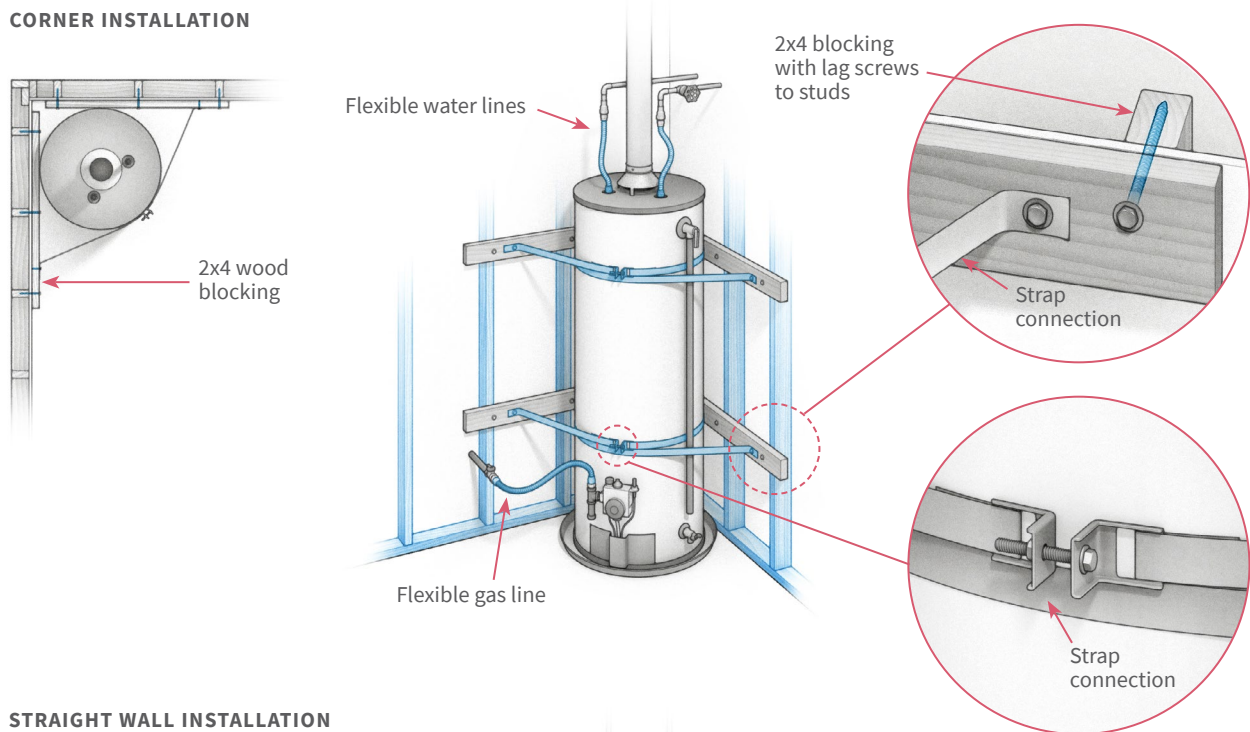
Common Retrofit Solutions

- The water heater should be braced to adjacent walls and flexible lines should be provided for water and gas connections.
- Restraining or bracing water heaters is relatively easy and inexpensive, with premanufactured seismic strapping kits available at many local hardware stores or online. The figures show a common technique for restraining a water heater located at a corner or located along a straight wall.

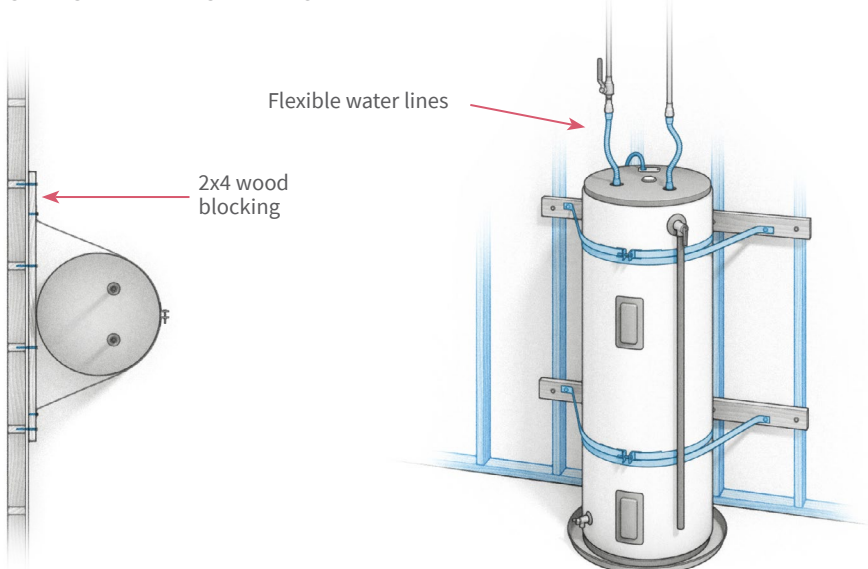
In both conditions, 2×4 wood blocking is attached to the wall studs with lag bolts. The 2×4 blocking is used to fill the gap between the water heater tank and the wall such that the water tank can be pulled tight to the blocking with strapping to prevent movement.

- Installing flexible connections is a relatively simple task; however, a licensed plumber is recommended and may be required by local building departments.

CORNER INSTALLATION



STRAIGHT WALL INSTALLATION





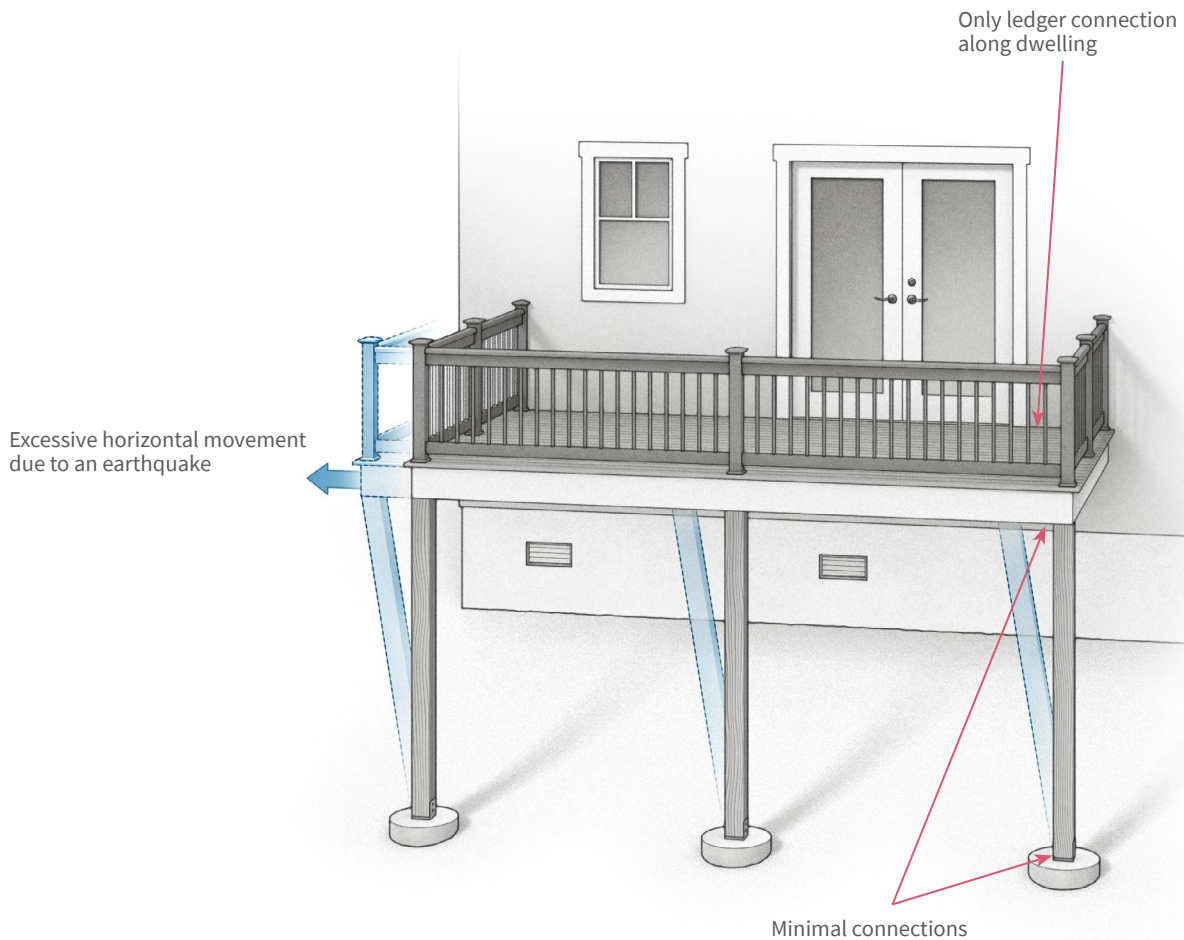
SMALL PROJECT

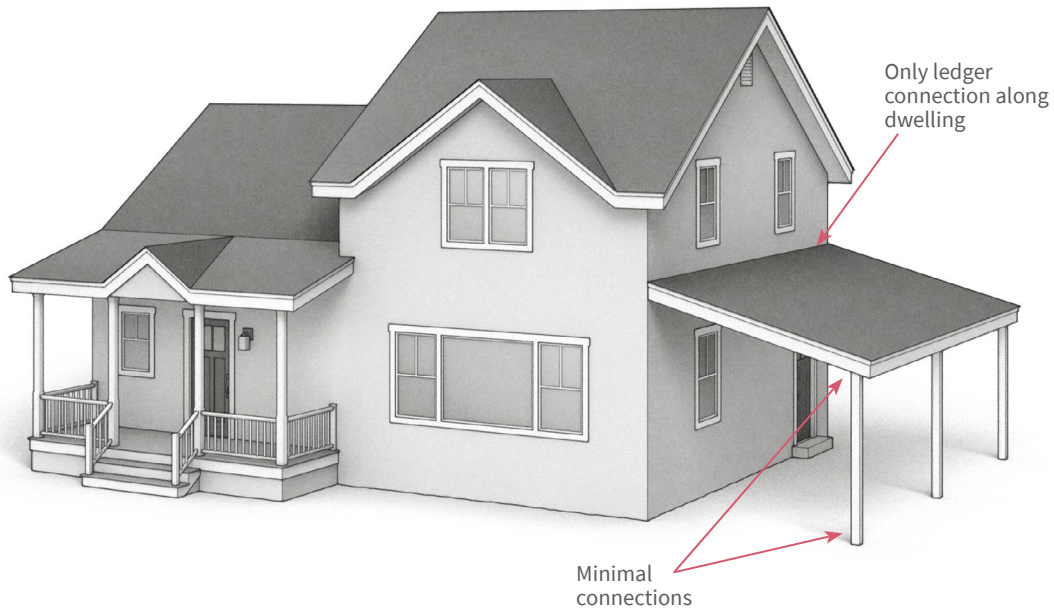
- Do-it-yourself
- Contractor may be required
- Design professional may be required

Anchor Elevated Decks, Porches, Trellises, and Carports

How to Identify

- Elevated exterior decks, large projecting roof systems, and carports or trellises are either completely free-standing or attached to the house on only one side.
- Often these structures have minimal or no obvious horizontal bracing that would help prevent excessive sideways motion and possible collapse.





Why it Matters

- Elevated decks, porch roofs, carports, and trellises can endanger lives if not properly braced, anchored to the ground, or firmly secured to an adjacent dwelling.
- Elevated decks are often only nominally fastened to the dwelling that is supporting them and may separate from the house and possibly collapse under large sideways motion that is likely with moderate to high earthquake shaking.
- Carports, large porch overhangs, and trellises can also move excessively and possibly collapse during an earthquake, especially where they are completely free-standing or minimally attached to an adjacent dwelling. Failed components can also block exit pathways.



PHOTO COURTESY OF RONALD GALLAGHER



PHOTO COURTESY OF RUSSELL GREEN

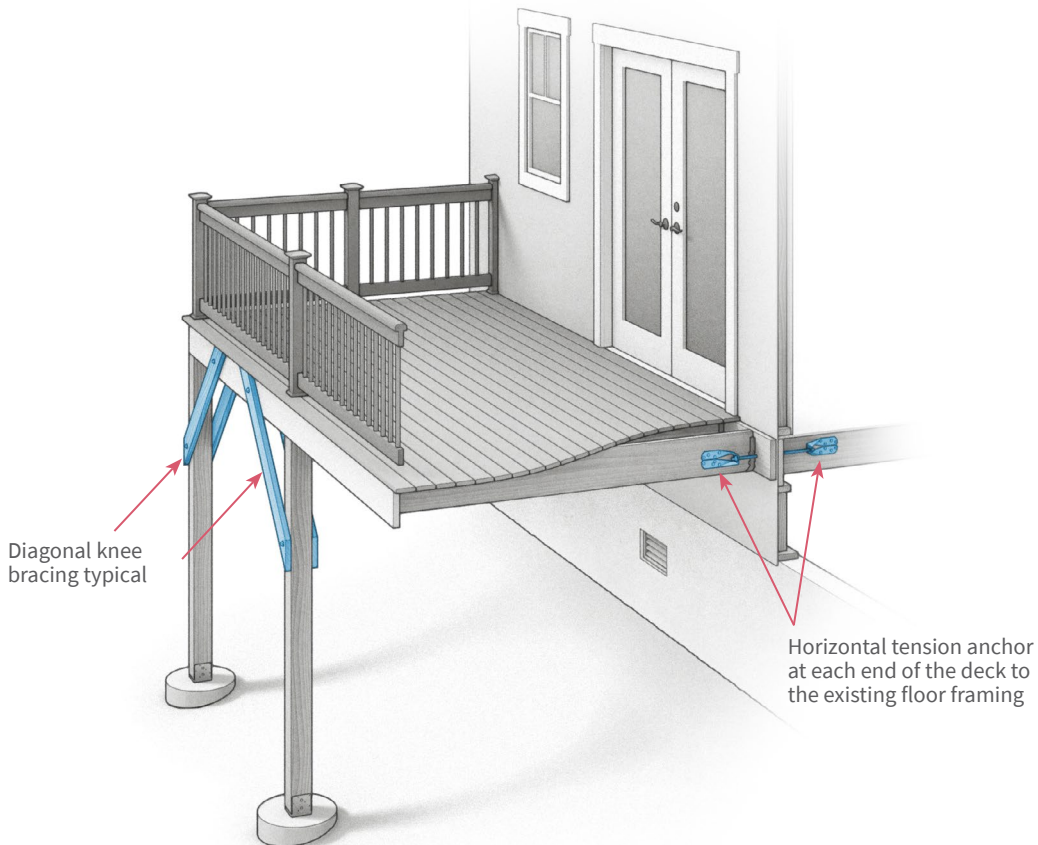


Anchor Elevated Decks, Porches, Trellises, and Carports (Continued)

Common Retrofit Solutions

ELEVATED DECKS

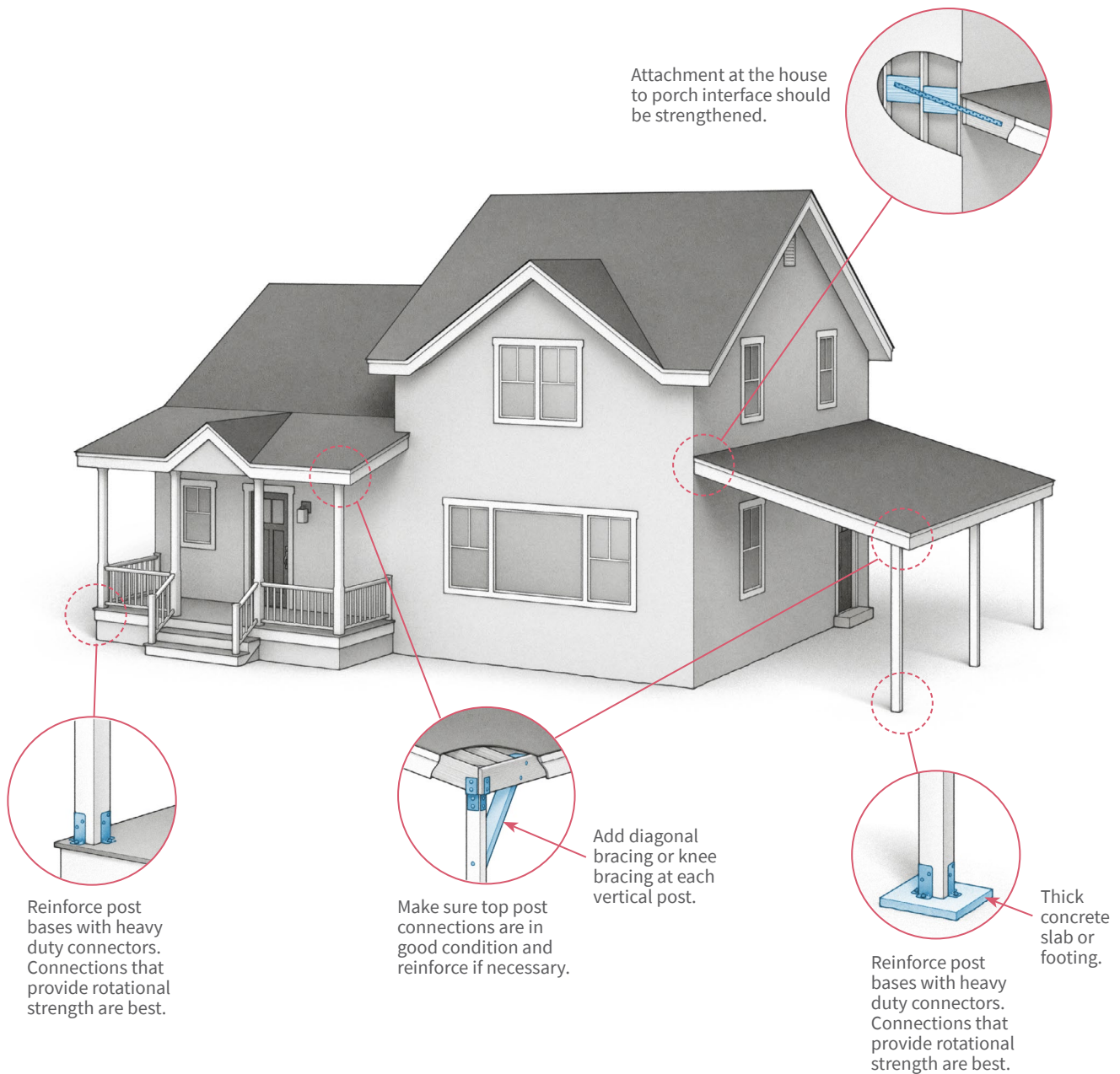
- Where properly constructed, diagonal bracing can be added to the end of the deck (opposite the house) to help prevent excessive sideways movement, associated damage, and in extreme cases, collapse.
- Installing horizontal tension anchors perpendicular to the home's exterior wall at each end can also help control excessive sideways movement and help prevent the deck from separating away from the home.
- It is anticipated that the strengthening of elevated decks, carports, trellises, and porches could be performed by an experienced homeowner with construction knowledge. A general contractor and possibly a design professional should be consulted in situations where these appurtenances are large or complicated, and where the homeowner is uncomfortable with connections to the existing dwelling including re-establishing adequate weather protection.





CARPORTS, TRELLISES, AND PORCHES

- Diagonal bracing should be added to prevent excessive sideways motion and possible collapse. Where vertical posts are rigidly attached at the base (similar to a flag pole), diagonal bracing may not be needed.
- Top and bottom connections of supporting columns should also be reinforced with the appropriate metal connectors to provide additional strength.
- Porch overhangs can also pose risk to life-safety especially when they are heavy and extend well beyond the exterior wall of the dwelling. Similar to decks and carports, horizontal tension anchor attachments at the house to porch interface, as well as metal connectors at the top and bottom of columns, should be strengthened.





MEDIUM PROJECT

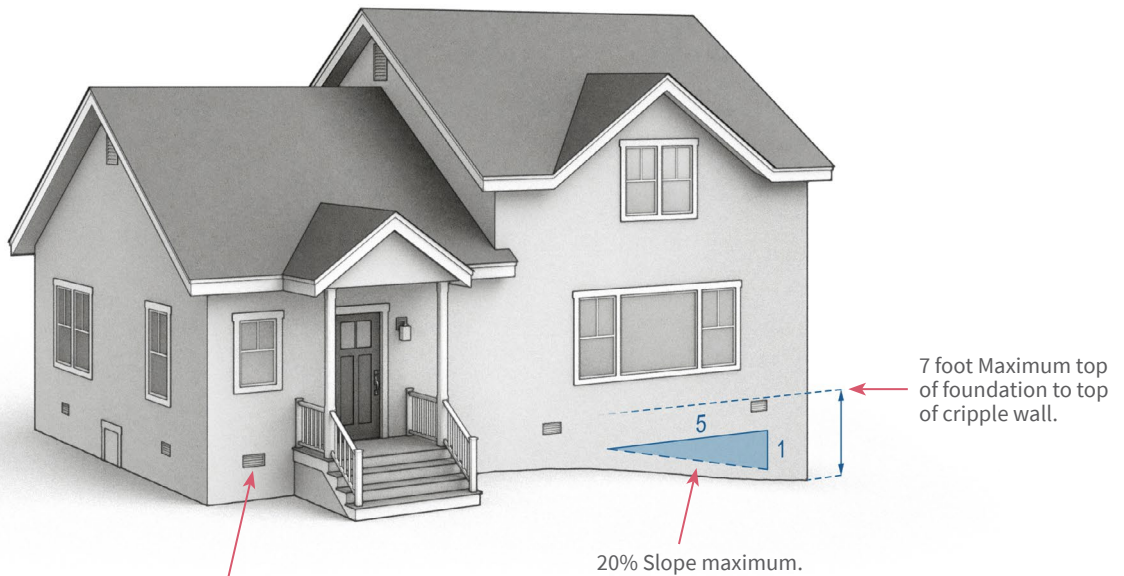
- Do-it-yourself
- Contractor may be required
- Design professional may be required
- Prescriptive plans available

Strengthen Weak Cripple Walls and Anchor Floors

How to Identify

- A cripple wall is a short, flexible wood foundation wall on the first floor that is vulnerable to damage during earthquake shaking.
- First floor is raised above the ground and either sits directly on perimeter concrete or masonry foundations, stem walls, or basement walls possibly in combination with wood stud walls not taller than 7 feet. The ground slope ratio across any side of the home is not steeper than 1 vertical to 5 horizontal, AND
- Anchor bolts that attach the existing foundation sill to the existing concrete foundation are not visible, OR
- Existing anchor bolts are severely deteriorated or have a spacing greater than 6 feet on center, OR
- Exterior or interior structural sheathing, such as plywood or oriented strand board (OSB), is not visible on any cripple walls.

Where the ground slope ratio is steeper than 1 vertical in 5 horizontal or the clear height of the tallest cripple wall or post is higher than 7 feet, see *Strengthen Hillside Home Anchorage to Foundation* on page 38.



Crawlspace dwellings have the first floor raised above the existing ground. Look for ventilation openings.



Why it Matters

Inadequately anchored homes can slide off of their foundations, and inadequately braced cripple walls can rack or deflect horizontally, causing significant damage and potentially collapse.

Common Retrofit Solutions

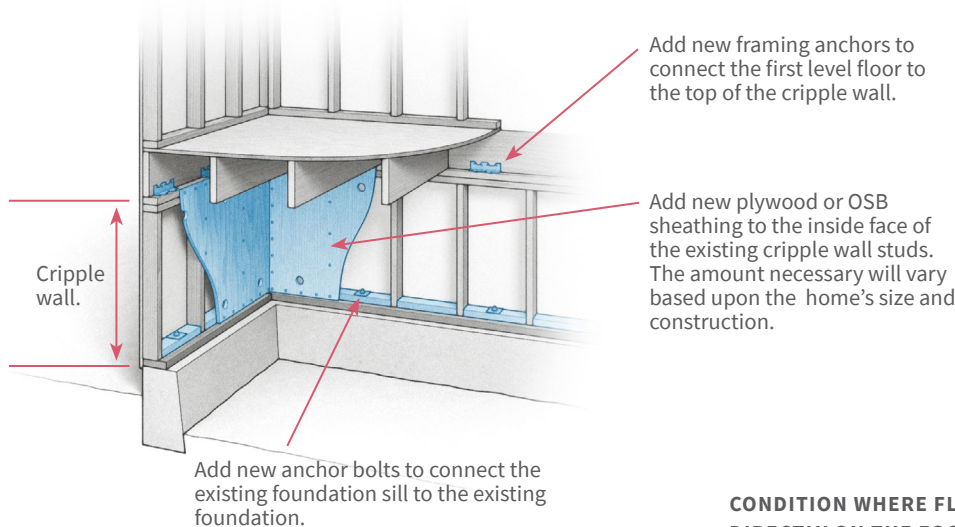
Homes with weak cripple walls can be retrofitted by strengthening cripple walls and anchoring to the foundations. FEMA P-1100, *Vulnerability-Based Seismic Assessment and Retrofit of One- and Two-Family Dwellings*, Volume 1 provides a description of the problem and retrofit solution. Volume 2A presents a prescriptive plan set for this type of retrofit. It is anticipated that these strengthening measures could be performed by an experienced homeowner with construction knowledge. However, working within a confined crawlspace can be very difficult which is why a general contractor is recommended.

Prescriptive plan sets are applicable to most homes and will save the additional cost of a design professional. Where a home falls outside the scope of these plan sets, a registered design professional should be consulted. Most plan sets contain simple screening questions that will quickly identify whether or not the plan set can be used without engaging a design professional.

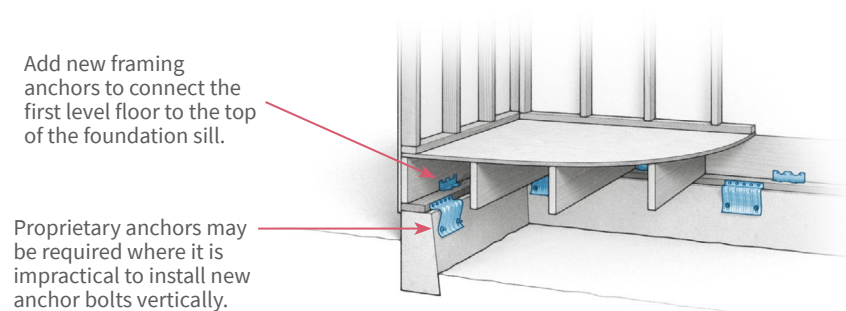


PHOTO COURTESY OF RONALD GALLAGHER

WHERE CRIPPLE WALLS EXIST:



CONDITION WHERE FLOOR FRAMING RESTS DIRECTLY ON THE FOOTING OR STEM WALL:





MEDIUM PROJECT

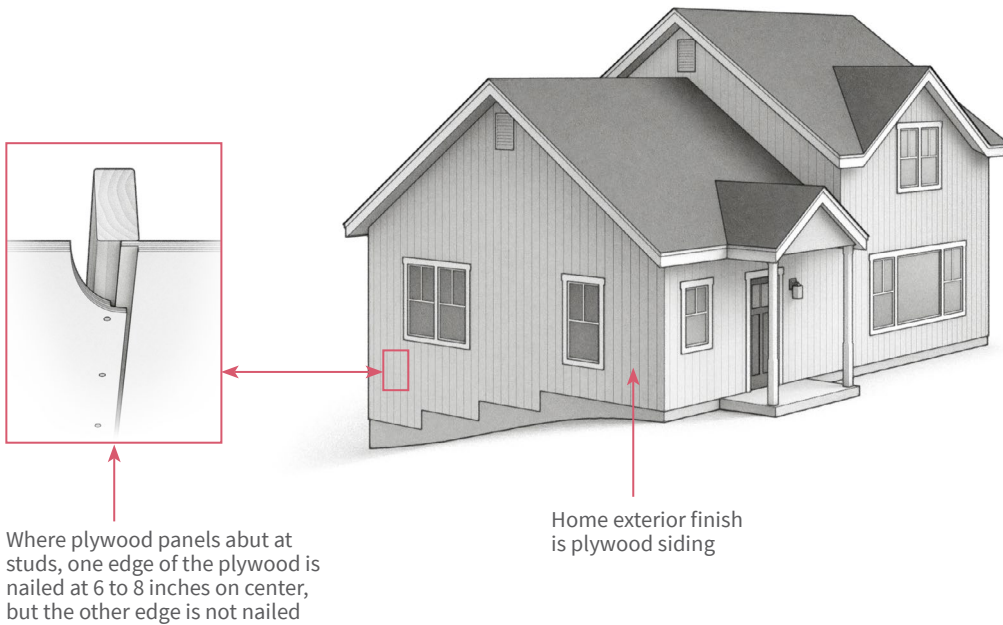
- Do-it-yourself
- Contractor may be required

Strengthen Improperly Nailed Plywood Siding

How to Identify

- Exterior walls are finished with exposed plywood siding, either flat with a rough sawn appearance, or with shallow grooves oriented vertically or diagonally at a spacing of four to eight inches on center. This siding type is relatively common in homes constructed since 1970. When looking closely, the siding can be observed to be made of sheets approximately 4 feet wide by 8 to 10 feet high.
- At the vertical joints, one of the two abutting plywood sheets can be confirmed to be nailed at 6 to 8 inches on center, but nailing of the other sheet cannot be confirmed.
- When confirming that this type of siding has been used, the panel vertical joints can be observed by looking up at the bottom edge of the siding at the foundation level. Here the siding joint should be visible.
- The row of nails on the lower panel edge, if occurs, can be confirmed visually by probing between the studs and siding from the interior face of a cripple wall, or by limited removal of the siding.

Often this condition may also be associated with hillside home vulnerabilities. See *Strengthen Hillside Home Anchorage to Foundation* on page 38.





Why it Matters

Although properly nailed plywood siding generally has the same beneficial earthquake bracing characteristics as plywood and oriented strand board (OSB) sheathing, this type of siding is often improperly nailed. Homes with this vulnerability are more susceptible to damage and possible collapse in an earthquake. For homes with crawlspace cripple walls with no interior finish (i.e., gypsum board or plaster on the inside), the plywood siding is the only available bracing, making cripple walls with improperly nailed siding particularly vulnerable to significant damage.



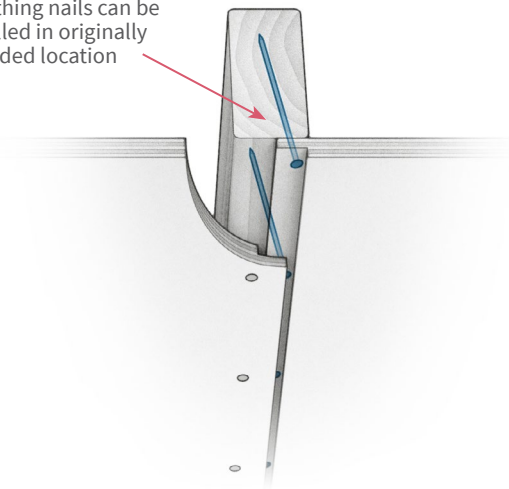
PHOTO COURTESY OF RONALD GALLAGHER

Common Retrofit Solutions

Plywood siding is retrofitted by providing additional nailing so that both panel edges are nailed to the studs behind with not less than 8 penny common nails at not more than 6 inches on center. Nailing at 4 inches on center is recommended where possible for improved earthquake bracing. Hot-dip galvanized nails should be used to reduce corrosion staining of the siding.

Where possible, the originally intended nailing can be provided (see figure below left). Where this nailing is not practical to install and there is access to the inside face of the wall, the addition of new studs inter-nailed to the existing studs can allow better access to install required edge nailing of the plywood sheet (see figure below right).

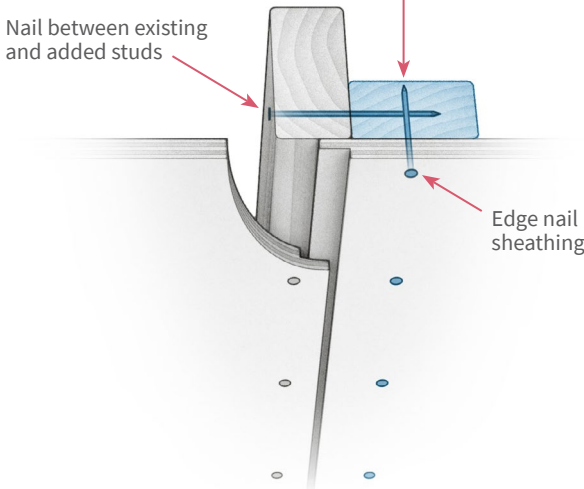
Where access is possible and studs are properly aligned, sheathing nails can be installed in originally intended location



New studs added at the inside face of the cripple walls can provide better access for new sheathing nailing

Nail between existing and added studs

Edge nail sheathing





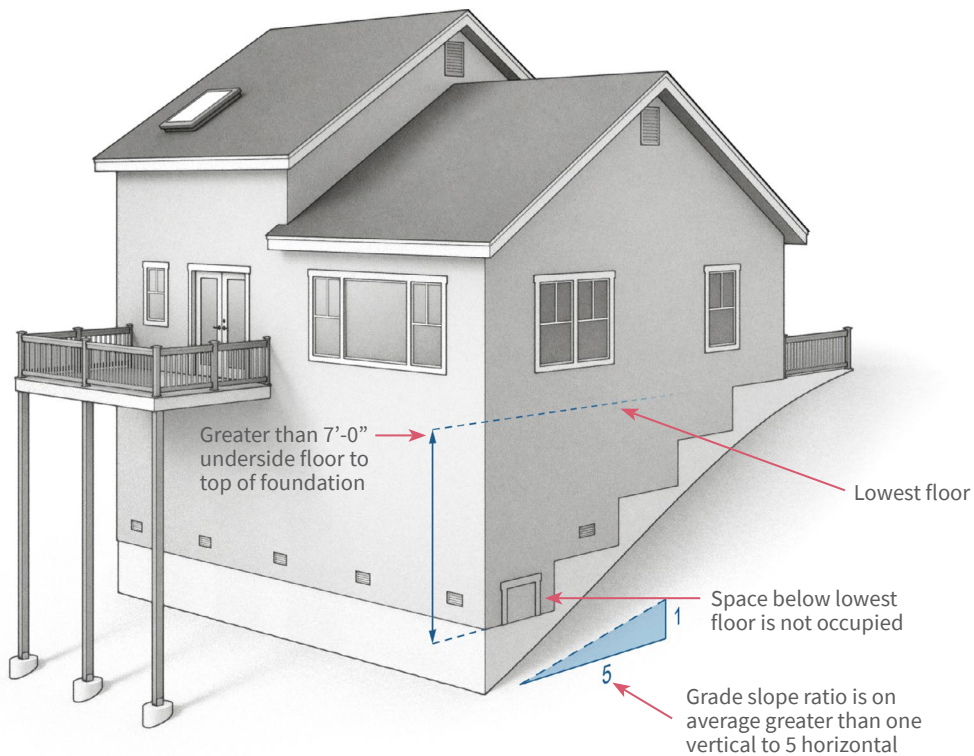
LARGE PROJECT

- Contractor may be required
- Design professional may be required

Strengthen Hillside Home Anchorage to Foundation

How to Identify

- Home is constructed projecting out over a sloping site (not tucked into the hillside), OR
 - Ground slope ratio across any side of the home is steeper than 1 vertical to 5 horizontal, OR
 - Clear height of downhill walls or posts supporting lowest floor is greater than 7 feet, OR
 - Space below lowest floor is not occupied, OR
 - Space below may be open or enclosed by walls but does not have interior wall finish materials installed (for example, wood wall studs or posts and floor framing are visible).
- Where the ground slope is less steep than 1 vertical in 5 horizontal or the clear height of the tallest cripple wall or post is less than 7 feet, see [Strengthen Weak Cripple Walls and Anchor Floors](#) on page 34.





Hillside homes collapsed in the 1994 Northridge Earthquake. PHOTO COURTESY OF CITY OF LOS ANGELES DEPARTMENT OF BUILDING AND SAFETY

Why it Matters

With earthquake ground shaking, hillside homes can pull away from the uphill foundation, resulting in significant damage and possibly collapse of the home.

Common Retrofit Solutions

Hillside homes are retrofit by strengthening the anchorage of the home to the uphill foundation and by adding or strengthening walls surrounding the under-floor space (crawl space). Strengthening work occurs primarily in the under-floor area. Retrofit elements are generally within the crawlspace and can include:

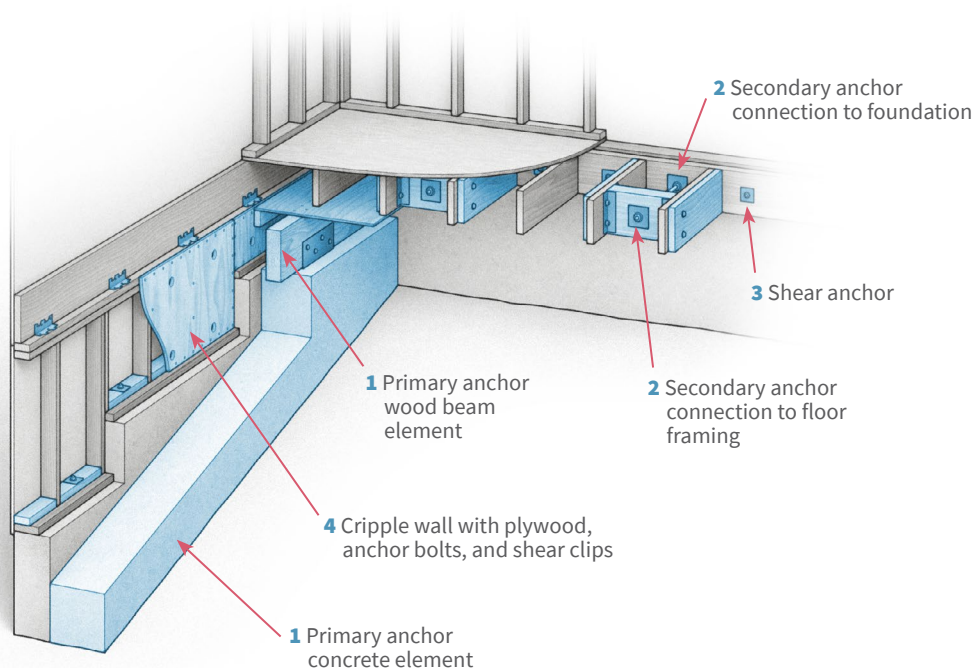
1 Primary Anchors - large tension anchors tying each end of the floor to the uphill foundation. New concrete foundation elements are sometimes added as part of this retrofit.

2 Secondary Anchors - smaller tension anchors tying the floor to the uphill foundation, occurring at a regular spacing along the entire length of the uphill foundation.

3 Shear Anchors - anchor bolts from the floor framing to the uphill foundation, occurring at a regular spacing along the entire length of the uphill foundation.

4 Sheathing, anchor bolts, and shear clips on cripple walls on all sides of the under floor crawlspace.

It is anticipated that these strengthening measures will require the services of a design professional experienced in residential construction, and of an experienced contractor. FEMA P-1100, *Vulnerability-Based Seismic Assessment and Retrofit of One- and Two-Family Dwellings*, Volume 1 provides design recommendations for this type of a retrofit.





LARGE PROJECT

- Contractor may be required
- Design professional may be required
- Prescriptive plans available

Strengthen Garage in Living-Space-over-Garage Homes

How to Identify

Living space occurs in an upper story that extends substantially or completely over a garage (or space constructed primarily as a garage, including utility and storage areas).

Why it Matters

The garage area of a home often has less earthquake bracing than other areas, particularly at the garage door opening. With earthquake ground shaking, homes with living spaces over a garage can sway sideways, resulting in significant damage and possible collapse of the home.



PHOTO COURTESY OF J.K NAKATA, AVAILABLE AT WWW.USGS.GOV, LAST ACCESSED 7/7/19



PHOTO COURTESY OF RONALD GALLAGHER



Living space in upper floor over the garage

Garage provides little or no bracing

Narrow walls at garage front provide little earthquake bracing



Common Retrofit Solutions

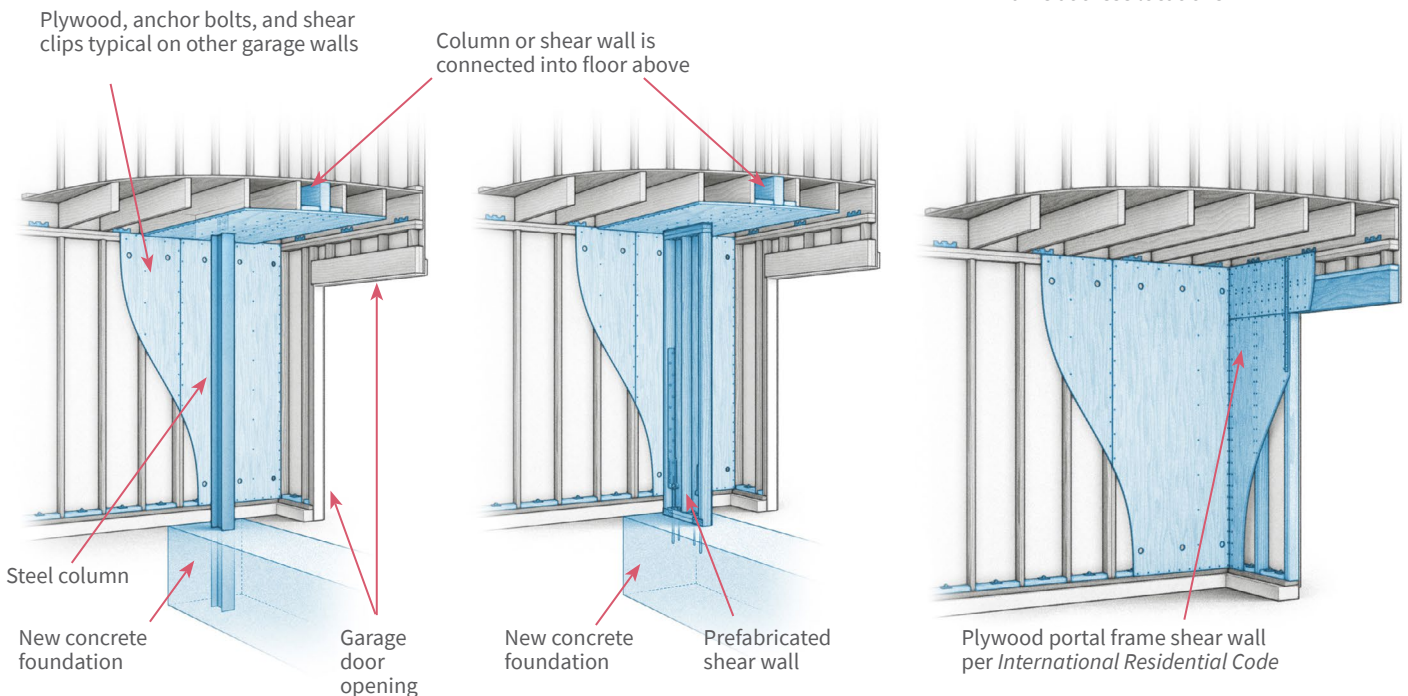
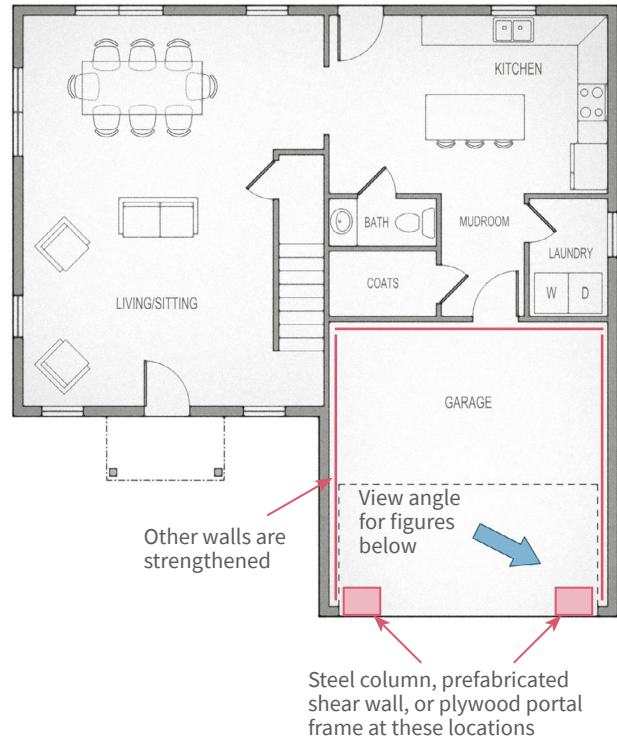
Living space over garage homes can be retrofitted by strengthening existing walls around the garage perimeter. FEMA P-1100, *Vulnerability-Based Seismic Assessment and Retrofit of One- and Two-Family Dwellings*, Volume 1 provides a description of the problem and a retrofit solution. Volume 2B presents a prescriptive plan set for this type of retrofit.

The garage plan to the right shows typical locations of retrofit. The blue arrow indicates the view seen in the figures below.

- Where the length of wall adjacent to the garage door is narrow, steel columns or prefabricated shear walls can be placed in a new foundation inside of the garage door.
- Where the length of wall adjacent to the garage door side is at least 32 inches, shear walls detailed in accordance with the *International Residential Code* can be constructed at the garage door wall.
- Plywood or oriented strand board (OSB), anchor bolts, and shear clips are provided on other garage walls.

It is anticipated that these strengthening measures will require the services of an experienced contractor.

Prescriptive plan sets are applicable to some homes and will save the additional cost of a design professional. Where the home falls outside of the scope of these plan sets, the services of a registered design professional experienced in residential construction will be required.





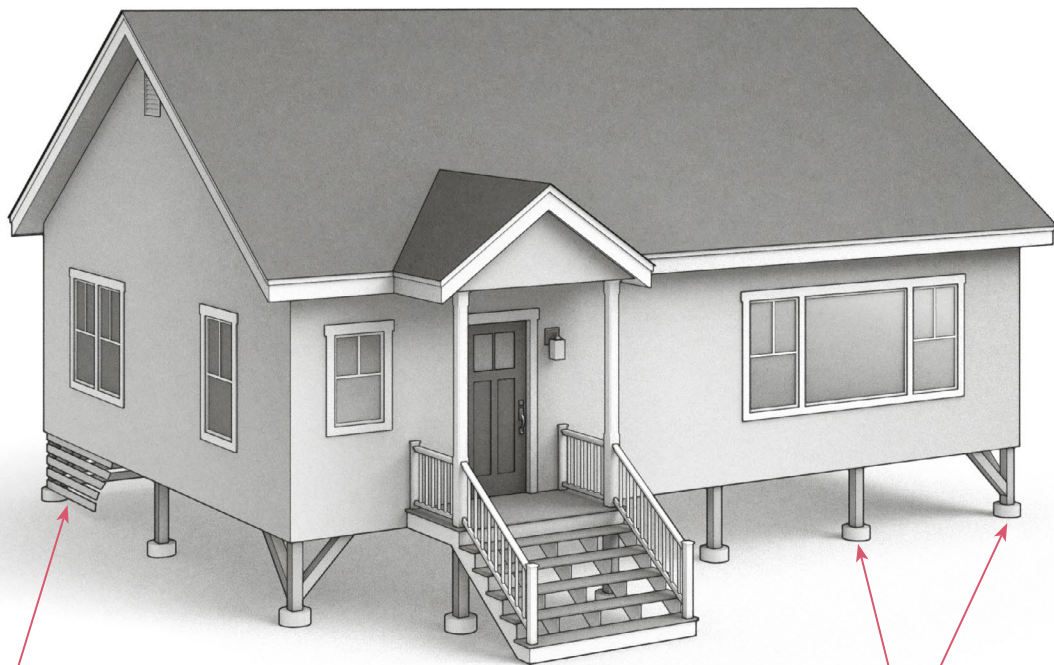
LARGE PROJECT

- Contractor may be required
- Design professional may be required
- Prescriptive plans available

Brace Homes Supported on Posts and Piers

How to Identify

Perimeter of the first floor is predominantly supported on isolated posts and piers. This could include homes in flood prone areas as well as hillside homes.



Perimeter is often covered by screening material which provides no earthquake resistance

Isolated posts with or without nominal bracing provide minimal resistance to earthquake shaking



Why it Matters

Homes supported only by posts are particularly susceptible to sideways motion and can be significantly damaged and possibly collapse during earthquakes.

Common Retrofit Solutions

Retrofit solutions include adding continuous foundation systems and sheathed cripple walls or raised concrete stem walls. See *Strengthen Weak Cripple Walls and Anchor Floors* on page 34 for additional information. If the home is located in a flood hazard area and the solid walls are used as part of the seismic retrofit, flood vents will need to be added to allow flood water to equalize pressures. These details can also be used on manufactured (mobile) homes.

Temporarily shoring the existing home and the addition of new foundations and cripple walls should only be attempted by an experienced contractor.

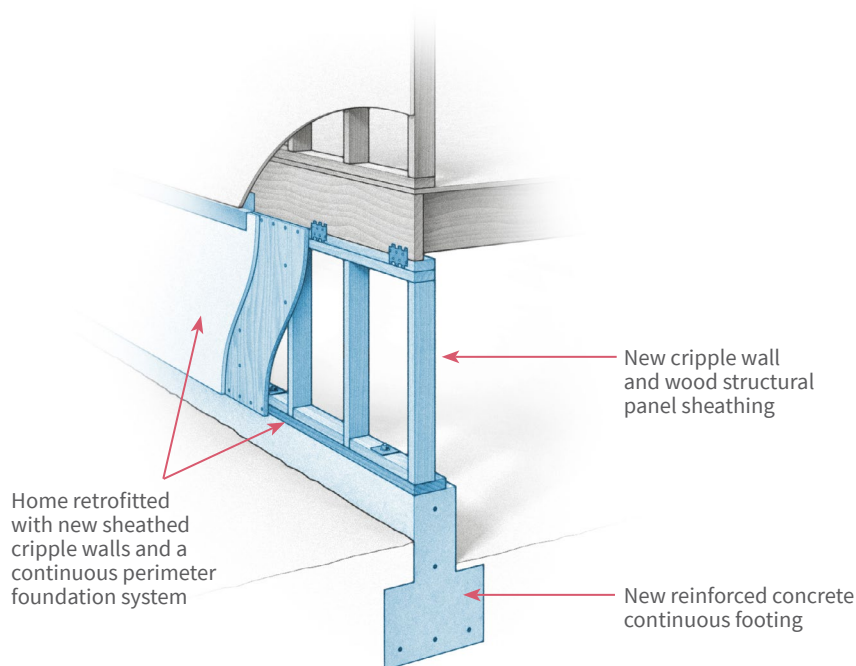
The prescriptive plan sets available for strengthening cripple walls can be applicable and will save the additional cost of a design professional. Where a home falls outside of the scope of these plan sets, a design professional will be required. Most plan sets contain simple screening questions that will quickly identify whether or not the plan set can be used without engaging a design professional.



Photo of damage to post and piers in Hawaii Earthquake. COURTESY OF IAN ROBERTSON, AVAILABLE AT WWW.EERI.ORG, LAST ACCESSED 7/7/19



PHOTO COURTESY OF KELLY COBEEN





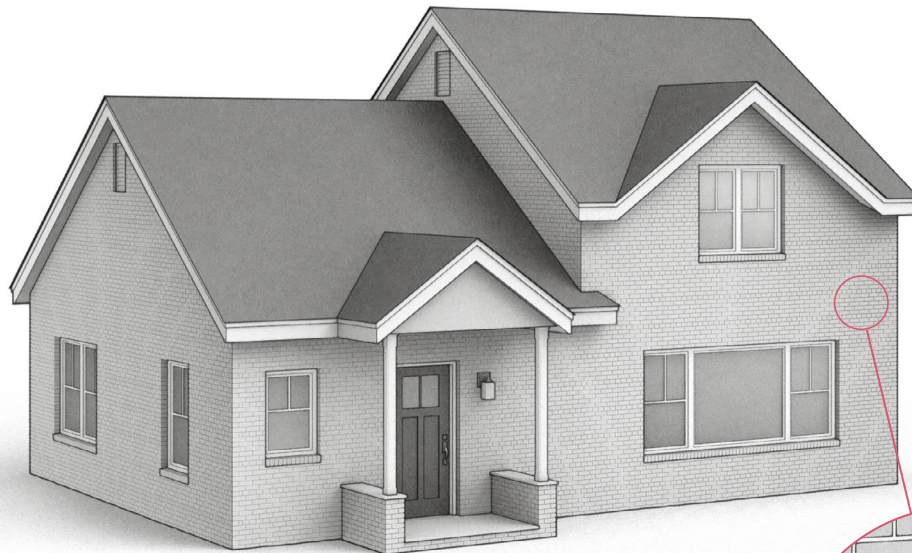
LARGE PROJECT

- High priority
- Contractor may be required
- Design professional may be required

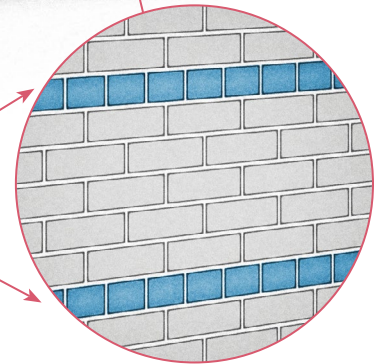
Strengthen Homes with Unreinforced Masonry Walls

How to Identify

- Older home with exterior and possibly interior walls constructed from unreinforced brick masonry (URM), concrete masonry units (CMU), hollow clay tiles, or adobe.
- Unreinforced masonry walls have header courses that are usually placed endwise every 5-6 rows of brick. These are used to tie the outer and inner layers of brick together.



Header courses





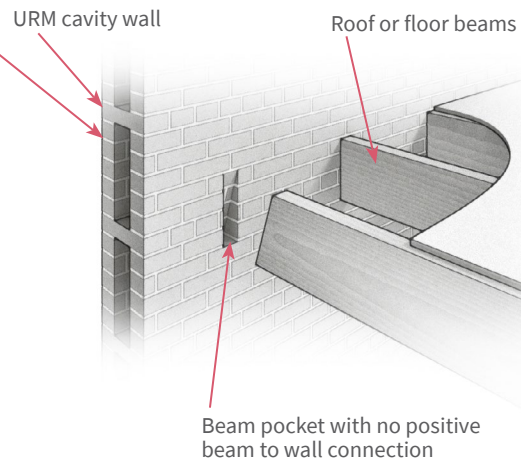
Why it Matters

- In these types of homes, the attachment of the structural elements (floor and roof beams, walls) is generally lacking. In addition, the mortar or glue that holds the bricks or stones together has limited capacity and often fails during strong ground shaking. Where mortar has deteriorated, this bond is even weaker and more susceptible to breaking.



Photo of damage to masonry building in Christchurch. COURTESY OF FRED TURNER, AVAILABLE AT WWW.EERI.ORG, LAST ACCESSED 8/3/19

- Without horizontal and vertical steel reinforcing, masonry, stone, and adobe have very limited strength to resist the pushing and pulling forces that occur during earthquakes. Heavy exterior walls can detach from the wood roof and floor beam systems due to out-of-plane (outward) movement and can collapse.
- Parapets can move and displace in an earthquake and fall to the ground as well as compromise the roof-to-wall connections. The taller the parapet the more vulnerable it is to collapse.



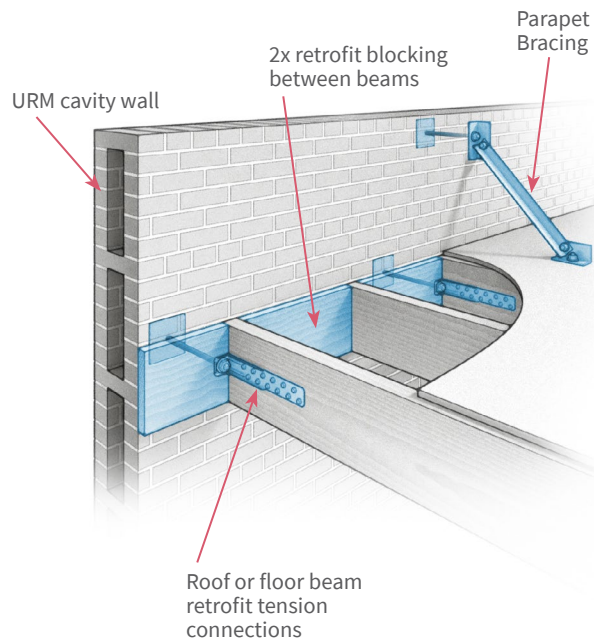
Common Retrofit Solutions

Retrofit solutions for homes with walls constructed from unreinforced masonry generally include:

- Brace parapets.
- Install new tension anchors from the walls to the roof and floor framing where applicable.
- Strengthen tall walls for out-of-plane and in-plane response. Out-of-plane wall strengthening can include new interior steel beams and columns to reduce the horizontal or vertical span of the walls to a length where excessive tension cracking and failure is unlikely. In-plane wall strengthening can include the addition of new concrete walls dependent upon both the amount of solid wall available as well as existing mortar condition.

Strengthening unreinforced masonry walls can become a large and complicated project. A knowledgeable general contractor is recommended. Additionally, a design professional should be consulted to develop the necessary strengthening design and construction drawings and details.

ROOF PARAPET WALL BRACING RETROFIT





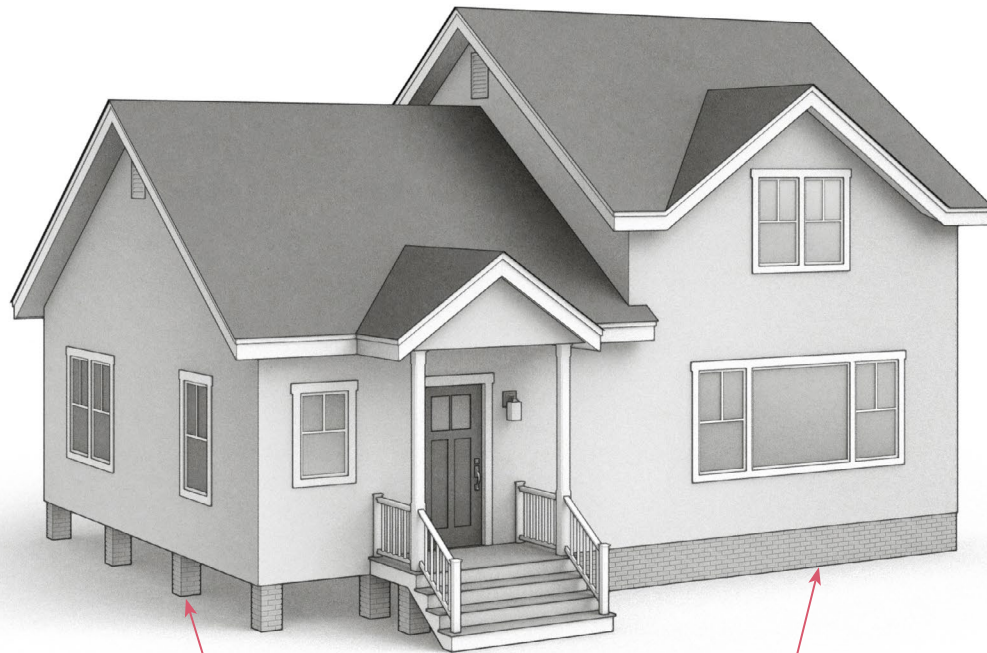
LARGE PROJECT

- Contractor may be required
- Design professional may be required

Strengthen Unreinforced Stone or Masonry Foundations

How to Identify

- Foundation is constructed with unreinforced masonry brick or stone (common until about the early 1920's).
- Continuous foundation has signs of deterioration, diagonal cracking, or obvious settlement.
- Unreinforced masonry foundations can be identified by observing header courses every 5-6 rows.
- Isolated stacked brick or stone column supports.



Isolated stone or brick piers



PHOTO COURTESY OF CALIFORNIA SEISMIC SAFETY COMMISSION

Continuous unreinforced stone or masonry foundation



PHOTO COURTESY OF CALIFORNIA SEISMIC SAFETY COMMISSION



Why it Matters

Homes supported on unreinforced stone or masonry lack continuous steel reinforcement that helps create a stronger, monolithic system that has historically performed much better in past earthquakes. Older foundations often have deteriorated masonry or mortar that makes them weaker. Continuous foundations that have signs of deterioration, diagonal cracking, or obvious settlement may have already been compromised.

Earthquake damage associated with these foundation systems can vary from minor to extreme depending upon the original materials used, method of construction, their current condition, and the stability of the soil they bear on.

Common Retrofit Solutions

Foundations that are not continuous should be replaced. A design professional is recommended to assess and design the required retrofits. Where a design professional recommends retrofitting, work could include partial to complete foundation replacement or strengthening in place. Where a design professional recommends new foundations or partial replacements, the work should only be attempted by an experienced contractor.

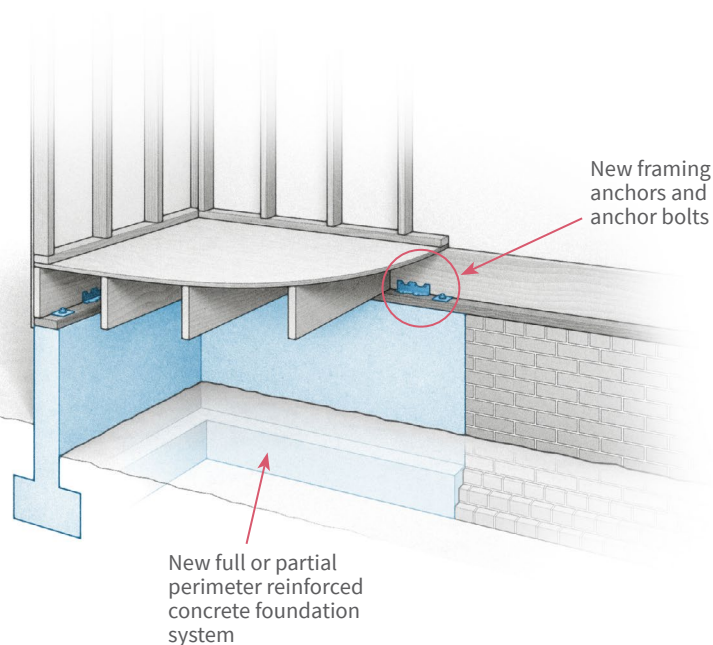


PHOTO COURTESY OF MICHAEL MAHONEY



Photo of damage to unreinforced masonry building in South Napa Earthquake.

COURTESY OF BETSY MATHIESON, AVAILABLE AT WWW.EERI.ORG, LAST ACCESSED 7/7/19





LARGE PROJECT

- Contractor may be required
- Design professional may be required
- Prescriptive plans available

Retrofit Masonry Chimneys

How to Identify

- Home has a brick or stone masonry chimney.
- Chimneys are most often located at the dwelling exterior wall but can also be at the interior.

Why it Matters

- Masonry (brick or stone) chimneys are frequently damaged and can collapse in moderate to large earthquakes, posing a risk of injury if they fall into commonly used areas, either inside or outside the home.
- Older masonry chimneys are particularly vulnerable.
- Even chimneys constructed recently in accordance with earthquake bracing requirements may be vulnerable to damage, but are considered to pose a lesser safety hazard.

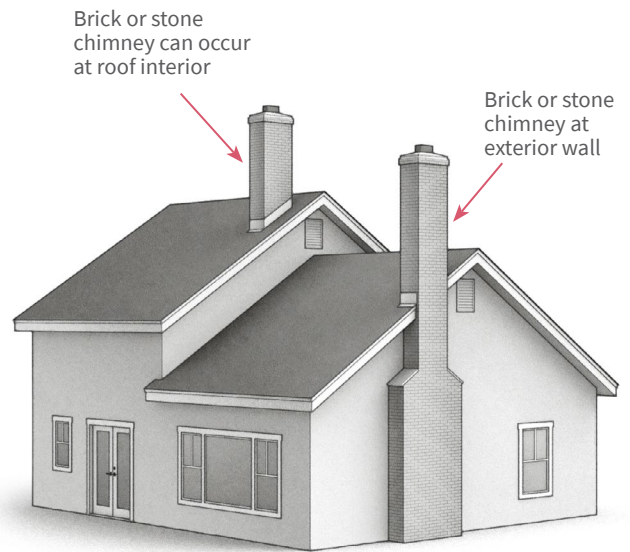


PHOTO COURTESY OF RONALD GALLAGHER



PHOTO COURTESY OF RONALD GALLAGHER



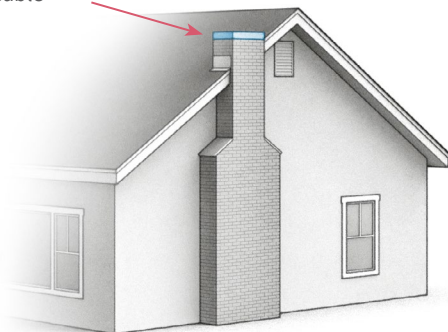
PHOTO COURTESY OF NATIONAL GEOPHYSICAL DATA CENTER, NATURAL HAZARDS SLIDE SETS (2009)



Common Retrofit Solutions

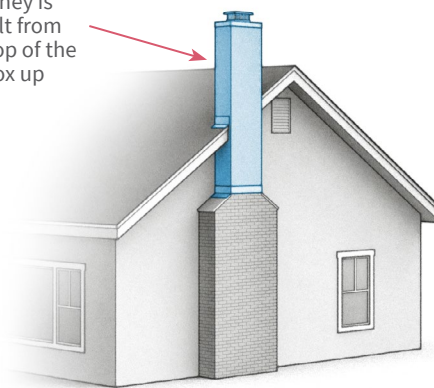
- Short of full chimney reconstruction, it is generally considered infeasible to retrofit chimneys to meet modern earthquake bracing requirements.
- Chimneys are best retrofitted with partial or complete removal of the masonry. Chimneys can then be reconstructed with metal flues or fireplace inserts and light-frame construction. Retrofit measures providing a range of hazard reduction include:
 - » Capping the chimney at the roof level making the fireplace no longer usable (see below left),
 - » Rebuilding the chimney from the top of the firebox up, either maintaining the use of the existing masonry firebox, or installing a fireplace insert (see below right), or
 - » Fully rebuilding the firebox and chimney in wood or steel stud construction (see below center). Complete rebuilding of the chimney using masonry must be in full compliance with the latest *International Residential Code*.
- Where retrofit is not feasible, risk of injury can be reduced by limiting use of areas immediately surrounding the chimney, both inside and outside of the home.
- These strengthening measures will likely require the services of an experienced contractor. FEMA P-1100, *Vulnerability-Based Seismic Assessment and Retrofit of One- and Two-Family Dwellings*, Volume 1 provides a description of the problem and retrofit solution. Volume 2C presents a prescriptive plan set for this type of retrofit. Prescriptive plan sets are applicable to some homes and will save the additional cost of a design professional. Where the home falls outside of the scope of these plan sets, the services of a registered design professional experienced in residential construction will be required. It is important to note that although previous guidance suggested strapping of the chimney as a retrofit technique, chimney failures occurred due to variations in the solution. Therefore, this type of retrofit is no longer recommended.

Chimney is capped at roof level, fireplace is no longer usable



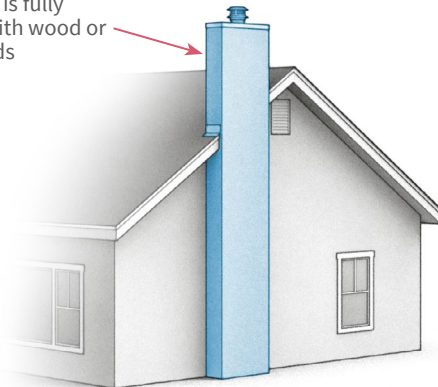
CAPPED CHIMNEY

Chimney is rebuilt from the top of the firebox up



PARTIALLY REBUILT CHIMNEY

Chimney is fully rebuilt with wood or steel studs



FULLY REBUILT CHIMNEY

Survive



Overview

Understanding what you need to do in the event of an earthquake is paramount to your safety and your family's safety. Unfortunately, earthquakes do not provide us with sufficient warning like other disasters (hurricanes, wild fires, floods). This chapter provides best practice recommendations on how to protect yourself and your family during and immediately after an earthquake event.

What to do During an Earthquake

Federal, state, and local emergency management experts and other official preparedness organizations agree that the best way to reduce injury and death during an earthquake is to “Drop, Cover, and Hold On.” This simple three-step reaction can greatly increase your chances of surviving the earthquake. When the shaking starts, you will have very little time to protect yourself, and it will be difficult to move. You must decide what to do quickly. This section presents different ways to protect yourself depending on where you are when the shaking starts.

In most circumstances, the best way to survive an earthquake is to:

- **DROP** where you are onto your hands and knees. This position protects you from being knocked down and also allows you to stay low and crawl to shelter if nearby.
- **COVER** your head and neck with one arm and hand. If a sturdy table or desk is nearby, crawl underneath it for shelter. If no shelter, crawl next to an interior wall (away from windows, tall furniture, or other items that might break or fall on you). Stay on your knees and bend over to protect vital organs.
- **HOLD ON** until the shaking has stopped. If under shelter, hold on to it with one hand and be ready to move with your shelter if it moves during shaking. Otherwise, hold on to your head and neck with both arms and hands.
- **DO NOT RUN OUTSIDE!** Do not panic. Stay where you are until the shaking has stopped. If there is damage, be very careful how you exit the building.
- **DISABLED OR LIMITED MOBILITY PERSONS.** Persons using wheelchairs: lock your wheels, bend forward, and *Cover* your head with your arms and *Hold On* to your head and neck with both hands until the shaking has stopped. *Do Not Go Outside* until the shaking has stopped and then make a thoughtful assessment of the safest exit route out of the building. The best course of action for those with limited mobility may be to stay in place and call 911 for assistance.

INDOORS

- **In your home.** Move away from windows, *Drop* onto your hands and knees. *Cover* your head with your arms and *Hold On* to your neck. If near a table or desk, crawl under it and *Hold On* to your shelter with one hand and the other hand covering your head and neck. *Do Not Go Outside* until the shaking has stopped.

Drop, Cover, and Hold On!

When the building begins to shake, the immediate actions to take for your safety are:

For earthquake protective actions for people with mobility disabilities, see [page 57](#).

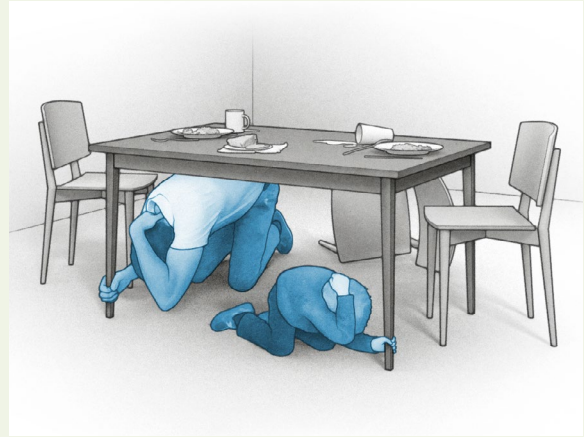


GRAPHIC COURTESY OF EARTHQUAKE COUNTRY ALLIANCE AND SOUTHERN CALIFORNIA EARTHQUAKE CENTER

[HTTPS://WWW.SHAKEOUT.ORG](https://www.shakeout.org)

- **Indoors, no table or desk.** *Drop* onto your hands and knees, *Cover* your head with your arms, and *Hold On* to your neck with both hands. For more protection, crawl next to an interior wall or low-lying furniture.
- **If seated and unable to drop to the floor.** Bend forward, *Cover* your head with your arms and *Hold On* to your neck with both hands.
- **In bed.** Do not get out of bed. Lie face down to protect vital organs and *Cover* your head and neck with a pillow keeping your arms as close to your head as possible, while you *Hold On* to your head and neck with both hands until the shaking has stopped.
- **In a classroom.** *Drop, Cover, and Hold On.* The desk provides the safest shelter in a classroom environment. Other education environments including laboratories may require added precautions to consider. *Do Not Go Outside.* Wait until the shaking has stopped before carefully exiting the building. Follow the instructions and directions from teachers and administrators.
- **Utilities.** Be aware that building utilities may be disabled (loss of electrical power) and sprinkler systems or fire alarms may be activated by the shaking.
- **Aftershocks.** Be prepared to *Drop, Cover, and Hold On* when aftershocks occur.

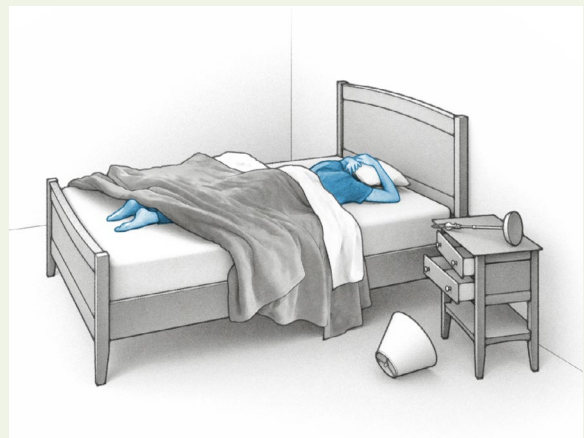
Drop, Cover, and Hold On examples in your home



Under a dining room table.



In the open or those with limited mobility.



In the bedroom.

Outdoors



Move away from the exterior walls of your home to an open area to prevent building elements, such as glass, chimneys, stone or masonry veneer siding, and parapets from falling on you.

OUTDOORS

- **Outside your home.** Move away from the exterior of buildings as things may drop from the building. The center of the street, provided traffic has stopped, offers a safer location. Moving away from the building exterior is particularly important due to the potential for falling debris – glass shards, masonry or brick chimneys, and brick or stone exterior veneer. In older construction with unreinforced masonry or brick, move away from the exterior walls as brick parapets and the upper sections of masonry walls or cladding are extremely vulnerable to collapse.

- **Open areas.** Quickly move away from power lines, trees, vehicles, and other hazards that could become damaged and fall, then *Drop, Cover, and Hold On* to protect yourself from any debris that may be thrown towards you.
- **In a moving vehicle.** Pull over to the side of the road, stop, and set the parking brake. Avoid overpasses, powerlines, trees, large sign structures and other hazards overhead. Remain in your car until the shaking has stopped, then proceed carefully by avoiding bridges and overpasses, fallen debris, cracked or shifted pavement, and emergency vehicles.
- **Aftershocks.** Be prepared to *Drop, Cover, and Hold On* when aftershocks occur.

What to do Once the Shaking has Stopped

- **Wait.** Once the shaking has stopped, remain calm and wait before getting up to look around you for debris or other dangers.
- **Remain in-place if no immediate indication of building damage is observed.** You are safer remaining in the building if it is not damaged. If there is no immediate indication of damage, stay in the building and monitor local news reports for emergency information and instructions. Immediate indications of damage include walls noticeably leaning or significantly racked, doors jammed so they are not operational or difficult to open, and floors, ceilings, or roofs with dropped portions. The *Recover and Repair* section provides a follow-up safety check with more detail for your home.
- **Evacuate if the building has an immediate indication of damage.** Do not panic and remain calm. If there is damage to the building and a safe way out through the

debris, cautiously exit the building and go to an open space outside. Do not re-enter the building until it has been evaluated and determined safe for re-entry.

Do not use elevators. If your home has an elevator, it may be damaged or disabled. Stairs are the safest way to exit.

- **If your home is near a shore or below a dam.**

Drop, Cover, and Hold On until the shaking has stopped. Then move quickly and safely towards higher ground or as instructed to designated evacuation routes or areas. Large earthquakes may cause dams to break and flood downstream to low-lying areas possibly for miles. Near shorelines such as the Pacific Coast, the earthquake may trigger a tsunami.

- **If trapped in your home or a damaged building.**

Do not panic and remain calm. Do not move about if it creates additional dust. Avoid shouting as this will cause more inhalation of dangerous amounts of dust. Cover your mouth with a handkerchief or with clothing. Use your cell phone to text or call for help. Notify them where you are and your condition. Tap on a metal pipe or a wall, or use a whistle if available so rescuers can locate you.

- **Check for injuries.**

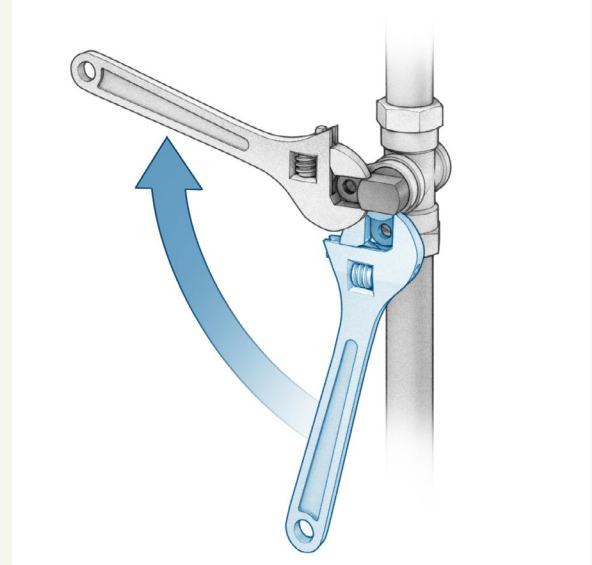
- » Help the injured and provide assistance if you have proper training.
- » Do not move seriously injured persons unless they are in danger of further injury.
- » If a person is bleeding, put direct pressure on the wound.

911

911 should only be used in life-threatening distress. Social media should not be used to report life-threatening distress due to potentially limited resources available to monitor numerous social media platforms during a large-scale rescue effort.

Gas Shut Off

Know where your gas shut off is located and how to turn it off. Turn valve clockwise from vertical (aligned with piping) to horizontal (perpendicular to piping) to shut off gas.



- » Keep injured persons warm to prevent shock.
- » If help beyond first aid is needed, call 911 or use text messaging for help.

- **Check for hazards to prevent additional damage.**

- » Be prepared for aftershocks. Stay away from buildings or areas that look unsafe and could fall.
- » Put out small fires if a fire extinguisher is available. Evacuate if a large fire is present. Notify the fire department and alert neighbors if you are unable to put out the fire as it could quickly build and spread to adjacent properties.
- » Shut off the gas supply if you smell or hear a gas leak. A rapidly spinning gas meter is also a direct indication of a gas leak. Note that only the gas company can turn the gas back on, so shut off the gas only if necessary. See the *Respond* section for more details on shutting off gas.

What NOT to Do

Do not eat or drink anything from open containers near shattered glass.

Do not use your telephone, except for a medical or fire emergency. You could tie up lines needed for emergency response.

Do not turn the gas on again if you turned it off; let the gas company inspect for leaks and turn the gas back on.

Do not use matches, lighters, candles, camp stoves or barbecues, electrical equipment, including telephones, or appliances until you are sure there are no gas leaks. They may create sparks that could ignite leaking gas and cause an explosion and fire.

- » If you suspect electrical wiring damage or observe sparking, turn off power to your home at the main breaker panel by switching the main breaker to off.
- » Clean or contain spills of medicines, drugs, or other potentially harmful materials such as bleach, lye, and gasoline or other hazardous materials if equipped to do so.
- » Unplug appliances and electronics. When power is restored, damaged appliances and electronics could start a fire.
- » Approach chimneys, particularly masonry, very cautiously to inspect for damage. The damage could have weakened the chimney which could topple during aftershocks. Do not use the fireplace if the chimney is damaged or you see debris inside the fireplace from material that has dislodged and fallen from inside. Using the fireplace could start a fire or release poisonous gases into your home. Do not use candles or matches. If there is a gas leak, a fire or explosion could occur.

- **Communicate.**

- » Execute your Post-Event Communication and Reunification Plan (see [page 20](#)) to let your Primary Communication Safety Contact know that you are safe. Let them know if you have any immediate needs so that they can begin to coordinate with

emergency responders. Stay off the phone as the systems can be overloaded. Use text messaging rather than cellular calls.

- » Register on the Red Cross [Safe and Well](https://safeandwell.communityos.org/cms/index.php) website so people will know you are okay: <https://safeandwell.communityos.org/cms/index.php>.

- » **Do not** expect firefighters, police, or paramedics to help you right away. They may not be immediately available.

- **Access your emergency supplies.**

- » Retrieve your emergency supplies.
- » Review and assess how long your stock on hand will last.
- » Conserve supplies if necessary.

- **Stay informed.**

- » Use any available means (phone, emergency, or weather radio) to assess the regional conditions to understand the location of help, emergency shelters near you, and blocked roads and bridges.

- **Help those in your community.**

- » If able, walk your neighborhood and provide assistance to neighbors as necessary.

- **Begin the recovery process.**

- » Refer to the [Respond](#) and [Recover and Repair](#) sections for additional guidance on the days and weeks following the earthquake event.



Earthquake Protective Actions for People with Mobility Disabilities

**IF
POSSIBLE**



**USING
CANE**



**USING
WALKER**



**USING
WHEELCHAIR**



[EarthquakeCountry.org/step5](https://www.earthquakecountry.org/step5)

GRAPHIC COURTESY OF EARTHQUAKE COUNTRY ALLIANCE AND SOUTHERN CALIFORNIA EARTHQUAKE CENTER
[HTTPS://WWW.EARTHQUAKECOUNTRY.ORG/DISABILITY/](https://www.earthquakecountry.org/disability/)

Respond



Overview

Once the emergency situations discussed in the *Survive* section are addressed, residents can turn their attention to returning to their neighborhoods and homes, and resuming their usual daily activities once it is deemed safe to do so. This chapter addresses earthquake safety at home in the first days after a damaging earthquake. Included is a *Home Safety Checklist* and a *Checklist Summary* that should be used in the recovery phases following an earthquake.

Re-Entering Your Neighborhood

If voluntary or mandatory evacuations were ordered for your neighborhood, it is important that you not return until local authorities (mayor, police, fire, and other emergency-response personnel) have lifted the evacuation order. Reasons for evacuation vary and can include significantly damaged buildings, downed power lines, damage to utility systems, high fire hazard, or even tsunami flood hazard. When the hazard has been addressed, local authorities will give notification that residents can re-enter the area.

Even if there have been no evacuations of the neighborhood, residents are encouraged to be on the lookout for potential hazards, and should notify local authorities (police, fire, utility companies) if hazards are found.

Home Safety Check (by Owner or Resident)

Whether you were at home or away during the earthquake, it is important to check home safety before continuing to occupy the home. This section provides a [Home Safety Checklist](#) intended to be used by the owner or resident. If you are conducting the home safety check in daylight, an exterior check should be performed first ([pages 62-71](#)). If you are conducting the home safety check at night, conduct an interior check first ([pages 66-73](#)), followed by an exterior check when it is safe to do so. When walking around inside or outside your home following an earthquake, sturdy closed-toe shoes and a flashlight are recommended in order to avoid injury from broken glass and debris. Refer to the [Survive](#) section on [page 52](#) for actions to take when you are inside or outside of your home during and after an earthquake.

While using the [Checklist](#), document damage to your home or property. Photos or video taken with your phone are a good way to document damage. Contact your building department or insurance agent as necessary.

Check Home Safety

Whether you were at home or away during the earthquake, it is important to check home safety before continuing to occupy your home.

The first step is a home safety check performed by the owner or resident using the [Home Safety Checklist](#).

If indications of concern are found, the second step is a home safety evaluation performed by a professional, as discussed in [Home Safety Evaluation](#) on [page 74](#).

Walk around all accessible portions of the home to identify initial indications of damage and label these with either *OK* or *Needs Attention* on the following checklist depending on your best judgment of the damage conditions. After checklist items needing attention have been resolved, update the home safety checklist. The one-page [Home Safety Checklist Summary](#) on [page 61](#) can be used to summarize conditions that you have identified in and around your home using the detailed [Checklist](#).

The checklist describes conditions commonly seen following an earthquake and, if needed, recommended next steps. Damaged items or areas beyond those in the checklist could be found, and follow up measures should be taken for any condition thought to be of concern. Signs of significant damage to homes are generally readily obvious, but if unsure, it is always better to err on the side of caution. If strong aftershocks occur after you have completed the home safety check, consider repeating the check. Following the initial walk through, this checklist can be used to mark and record repaired damage for your home's recovery.

Where damage has occurred to the roof or exterior walls, steps should be taken to help prevent further damage. In some cases, use of tarps over the roof and exterior walls will be necessary to protect the interior of your home from weather damage. Caution is required when climbing on a roof or other portion of the home that is believed to be damaged. When in doubt regarding safety, do not climb on potentially damaged portions of your home.

Home Safety Checklist Summary

Potentially Damaged Area or Condition	Page	OK	Needs Attention	Resolved	Notes
Gas	62				
Propane or Other Fuel Tanks	62				
Masonry Chimneys	63				
Masonry Walls and Parapets	64				
Solar Panels	64				
Manufactured (Mobile) Homes	65				
Electrical	66				
Water Leaks	67				
Masonry Veneer Detachment	68				
Racked and Leaning Walls, Gaps, Stuck Doors and Windows	69				
Sewer Lines	70				
Glass	70				
Water Heaters	71				
Small Appliances	71				
Furniture and Home Contents	72				
Wall Damage	73				

Home Safety Checklist - After an Earthquake

Gas

OK

Needs Attention

Resolved

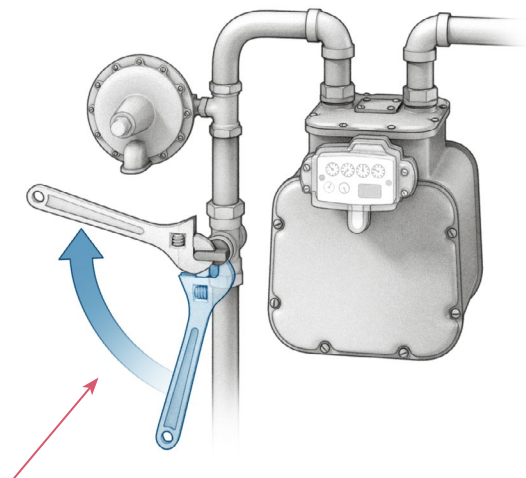
Check for the smell of gas (should have a noticeable odor) that might indicate a broken gas line. Check at gas meter and in vicinity of gas-powered appliances (such as water heaters, furnaces, stoves, and gas fireplaces). If your home has a crawlspace, check for gas odor at the crawlspace access openings and vents.

Note: If the crawlspace walls have noticeably slid relative to the foundation (about an inch or more of sliding) or are visibly leaning (top of wall has moved about two inches or more relative to bottom of wall), immediately turn off gas at the meter and request a home safety evaluation (See [Home Safety Evaluation on page 74](#)). Do not reoccupy the home until the home safety evaluation has occurred.

If Occurs:

Turn off your gas at the meter. If gas smell appears to be from beyond your property, notify the local authorities (call 911) first and then notify the gas company.

TURN VALVE CLOCKWISE TO SHUT OFF GAS



Turn valve clockwise from vertical (aligned with piping) to horizontal (perpendicular to piping) to shut off gas.

Propane or Other Fuel Tanks

OK

Needs Attention

Resolved

Check above-ground tanks for shifting, falling off their supports, damaged anchorages, or other visible damage. Check for visible damage to fuel piping and controls.

If Occurs:

Turn off fuel flow from the tank to the home. Barricade the area around the tank and contact qualified professionals to make needed repairs.

Home Safety Checklist - After an Earthquake

Masonry Chimneys

OK

Needs Attention

Resolved

Check for masonry chimneys that have cracked, shifted, or dislodged. Common locations for damage are at the roof line and where the chimney narrows, but damage at other locations can occur.

If Occurs:

Do not occupy areas in immediate vicinity of the damaged chimney, either inside or outside of the home. Request a home safety evaluation (see [page 74](#)). Note that chimneys that have entirely fallen all the way to the ground will generally no longer pose a safety hazard. A check should be made that there are no remaining loose bricks that could still fall. Do not push on a chimney that you suspect is damaged, as pushing could cause collapse.

Regardless of whether or not there is visible damage, do not use the fireplace until a chimney inspector has determined that it is safe to use.

Note that vents from some appliances, such as furnaces and water heaters, are sometimes routed through the chimney. Where damage to the chimney is suspected, do not operate appliances that vent through the chimney until the vent is determined to be functional.

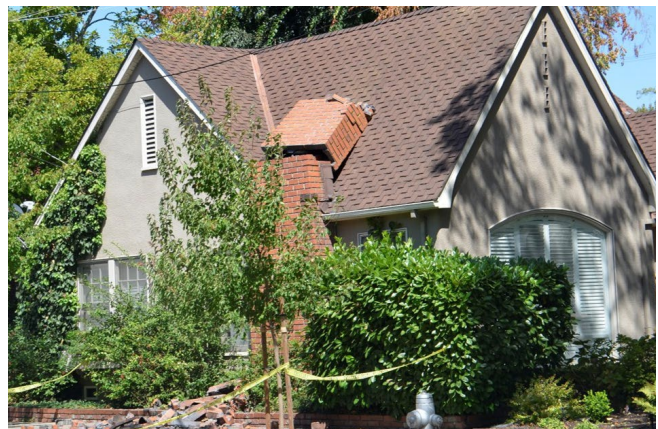
Damaged Chimneys

Regardless of whether or not there is visible damage, DO NOT use the fireplace until a chimney inspector has determined that it is safe to use.



Shifted chimney.

PHOTO COURTESY OF KELLY COBEEN



Earthquake damaged chimney.

PHOTO COURTESY OF JANIELE MAFFEI

Home Safety Checklist - After an Earthquake

Masonry Walls and Parapets

OK

Needs Attention

Resolved

Where the home has brick or stone masonry exterior walls, check on the ground around the entire perimeter of the home for fallen bricks or stones, check the wall (particularly near the roof level) for shifted or dislodged bricks or stones, wall leaning, or other indications that the wall has pulled away from the building.

If Occurs:

Do not occupy areas in immediate vicinity of the masonry wall. Block or barricade the area if possible. Request a home safety evaluation (see [page 74](#)).

Solar Panels

OK

Needs Attention

Resolved

Check for rooftop solar panels that have been damaged or shifted, creating a possible falling or fire hazard.

If Occurs:

If solar units or wiring appear damaged or units have moved significantly, switch off solar electricity feed to the home when possible. Contact qualified professional to make needed repairs. If necessary, take steps to stabilize inadequately supported units or barricade area where they could fall.



Masonry parapet separation.

PHOTOS OF DAMAGE TO URM BUILDING FROM 2016 OKLAHOMA EARTHQUAKE, COURTESY OF EZRA JAMPOLE, AVAILABLE AT WWW.EERI.ORG, LAST ACCESSED 11/13/19

Home Safety Checklist - After an Earthquake

Manufactured (Mobile) Homes

OK

Needs Attention

Resolved

In addition to items previously discussed for all home types, check to see if the home has fallen off one or more support piers. This may be obvious from a distance if the home has clearly dropped down towards the ground. If there is no clear indication of the home dropping, open up the skirting and look for rotated or toppled support piers. Where the home has shifted, check utility hookups for damage, especially those for natural gas. Check also for damage to attached porches, carports, and other miscellaneous structures.

If Occurs:

Shut off utilities if hookups are damaged. Request a home safety evaluation (see [page 74](#)). The home will need to be reinstalled and utility hookups repaired, if required.



Manufactured home that has fallen off of support piers.

PHOTO COURTESY OF KELLY COBEEN



Manufactured home rotated and fallen support piers.

PHOTOS COURTESY OF KELLY COBEEN

Home Safety Checklist - After an Earthquake

Electrical

OK

Needs Attention

Resolved

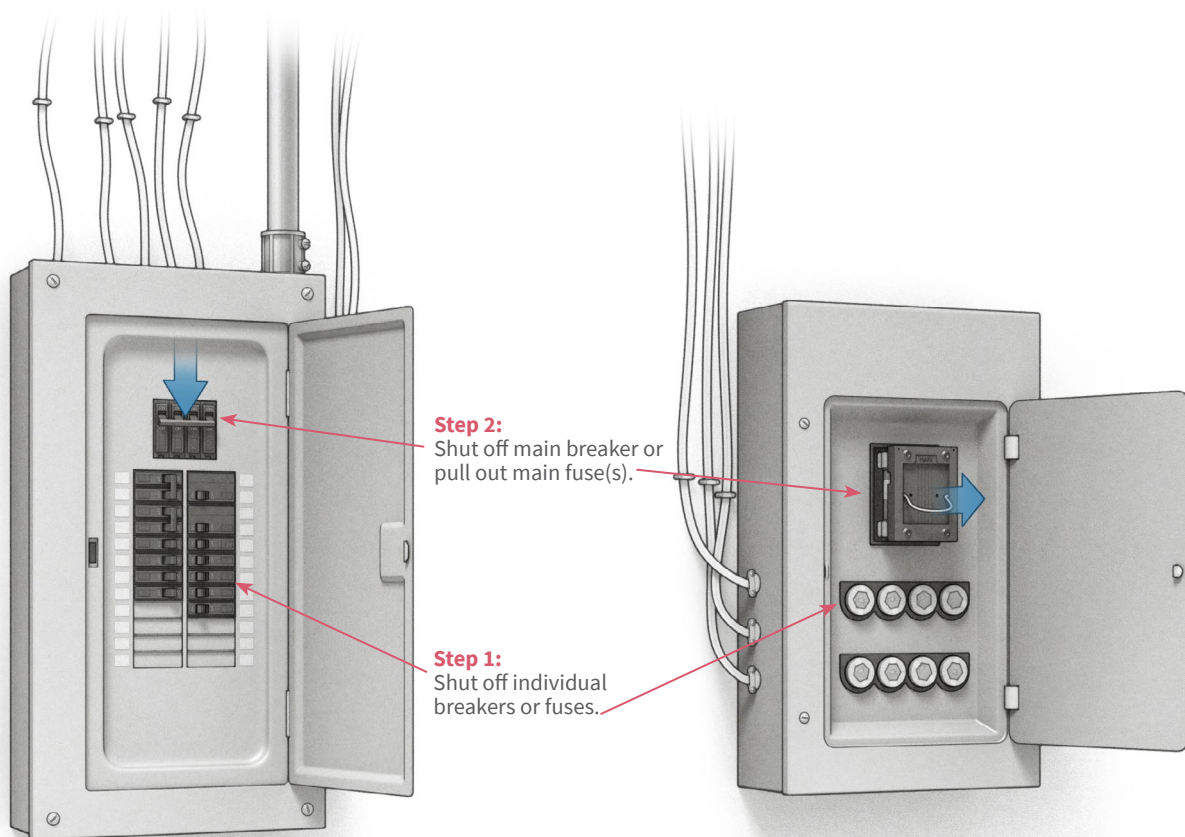
Check for damaged electrical lines. Start with the exterior line hookup to your home. If electrical lines are underground, check the exterior main electrical panel. Look for signs of damage or dislodgement and for circuits that may have tripped.

If Occurs:

Turn off electrical power to the home at the main electrical panel. When possible, turn off each breaker switch or fuse (**Step 1**) before turning off the main incoming power breakers (**Step 2**). This helps avoid causing an electrical surge while turning power off. If the situation is judged to be an emergency, proceed immediately to **Step 2**. Contact electrical utility for damage to hookup and incoming lines. Contact a qualified professional regarding electrical damage at the interior of the home. When unsure about location of potential damage, contact the electrical utility.

TURNING OFF ELECTRICITY AT THE MAIN ELECTRICAL PANEL OR FUSE BOX

When time permits, turn off individual breakers or fuses first (**Step 1**) and then main breaker or fuse (**Step 2**). When there is an immediate hazard, go directly to **Step 2**.



Home Safety Checklist - After an Earthquake

Water Leaks

OK

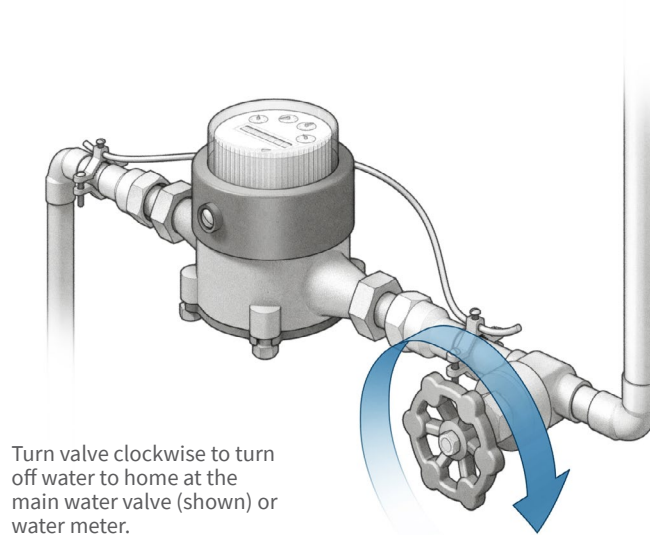
Needs Attention

Resolved

Check for liquid dripping or puddling that could be a sign of damaged water pipes. Look in vicinity of kitchen and bathroom fixtures, and other appliances using water. If water pipes enter the house through a crawlspace, check in the crawlspace.

If Occurs:

Water can be turned off at a particular fixture, or if necessary, for the entire home. The valve to turn off water to the entire home may be outside of your home in warm weather climates. In other places, it may be where the water pipe enters the home. A second valve is often found in the immediate vicinity of the water meter.



Turn valve clockwise to turn off water to home at the main water valve (shown) or water meter.

Masonry Veneer Detachment

OK

Needs Attention

Resolved

Check interior and exterior brick or stone wall finishes for signs of shifting, detachment from wall, or falling. One common place to find veneer is surrounding a fireplace. Stone and brick veneer can separate from the wall supporting it. If you push (gently) on the brick or stone and it visibly moves, there is potentially damage and the possibility of the veneer falling down.

If Occurs:

Request a home safety evaluation (see [page 74](#)). Block the surrounding floor or ground areas so no one will be injured if the veneer falls.



Brick masonry veneer fallen off of home exterior.

PHOTO COURTESY OF RONALD GALLAGHER

Racked and Leaning Walls, Gaps, Stuck Doors and Windows

OK

Needs Attention

Resolved

Check for walls that are visibly racked or leaning (see illustration below) or doors and windows that are stuck. Check for portions of the home that appear to have moved, fallen down, collapsed, or where gaps have opened up between portions of the home.

If Occurs:

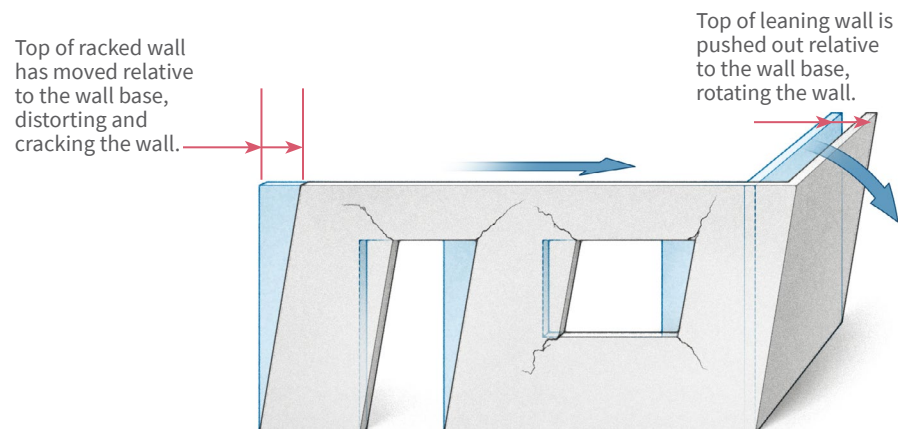
Request a home safety evaluation (see [page 74](#)). Where any of the following are found, do not occupy the home until the home safety evaluation has occurred:

- Walls are significantly racked or leaning (top of the wall has moved approximately one or more inches relative to the bottom of the wall), or
- Gaps between portions of the home are approximately an inch or more, or
- Portions of the home appear to be falling down, or
- Exit doors are stuck so that it may be difficult to exit in an emergency.



Examples of significant earthquake damage—portions of homes that appear to be leaning or have fallen down.

PHOTO COURTESY OF RONALD GALLAGHER



Wall racking (deformed in its plane) and leaning (out-of-plane) due to earthquake loading.

Home Safety Checklist - After an Earthquake

Sewer Lines

OK

Needs Attention

Resolved

Check for damage to sewer lines. This would most likely be seen in the crawlspace or basement (where exists), at a clean-out immediately outside the home, or by smell. Significant leakage of damaged sewer lines can lead to health hazards.

If Occurs:

Refrain from putting kitchen, toilet, shower, and bath waste water into the drains and sewer system until sewer damage can be repaired.

Glass

OK

Needs Attention

Resolved

Check for broken glass on the ground or still in place in door and window frames.

If Occurs:

Clean up already fallen glass, cover with plywood or similar panel or barricade (with furniture or similar) around area with glass remaining in window or door frame until it can be safely removed and replaced. Care should be taken to avoid injury while removing broken glass, and particularly glass that might still be hanging in the window or door opening but could fall during clean up. When glass panels have cracked but otherwise remain in place, they are often best left in place and covered with plywood or cardboard until replacement glass is available for installation.

Home Safety Checklist - After an Earthquake

Water Heaters

OK

Needs Attention

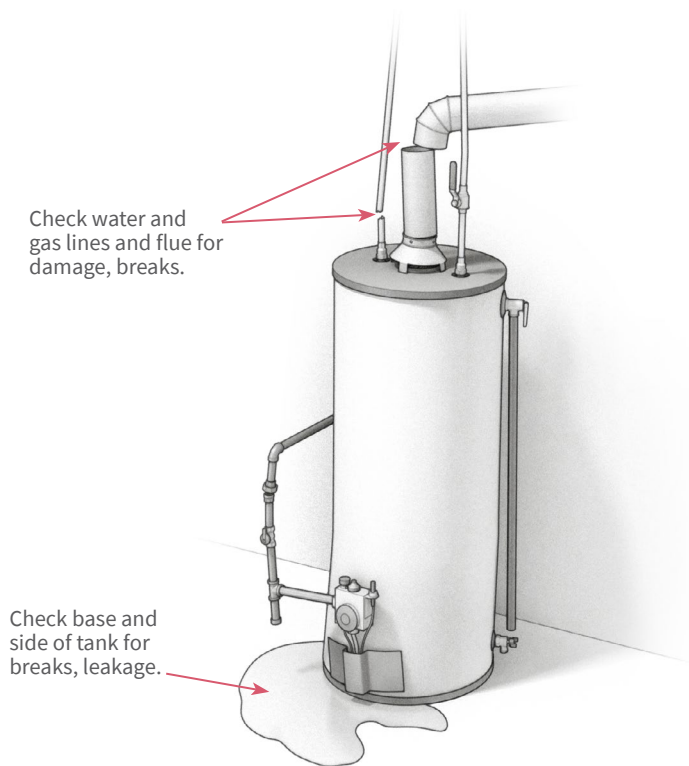
Resolved

Check for damage to the water heater, including broken gas and water supply lines, breaks or anchor failures at existing straps, fractures to the tank, water leakage, and dislodging of vent pipes.

If Occurs:

Shut off gas and water lines immediately. If the water heater is electric, shut off power. If the tank is fractured and leaking, steps should be taken to drain water and dry wet areas as soon as possible because water retained inside of wall and floor cavities can lead to mold damage. Drained water can be saved for later use if it is clean and practical to save. Information on how to strap your water heater can be found on [page 28](#).

SAFETY CHECK OF WATER HEATER



Small Appliances

OK

Needs Attention

Resolved

Check small appliances for damage due to power surges during the earthquake. Look for scorch marks around appliances or electrical outlets. Look and smell for signs of smoldering or excessive heat. If outside your home, you might be able to look in through a window for any initial signs of danger before entering your home.

If Occurs:

Unplug all small appliances. If there are signs of damage, dispose of or repair appliances before using. If there are no signs of damage, plug them back in when you have time to observe whether each is functioning normally.

Furniture and Home Contents

OK

Needs Attention

Resolved

Check for hazards from leaning or toppled furniture, food service items, and mixed cleaning chemicals.

If Occurs:

Stabilize furniture. Clean up broken glass and chemicals using proper tools, ventilation, and protective measures. Mixed cleaning products can be dangerous to touch and can create fumes that are dangerous to breathe.

Home Safety Checklist - After an Earthquake

Wall Damage

OK

Needs Attention

Resolved

Check interior and exterior wall finish materials, such as stucco, gypsum board, and plaster, for cracks greater than 1/8-inch wide and several feet long. Check for bulging or buckling finish material, or detachment of finish material from the walls (finish material moves when pushed on or gaps between framing and finish material are detectable).

If Occurs:

Request a home safety evaluation (see [page 74](#)). Where none of the exterior doors are operable, do not occupy home until doors are made operable and the home safety evaluation has occurred. Where one or more doors remain operable, the home can be occupied, but damage and required repairs should be evaluated by an insurance professional or design professional (architect or engineer). This finish material damage is an indicator that repair of damage may require more than just patching and painting.



Significant cracking of wall finish materials.
PHOTOS OF DAMAGE TO WALL FINISH MATERIALS FROM
ANCHORAGE EARTHQUAKE. COURTESY OF JANISE RODGERS,
AVAILABLE AT WWW.EERI.ORG, LAST ACCESSED 8/3/19

Check Neighborhood Safety

Check on your neighbors, especially the elderly and disabled. If assistance is needed, draw on neighbors to take on specific assigned tasks.

Getting Supplies and Assistance

Check food and water supplies that you have on hand. Identify if you have any urgent food or water needs. If electricity is out, use food in your refrigerator and freezer first because it will spoil first. If water is not available, use ice from the freezer and water from the water heater.

Do not use water from a pool or spa. Do not eat food that might have been near breaking glass, as glass shards could be in the food. Do not light fires or candles, use barbeques, or use other electronic equipment until it has been determined that there are no gas leaks present. Otherwise, a spark could start a fire or explosion.

Monitor local radio or television reports for information on emergency assistance, including supplies and services. Local fire stations and community centers will often have emergency supplies available or know where emergency assistance can be obtained.

Home Safety Evaluation (by building inspector, engineer, or architect)

If significant damage to your home is suspected, a post-earthquake safety evaluation should be made. Some jurisdictions may have a program in place and will be able to send a qualified evaluator (building inspector or qualified volunteer engineer or architect) to determine whether your home is safe to occupy. Otherwise, the homeowner may need to hire a professional to perform a safety evaluation. It can be difficult, however, to find a qualified engineer or architect immediately following an earthquake. If requested by the owner or resident or if determined necessary by the local building department,

Monitor local radio or television reports for information on emergency assistance, including supplies and services.



qualified evaluators will come to your home to perform a safety evaluation. The evaluator will first knock on the door to show photo identification and necessary paperwork. Next, the evaluator will typically make a complete check of the home from the exterior first, and then if deemed necessary and permitted by the resident, conduct an interior check. If there is damage that is of concern to you, you can ask the evaluator to look at the damage with you. Post-earthquake safety evaluations can take as little as fifteen minutes but may take longer, depending on the size of the home and the amount of potential damage that is of concern. The evaluator will only look for indications of damage due to the earthquake that would make the home unsafe to occupy or would require limits on occupancy in portions of the home. The condition of the home prior to the earthquake should not factor into the evaluation. An evaluation to determine the need for and extent of repairs is done by others, as discussed in the [Recover and Repair](#) section.

At the conclusion of the safety evaluation, the evaluator will fill out a form for the building department and fill out a placard that will be posted at the entrances to your home. A green placard will indicate that there are no limits on the occupancy or use of the home. A yellow placard will indicate limitations on use. This may specify a limited period of time for residents to remove their belongings, beyond which the home may not be occupied. A yellow placard may, alternately, indicate a portion of the home that is not safe to occupy (such as in the immediate vicinity of a damaged chimney), while the rest of the home can be occupied. A red placard indicates that the entire home is thought to be a potential hazard to life and cannot be entered or occupied until knowledgeable design professionals are able to further evaluate the conditions and determine required stabilization methods to allow retrieval of possessions or required repairs. If a red placard is assigned, you will be asked to leave the building immediately. One placard type (green, yellow, or red) is assigned for the entire building. If the building includes multiple units that are posted, all units may be affected in the same way.

The safety evaluator will explain to persons on site at the time of the evaluation what placard is being posted, the reasons, and the limits on use being imposed. The evaluator is deputized by the building department, who gives them authority to conduct the evaluation and post the placard. Only the building department or their deputized evaluator has the authority to remove placards once posted.

If a green placard is posted, no further action is required. If a yellow or red placard is posted, the owner of the home will need to work with design professionals, contractors, and the building department to implement repair design, permitting, and construction. This is discussed further in the *Recover and Repair* section. The safety evaluator does not have any authority to ask about or make any reports regarding the home or residents, beyond evaluating the earthquake safety of the home.

Safety Evaluation Placards

Where safety evaluation programs are available, the evaluator will post a placard similar to one of the graphics below, indicating whether or not there are limitations on continued use of the home.

INSPECTED
LAWFUL OCCUPANCY PERMITTED

This structure has been inspected (as indicated below) and no apparent structural hazard has been found.

Inspected Exterior Only
 Inspected Exterior and Interior

Report any unsafe condition to local authorities; reinspection may be required.

Inspector Comments: _____

Facility Name and Address: _____

Date: _____
 Time: _____

(Caution: Aftershocks since inspection may increase damage and risk.)

This facility was inspected under emergency conditions for _____
 (Jurisdiction)

Inspector ID / Agency: _____

Do Not Remove, Alter, or Cover this Placard until Authorized by Governing Authority

RESTRICTED USE

Caution: This structure has been inspected and found to be damaged as described below.

Entry, occupancy, and lawful use are restricted as indicated below:

Facility Name and Address: _____

Date: _____
 Time: _____

(Caution: Aftershocks since inspection may increase damage and risk.)

This facility was inspected under emergency conditions for _____
 (Jurisdiction)

Inspector ID / Agency: _____

Do Not Remove, Alter, or Cover this Placard until Authorized by Governing Authority

UNSAFE
DO NOT ENTER OR OCCUPY
(THIS PLACARD IS NOT A DEMOLITION ORDER)

This structure has been inspected, found to be seriously damaged and is unsafe to occupy, as described below.

Do not enter, except as specifically authorized in writing by jurisdiction. Entry may result in death or injury.

Facility Name and Address: _____

Date: _____
 Time: _____

This facility was inspected under emergency conditions for _____
 (Jurisdiction)

Inspector ID / Agency: _____

Do Not Remove, Alter, or Cover this Placard until Authorized by Governing Authority

IMAGES COURTESY OF APPLIED TECHNOLOGY COUNCIL
[HTTPS://ATCOUNCIL.ORG/ATC-20](https://atcouncil.org/atc-20)

Recover and Repair



Overview

This chapter addresses earthquake safety at home in the weeks and months following a damaging earthquake. Restarting utilities and repair of damage are discussed.

Recovery in the First Weeks After an Earthquake

RESTARTING UTILITIES

Once damage to utilities has been repaired, take the following steps to restart utilities. Consider using the checklist in the *Respond* section as you address damage and repair to your home.

- If your gas was shut off, contact the gas company to send an employee to your home to restart your gas and relight pilot lights for appliances. The gas company will need access to your home interior to do this.
- If electricity was shut off, turn the main incoming power back on first, and then individual breakers or fuses. This will help avoid a power surge to your appliances and equipment. Check appliances and electronic equipment for damage, and repair or replace damaged items. Plug appliances back in and run them when you can observe whether each is functioning normally. Unplug if behavior is abnormal.
- If water was shut off due to water company repairs, the water can be turned back on once repairs are made. If a water main was broken, the water may need to be run for a few minutes until the water is clear of dirt and debris. Where water mains have broken, check local news media for any requirement that water be boiled prior to use.
- Do not let any person claiming to be an employee of a utility company into your home unless they have a valid identification card with their photo.

ASSISTANCE

Persons having earthquake insurance should contact their insurance company as soon as they are able. Both homeowners' and renters' insurance policies are available, as discussed in the *Protect* section. Type and level of coverage varies and should be discussed with insurance industry professionals. Persons having

earthquake insurance will want to understand the particulars of their coverage and requirements for documenting damage and expenses.

Whether or not you have earthquake insurance, contact local assistance centers to find out about resources that might be available to help with the cost of extra living expenses and repairs. See the *Paying for Repairs* section on [page 83](#).

GENERAL HEALTH AND WELL-BEING

An earthquake and its aftermath can be both physically and emotionally overwhelming. Talk with your family about how they are feeling. Children and older adults are of special concern in the aftermath of disasters. Contact local volunteer agencies, professionals, or faith-based organizations for counseling. See also *Helping Children Cope with Disaster* (FEMA 478).

NEIGHBORHOOD AND COMMUNITY ORGANIZATIONS

Reach out to neighborhood or community organizations and get involved. Your voice is important in deciding how your community will recover and rebuild in the years to come.

Repair of Earthquake Damage

When earthquake damage occurs to your home, there are a number of important issues to be aware of regarding repair of damage. Discussion of these issues follows.

Repair

Where repair to your home will be required, there are a number of considerations, including building code requirements, working with contractors, architects, and engineers, paying for the repairs, and opportunities to build back better. This section provides important information regarding these considerations.

REGULATIONS REGARDING REPAIR

Any repair that goes beyond typical maintenance activities, such as painting or glass replacement, is regulated by building codes adopted and enforced by the local building department, and a building permit is required.

In order to determine applicable regulations, you will need to know which building department has jurisdiction over your home. If you are within a city, it should be the local city building department. If you are in an unincorporated area, it is likely the county building department. In some instances there can be other state or federal agencies that have jurisdiction. The local city or county building department will be able to tell you whether or not you fall under their jurisdiction, and if not, whom you should contact.

BUILDING CODE REQUIREMENTS (REPAIR OR TRIGGERING OF RETROFIT)

Many cities and counties adopt building and residential codes that regulate construction, additions, alterations, and repairs. Repairs to earthquake damaged homes will be regulated by these adopted codes. In general, these codes will permit repair of the home to the pre-earthquake condition. In some instances, however, if the damage was beyond a certain threshold, work exceeding repair, including retrofitting or strengthening of earthquake-vulnerable portions of the home, could be required at the time of repair. It is important to check with the local building department or an architect or engineer familiar with local codes to determine whether any work beyond repair to the pre-earthquake condition is required. Where additional work is required, the building department should be able to identify specific details of applicable requirements in the local building code or adopted ordinances.

Building department regulations are in place to protect the safety of the residents of the home and the community. Following building department regulations will help to make sure that potential safety hazards are addressed and that the home is not left more vulnerable to damage in future earthquakes.

In areas that do not adopt a building code, it is recommended that a design professional (engineer or architect) be hired to assess damage and design repairs in accordance with the latest available model code provisions.

BUILDING PERMIT REQUIREMENTS

Required repairs will need to be documented in repair plans, which are submitted to the building department along with a building permit application form. The building department then reviews the submitted plans and either approves them or requests modification and resubmittal. Once approved, the permit remains open (active) until work is complete and any required inspections of work by the building department have been successfully completed. At the end of repair work, the permit will need to be appropriately closed out with the building department. The owner will want to keep all records of the permit and the successful closing of the permit for future record. Building permits for

Building Permits

A building permit will need to be obtained for any repair work beyond painting and similar maintenance activities.



homes are generally obtained by the contractor who is performing the work. In most instances, the homeowner is also permitted to serve as contractor and obtain permits for their own home. This is intended to occur when the work is performed by the homeowner or under their direction, and should only occur when the homeowner is knowledgeable enough regarding home construction to judge the adequacy and completeness of the work. This is because responsibility for the adequacy and completeness of the work is transferred to the homeowner who has obtained the permit.

Simpler repair work, such as replacing wall finishes, can often be undertaken with just a sketched plan of the building and description of work required, as might be generated by an insurance adjuster or contractor. More complex repair work will generally require involvement of an architect or engineer, who will develop plans detailing the type and extent of repair work.

BUILDING DEPARTMENT INSPECTIONS

During the course of the repair work, it should be anticipated that an inspector from the building department will make one or more visits to inspect the in-progress or completed work. The number of inspection visits will depend on the type and extent of repair work required. Inspections provide an important quality control step, intended to help protect the safety of the occupants and the interests of the city or county in having safe buildings. If work is not conforming to approved repair plans or some aspect of the building or residential codes, the building department will issue a correction notice, and corrections will have to be made before the work can progress. Scheduling of building department inspections and providing access to the inspector is generally handled by the contractor.

One available guideline for assessment is:

Earthquake Damage Assessment and Repair Guidelines for Residential Wood-Frame Buildings, Volume 1 – General, CEA-EDA-01 (ATC-143).

<https://www.earthquakeauthority.com/>

CONTRACTOR LICENSE REQUIREMENTS

In most areas, contractors hired to make repairs are required to be licensed by the state in which the home is located. Contractor licenses can take months to years to obtain and involve exams and demonstration of applicable work experience. A contractor will need to have already obtained their license prior to offering services. See further discussion in the section, *Working with Contractors*.

Contractors may also be required to have city or county business licenses, permitting them to provide services within the city or county. These can often be obtained within days, but should be obtained prior to start of work.

ENGINEER AND ARCHITECT LICENSE REQUIREMENTS

Engineers and architects hired to make assessments and develop repair or retrofit plans are similarly required to be licensed (or registered) by the state in which the home is located. See further discussion in *Working with Design Professionals* on page 83. These licenses often take years to obtain, and should be in place prior to offering services. Engineers and architects may similarly be required to have city or county business licenses, permitting them to provide services within the city or county.

DEMAND SURGE

A surge of demand for contractors, engineers, and architects following an earthquake or similar event is extremely common. This should not be a reason to work with individuals that are unqualified or businesses that are not properly licensed and have not been properly vetted. Demand surge makes follow through on verification of qualifications even more important. Always be sure to check that they are licensed, insured, and bonded, ensure appropriate references, and never pay for work that has not been completed, with the exception of some contractors that may require a small initial payment to secure materials and resources for

the project (see *Paying Contractors* on page 82 for more information).

DAMAGE ASSESSMENT

Prior to development of repair plans or obtaining of permits, it is necessary for the extent of repair to be determined. In order to establish the extent of repair, an assessment of the damage will need to be made. Who makes this assessment is in part a function of whether there is insurance that will cover repair of the damage. If there is insurance coverage, the insurance company will assign an insurance adjuster who will assess the damage and determine the required repairs (see *Paying for Repairs* on page 83 for discussion of insurance coverage). Depending on the extent of damage, the insurance adjuster might also involve an engineer or architect.

Where there is no earthquake insurance coverage, the owner will need to hire a contractor, engineer, or architect to determine the extent of repair. The contractor, engineer, or architect will then make on-site assessments and develop recommendations for repair. This is typically followed by the same consultant developing repair plans to document the extent and details of repair. Depending on the observable damage, the extent of the assessment can vary widely. In some cases, it might be necessary to remove damaged finish materials to determine if there is concealed damage beneath.

One available resource for conducting an assessment is: CEA-EDA-01, *Earthquake Damage Assessment and Repair Guidelines for Residential Wood-Frame Buildings*. This document is primarily written for and used by insurance adjusters, and includes information that might be of help to interested homeowners. It provides a step-by-step guidance on where to look and what to look for when there are signs of potential hidden damage, and when it would be appropriate to hire an engineer or architect.

WORKING WITH CONTRACTORS

When making home repairs, finding a good contractor and conducting business with them in a structured

and professional manner is important to a successful outcome. As with any other major undertaking or investment, some research and planning in advance will be beneficial in helping the work be satisfactorily completed. There are a number of available guide documents for finding, hiring, and interacting with contractors. One such guide from the Federal Trade Commission is noted below. Similar guidelines are available from state contractor's licensing organizations and many local building departments. Use of one or more of these guidelines is highly recommended. This section provides discussion of some highlights.

What you should know before hiring a general contractor

See publication:

<https://www.consumer.ftc.gov/articles/0242-hiring-contractor>

CONTRACTOR SELECTION AND VETTING

Key to a successful outcome is finding the right contractor. Homeowners should interview and get proposals from several contractors in order to get multiple opinions on the cost and duration of repair work. Best sources of recommendations for contractors are neighbors, co-workers, and friends who can relate their experiences with contractors that are working in your area. There are many questions to ask when interviewing a contractor. A few include:

- » Contractor's license number (see *Contractor Licensing* on page 82)
- » Prior experience in repairing damage, especially earthquake damage, or retrofitting homes
- » Names and contact information of references that you can contact
- » Insurance coverage (general liability, workman's compensation, bond number, and certification)
- » Availability and lead time to start work
- » Estimate of time required to complete work

CONTRACTOR LICENSING

In most states, contractors hired to make repairs or retrofits are required to be licensed by the state in which the home is located. Contractors offering services should be asked to provide their license number. Prior to hiring a contractor, the homeowner should contact the state contractors' license board to verify that the license is active, and determine if there are complaints filed against the contractor, in which case additional scrutiny would be appropriate. In most cases, this information can be accessed online or by phone.

ESTABLISHING A WRITTEN CONTRACT

Like any other major transaction, a written contract is a very important document for recording the agreement between the homeowner and the contractor. It is important that the contract provide a reasonably detailed description of the work scope to be completed. When repair plans or descriptions have been developed, these should be referenced in the contract to describe the scope of work. Also included should be the cost of work and schedule of payment. If specific construction schedules have been agreed to, this can also be included.

Hiring a Contractor

A contractor offering to provide services should be able to provide the firm's contractor's license number. You should be able to confirm that the license is valid and current online or by phone.



PAYING CONTRACTORS

Many contractors will ask for a small initial payment or down payment at or just before the start of work. Some states set a maximum amount of down payment that the contractor can request prior to start of work. It is particularly important to limit the amount of down payment following an earthquake or similar event, since homeowners have been taken advantage of in past events. After the initial payment, it is most common for the contractor to be paid for work completed. This involves a review of work completed, followed by invoicing on a bi-weekly or monthly schedule or by phase of work completed. The homeowner should verify to the best of their ability that the work invoiced by the contractor has been completed, and should not pay out ahead of work that can be verified. On occasion in the aftermath of an earthquake or other event, contractors may take advantage of the situation by asking for more money prior to start, or ahead of completed work. It is not recommended that the homeowner pay ahead of work, because any money paid ahead is potentially at risk of being lost.

It is customary for the homeowner to hold off on a final payment (often around 10% of the contract amount) until they can verify the work is complete, the building permit is closed out, and they have created a punch list of any details needing completion and the contractor has addressed all items. The amount of the down payment should be reflected in the contract.

Paying California Contractors

In California, the Contractor's State License Board warns that it is illegal for a contractor to request a down payment of more than 10% or \$1,000 (whichever is lower) of the contract amount.

WORKING WITH DESIGN PROFESSIONALS

When the scope extends beyond repair or replacement of finish materials (such as stucco, gypsum board, and plaster), it may become necessary to involve an engineer or an architect. The engineer or architect would generally conduct an assessment of the extent of required repairs or retrofits and develop plans that can be used to obtain bids from contractors and be submitted to the building department to obtain the permit. The contractor will use the plans developed by the engineer or architect to estimate cost and duration of work. The engineer or architect will also perform periodic observations during the construction of repairs or retrofits. These observations are used to make sure that work is being constructed in general conformance with the repair or retrofit plans, and to help make any required adjustments to the plans based on conditions observed.

All of the recommendations and cautions discussed with respect to hiring contractors apply equally to engineers and architects, and many of the same questions should be asked and information obtained. It is preferable that the engineer or architect proposing to do the work has knowledge of residential construction and repair of damaged homes. Interviewing several engineers or architects before choosing a person or firm to work with is important, as is developing a written contract.

PAYING FOR REPAIRS

Where the homeowner has earthquake insurance, the insurance company is the primary resource for paying for repairs. Most homeowners' insurance sold in the United States does not include earthquake damage. Earthquake insurance is typically purchased as a separate add-on to basic homeowners' insurance policy. It is always safest, however, to confirm with your insurance agent or broker whether there is applicable insurance coverage.

Where insurance coverage is in place for the home, the insurance company will generally take the lead in

Hiring an Architectural or Engineering Firm

An architectural or engineering firm offering to provide services should be able to provide the license or registration number of the architect or engineer having oversight of the work. You should be able to confirm that the license is valid and current online or by phone. If you are not working directly with the person whose name appears on the registration, you are encouraged to contact them by phone to ensure that they are knowledgeable regarding the services being provided.



the assessment of damage and determining extent and estimated cost of repair. Most insurance policies include some level of deductible that the homeowner will be responsible for. Insurance payments are often based on the percentage of the repair or reconstruction work completed, allowing the owner to absorb the cost of the deductible over the course of repairs rather than up front. Like any other business transaction, information provided by the insurance company and their representatives should be reviewed by the homeowner for accuracy and corrected if necessary.

Whether or not you have earthquake insurance, local assistance centers may have resources to help with the cost of repairs, including [United States Small Business Administration \(SBA\)](#) loans and low interest disaster loans.

BUILDING BACK BETTER

When a damaged home is being repaired, this can provide an opportunity to voluntarily build back better and stronger. This might include repairing to a recent building code instead of repairing the home to its pre-earthquake condition. This might also include implementing one or more of the retrofit measures discussed in the *Protect* section, which are believed to provide cost effective strengthening. Although the cost of voluntarily building back better is generally borne by the owner, loans or grants might be available for this mitigation activity. Examples include [SBA Mitigation Loans](#) that can be obtained by home or business owners that have SBA loans for damage repair and [FEMA Hazard Mitigation Grants](#) that state or local governments can apply for.

COMPLETION OF REPAIRS AND RETROFITS AND RETAINING RECORDS

When repair or retrofit permits have been obtained, it is very important that the work be completed to the satisfaction of the building department and the building permit is closed out. If the permit is not properly closed out, it will provide an obstacle for obtaining future permits and sale of the home. The more time goes by, the more complicated and expensive it can become to close out an open permit. When needed for legitimate reasons, extensions to the building permit duration can be obtained.

It is recommended that all records regarding damage assessment and repair or retrofit be retained by the homeowner for future reference. Most important are permit records, plans, the contract with the contractor performing the repairs and retrofits, and contracts with architects and engineers if applicable. This information is useful if questions arise from the building department, for reference if future work is planned for the home, and to provide to a future owner upon sale. It provides documentation that work done was conducted in accordance with the applicable building department regulations.

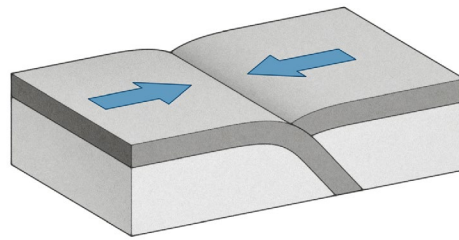
This page intentionally left blank.

Supplement: Earthquakes Across America

In this section you will learn about plate tectonics of the seismic regions throughout the United States. The section covers the following: Subduction zone (Alaska, Pacific Northwest, Puerto Rico), transform boundary (California, Rocky Mountains), intraplate earthquakes (New Madrid, South Carolina), Eastern United States (Oklahoma), and Hawaii. You can also use the map on [page 7](#) to navigate to your region of the country.

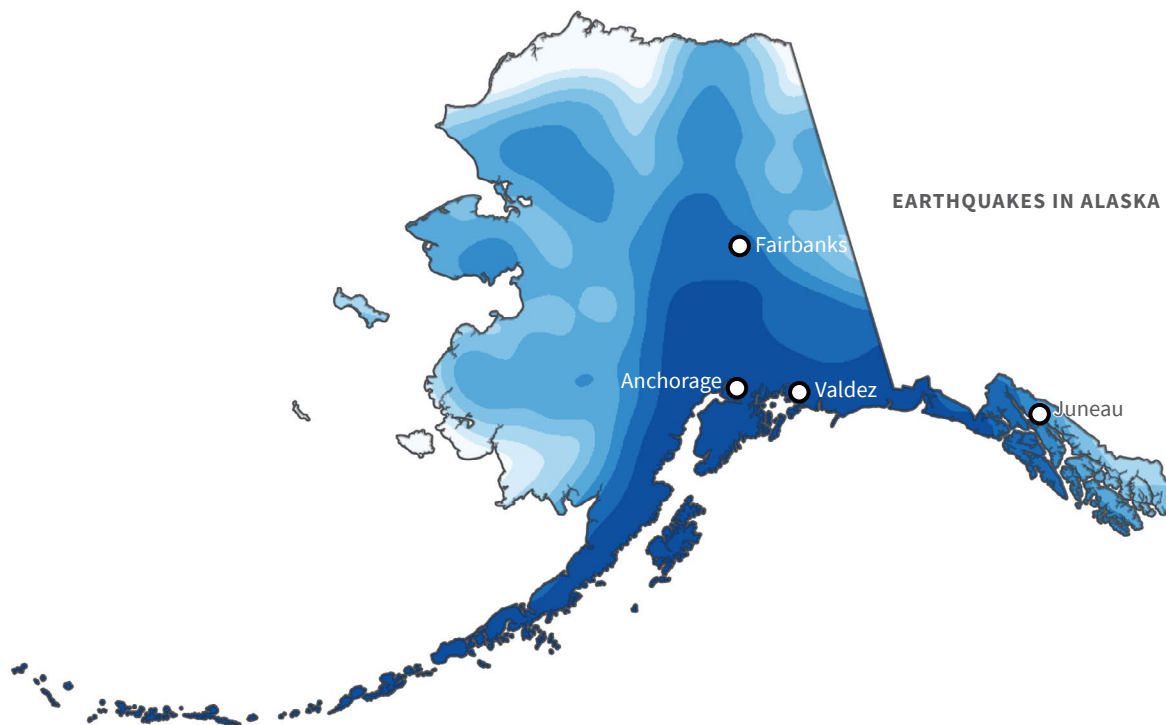
SUBDUCTION ZONE

What happens when two plates “converge” (run into each other) depends on whether the boundary is at a continent or an ocean. The ocean floor created at the mid-ocean ridges is made from dense rock from the mantle of the earth, and it is heavier than the rocks in continents. This is why ocean floor is at a lower elevation than the continents. When an ocean floor runs into a continent, the heavier ocean floor gets pushed under the lighter



continent and goes back down into the mantle. If two ocean floors run into each other, one will go under the other in an oceanic subduction zone, usually creating some islands in the top plate. If two continents run into each other, they are both too light to go down, so they go up – creating tall mountains such as the Himalayas or the Alps.

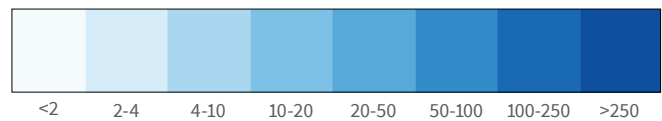
Earthquakes on subduction zones create tsunamis. They are usually underwater so the movement on the fault shifts the seafloor, displacing the water above the fault, creating the tsunami. Subduction zones also make the largest earthquakes. The largest earthquake ever recorded, a magnitude 9.5 in Chile in 1960, was on a section of a subduction zone more than 800 miles long. The second largest was in Alaska.



ALASKA—AMERICA’S LARGEST EARTHQUAKE

March 27, 1964 was Good Friday. Schools in Anchorage were closed that day, and many businesses closed early as people attended church services and prepared for the holiday weekend. The population of Alaska had just reached a quarter million people, and over half lived in the Anchorage area. At 5:36 PM, the lives of all these people were changed forever. An earthquake began at an epicenter about 80 miles east of Anchorage. The earthquake grew from its epicenter to include a fault over 500 miles long, and became the largest earthquake ever recorded in the United States – a magnitude-9.2 earthquake!

At first, the shaking in Anchorage was not very strong, especially for people in Alaska who are used to earthquakes. But the shaking did not stop. As the rupture grew from its epicenter, a “rupture front” passed down the fault. In all earthquakes, the rupture front travels at about 2 miles per second, so larger earthquakes on longer faults last a longer time. This particular earthquake, sometimes known as the Great Alaskan Earthquake, lasted for almost 5 minutes.



Expected number of occurrences of damaging earthquake shaking in 10,000 years.

The fault that produced this earthquake is the Aleutian subduction zone. The seafloor under the Pacific Ocean is sliding to the northwest and sinking down under Alaska. As it sinks down, it pulls down the ocean floor and creates a trench. The deep trenches of the oceans are all there because of subduction zones.

Just because it was the largest American earthquake does not mean the Good Friday Earthquake produced the strongest shaking in America. The fault in the Great Alaskan Earthquake was located offshore, a long way away from Anchorage. The intensity of the shaking had died off as the waves traveled through the earth, so the shaking in Anchorage was not nearly as strong as in some other earthquakes. The coastal towns such as Valdez experienced stronger shaking, but even there, the maximum acceleration of the ground (one way to measure shaking) was less than that recorded in some



The Turnagain Heights landslide in Anchorage, Alaska. Seventy-five homes twisted, slumped, or collapsed when liquefaction of subsoils caused parts of the suburban bluff to move as much as 2,000 feet downward toward the bay, forming a complex system of ridges and depressions. The slide developed because of a loss in strength of the soils, particularly of lenses of sand, that underlay the slide.

PHOTO COURTESY OF NOAA NATIONAL GEOPHYSICAL DATA CENTER

Californian earthquakes where the faults are closer to where people live.

The shaking from the earthquake caused widespread damage along the coast of Alaska. Even more damage was caused indirectly, by the ground losing its ability to hold up buildings through liquefaction. This phenomenon was responsible for widespread slumping and landslides across Anchorage. See image above.

Having the fault offshore meant that the shaking in Anchorage was less than it would have been from a nearby fault. It also meant that the earthquake created a tsunami. The fault was over 500 miles long, about 50

miles wide and that stretch of ocean floor moved over 60 feet. The water displaced by this fault caused a tsunami. Because the part of the subduction zone that moved in 1964 points toward the North American continent, the worst damage in 1964 was along the West Coast. In Northern California, at Crescent City, the tsunami was 21 feet high and 10 people were killed. Even farther away, in Los Angeles, one person died after being swept away, and the Port of Los Angeles sustained significant damage.

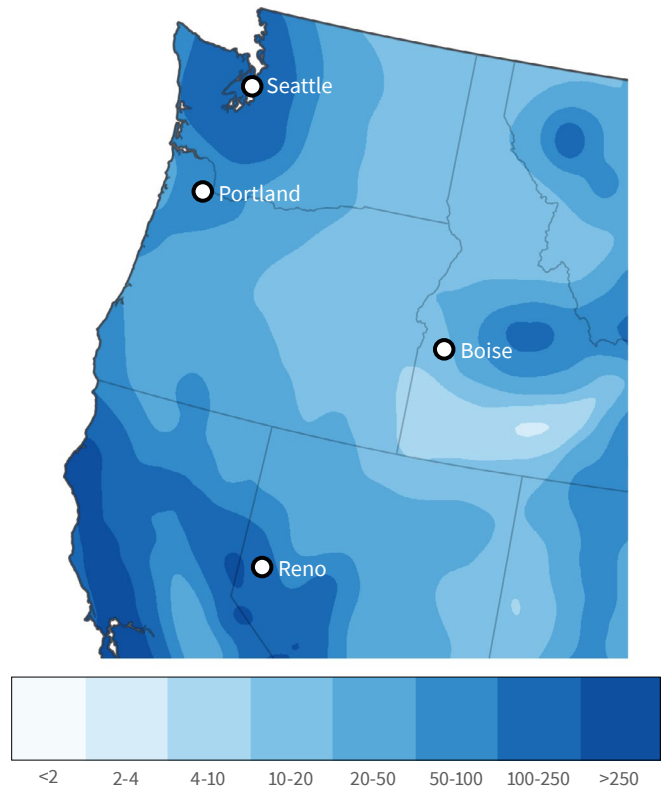
PACIFIC NORTHWEST—THE HIDDEN EARTHQUAKE

Alaska is not the only subduction zone in the United States. A somewhat smaller one, “only” 650 miles long, lies off the Pacific Northwest from Cape Mendocino in Northern California to Vancouver Island in British Columbia: the Cascadia subduction zone. Unlike most other subduction zones, which have a large number of earthquakes all the time, the Pacific Northwest has been relatively quiet.

Researchers have uncovered information that prove that the Pacific Northwest has had very big earthquakes and will again. First, a United States Geological Survey (USGS) seismologist showed that the lack of smaller earthquakes over the last hundred years did not have to be a sign that big ones were impossible and that, in fact, the seismological characteristics of the Cascadia zone were most similar to Chile—the source of the largest earthquakes in the world. Next, another USGS geologist realized that if this was right, there had to be geologic evidence of past big earthquakes. Several locations along the Pacific Northwest coast have “ghost forests,” – groves of dead red cedar trees that had died but were still standing. He showed that these forests could be explained by the lowering of the ground elevation that happens in subduction zone earthquakes. The ground level of the forest was lowered to the point that salt water penetrated into the soil, which killed the roots but left the forest still standing. By studying tree rings, he also found that many of the ghost forests were formed in the winter of 1700.

The third piece of evidence came from Japan. A Japanese seismologist studied the records of an “orphan tsunami”—a tsunami that hit the Japanese coast without records of a Japanese earthquake—that had occurred on January 27, 1700. He showed that the patterns of wave heights could not be matched with any known tsunami from South America or Alaska, but fit what would be expected from a very large earthquake on the Cascadia subduction zone.

EARTHQUAKES IN THE PACIFIC NORTHWEST



Expected number of occurrences of damaging earthquake shaking in 10,000 years.



Ghost forest in Washington State.

PHOTO COURTESY OF BRIAN ATWATER, UNITED STATES GEOLOGICAL SURVEY

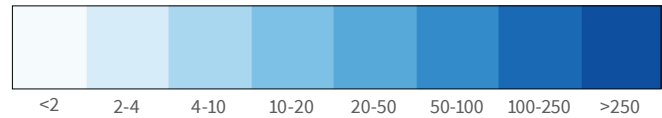
Putting all these pieces of the puzzle together, we see that there must have been a very large earthquake at the Cascadia subduction zone on January 26, 1700. Because the ghost forests show up in so many places on the coast (remember the length of the fault controls the magnitude), it must have been around a magnitude 9.0.

Any place that has had a big earthquake can have one again—the fault is still there and the plates are still moving. The rate at which the plates are coming together in the Pacific Northwest means that earthquakes the size of the 1700 earthquake should happen about once every 500 years. Cores taken from the seafloor off the Oregon coast show evidence of big earthquakes occurring about every 250 years. To have this many earthquakes means some of them have to be smaller than the magnitude 9.0 that occurred in 1700.

Even though the Cascadia subduction zone can produce larger earthquakes (around magnitude 9.0) compared to California (around magnitude 8.0), the losses suffered will probably still be greater in California. That is because magnitude alone does not reveal what the shaking or the damage will be. Magnitude only tells how long the fault is and therefore how large an area will be subjected to strong shaking. However, if much of that area is under the ocean, no one is there to get hurt.

The Pacific Northwest also has smaller, slower moving faults in the rocks that are beneath people. The 1965 Puget Sound and 2001 Nisqually Earthquakes both happened in the rocks beneath greater Seattle. For example, the Seattle Fault and the Portland Hills Fault run through the cities of Seattle and Portland, respectively. These faults produce earthquakes much less frequently than the Cascadia Fault and will affect a much smaller area. But the damage near one of these faults could be greater in a local earthquake than in the Cascadia Earthquake.

EARTHQUAKES IN PUERTO RICO



Expected number of occurrences of damaging earthquake shaking in 10,000 years.

PUERTO RICO—THE IGNORED SUBDUCTION ZONE

The third American subduction zone is an oceanic subduction zone – formed when two oceanic plates collide. The American territory of Puerto Rico is on the boundary between the North American and Caribbean Plates and has a very high rate of earthquakes. The Caribbean Ocean is one of the more complex plate tectonic settings with the North America, Caribbean South American, Nazca, Cocos, and two microplates (Panama and North Andes) interacting around the edges of the Caribbean Plate. The islands of the Caribbean are formed as the North American Plate goes under the Caribbean Plate.

One of the defining features of a subduction zone is the presence of deep earthquakes. In most parts of the world, the rocks get so hot only a few tens of miles into the earth that earthquakes are not possible. But in a subduction zone, cold rock is being pushed into the earth, so the rocks stay brittle deeper in the earth.

In the Caribbean, some earthquakes can be more than 100 miles deep. These earthquakes rarely cause damage, not because they produce different types of shaking, but because everyone is at least 100 miles away from 100-mile deep earthquakes. Others, like the series of earthquakes in 2020 in southwestern Puerto Rico, are shallow which puts people nearer the earthquakes and increases the shaking.

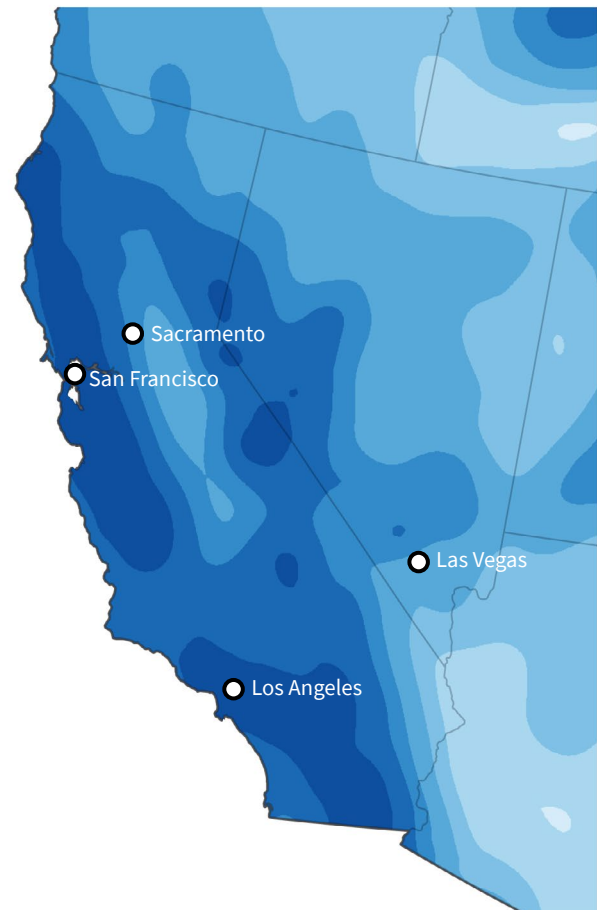
TRANSFORM BOUNDARY

The Pacific Northwest has a subduction zone because a small plate called the Juan de Fuca Plate is being created by a mid ocean ridge just offshore. Coming south into California, the Juan de Fuca Plate disappears at Cape Mendocino. South of there, the North American and Pacific Plates are sliding past each other, not colliding, forming a “transform boundary.” Most of this motion happens on the San Andreas Fault system, but it is not a perfect fit. A bit of North America is getting dragged along with the North American Plate, leading to stretching of an extended boundary through Nevada, Idaho, and Utah.

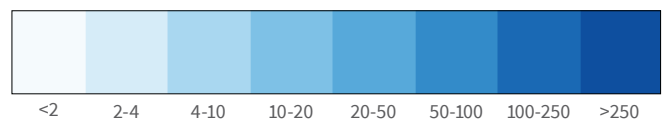
CALIFORNIA—WHERE THE LOSSES ARE

In California, two plates at the plate boundary are moving past each other, and the faults that are producing this motion are mostly on land. The San Andreas Fault system carries most of the plate motion and therefore has earthquakes the most often. But in fact, there are many more faults with a total of 225 faults in California in the national active fault database maintained by the USGS. More than 90% of these faults are on land and right underneath people’s homes. Because it has so many fault lines with so many people, California is expected to have more earthquake losses than any other state. In comparison, Alaska has more earthquakes, but there are fewer people and fewer structures to be damaged.

Even though the San Andreas Fault is responsible for over half of the total movement, it produces much less than half of the earthquakes in the state. The last big San Andreas earthquake was in 1906 with an epicenter near San Francisco. The part of the fault that broke extended from 80 miles south of San Francisco to Cape Mendocino, a distance of about 270 miles running just offshore of the city. It killed several thousand people (records from the time are not complete and the total death toll is still debated), triggered fires that burned most of the city of San Francisco, and set back the economy for decades.



EARTHQUAKES IN CALIFORNIA



Expected number of occurrences of damaging earthquake shaking in 10,000 years.

The USGS created a detailed scenario to understand what a future, large San Andreas earthquake would do to California. They chose a section of the fault in Southern California that has not moved in 330 years, even though its average time between earthquakes is approximately 150 years, making it one of the most likely to produce a big earthquake in the near future. Called the *ShakeOut* scenario, it shows that our investment in building codes that try to keep the buildings from killing people has paid off, and most of the life loss will be limited to older buildings that do not meet modern codes. The chance of dying in an earthquake, even in California, is much

smaller than the chance of dying in a car accident. Still, the economic losses could be staggering. Estimates for losses in Southern California alone are \$213 billion, but the impact would be even more extensive. For instance, the ports of Los Angeles and Long Beach bring in about 40% of the total imports to the United States. They are far enough away from the San Andreas Fault that they may not suffer significant damage, but the highways and railroads that transport cargo to the rest of the United States all cross the San Andreas Fault and will be broken in the earthquake. California's economy represents about 1/8 of the United States economy and the majority of that economic activity is in the area that will be affected by this one earthquake. The impact will be felt across the country.

This is an important fact for us to remember about potentially catastrophic natural hazards. An event is a disaster when it destroys your house. It becomes a catastrophe when so many people are affected that the regional or even national economy is damaged. Modern society has become much more interconnected and we all have a stake in reducing losses from natural disasters anywhere in the county.

Although geologists consider the San Andreas Fault system as the boundary between the North American and Pacific Plates, it only accounts for two-thirds of the motion between the two plates. That means that one-third of that motion is happening on other faults. Some, like the San Jacinto Fault in Southern California and the Hayward Fault in Northern California, are parallel to the San Andreas and run close to the main fault and are often called the "San Andreas System." There are hundreds of other faults, because in the rocky crust, one piece will snag on another and break at weak points. The complete plate boundary (the area over which all the relative motion is distributed) actually extends all the way out to Utah.

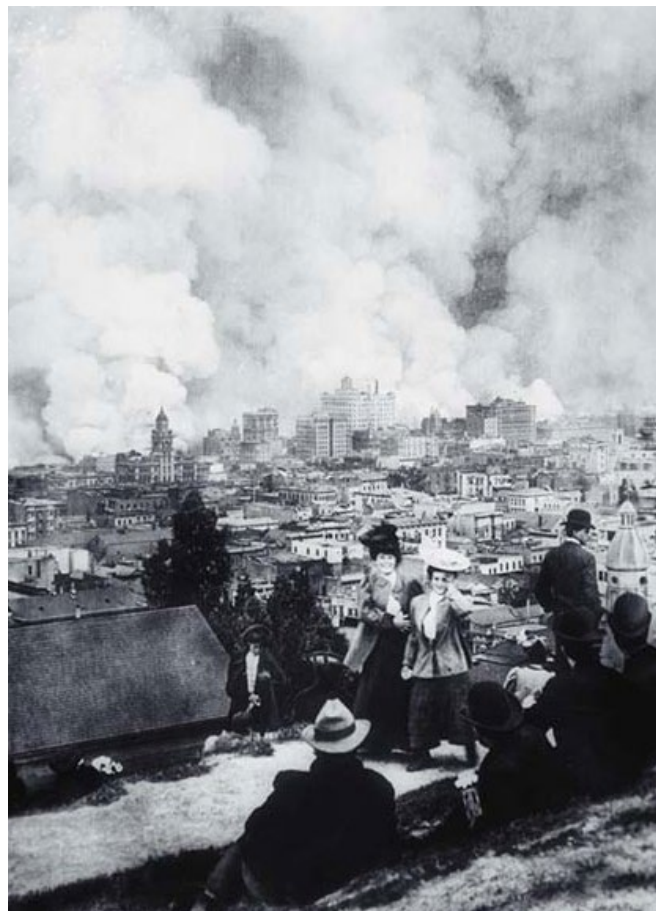


Photo of San Francisco fires following the 1906 Earthquake.
PHOTO COURTESY OF SAN FRANCISCO MUSEUM OF MODERN ART,
LAST ACCESSED 9/25/19

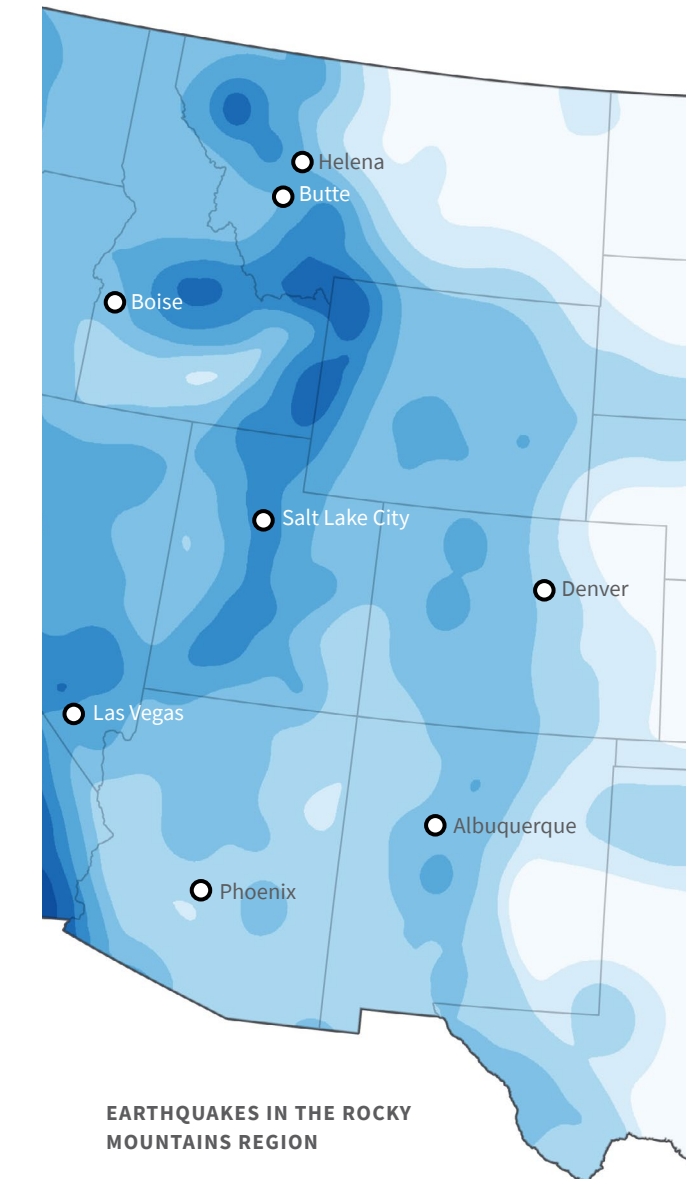
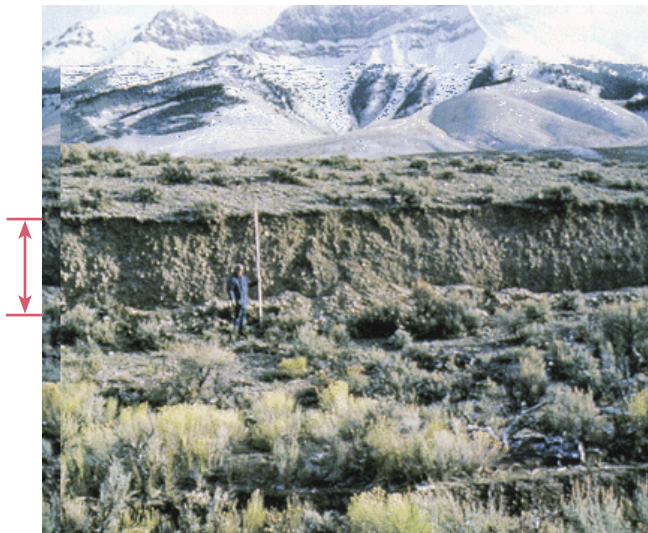
The earthquakes that occur on these faults are much smaller than the plate boundary earthquakes but still pose a large risk because many of the faults are near people. The 1994 Northridge (Los Angeles) and 2000 Nisqually (Seattle) Earthquakes are examples of "smaller" earthquakes—they were magnitude 6.7 and 6.8—that could do a lot of damage due to their proximity to large populations. The area of worst shaking in Northridge was as intense as the worst shaking in the 1906 San Francisco Earthquake but it did not last as long. Northridge lasted for only 7 seconds, while 1906 lasted for 100 seconds.

THE ROCKY MOUNTAINS—THE SORT-OF PLATE BOUNDARY

The plate boundary extends through Nevada and Idaho into Utah. Extends is the right word here for another reason. The area between the Sierra Nevada in Eastern California and the Wasatch Mountains in Utah is literally extending, slowly being stretched out as California holds on to the Pacific Plate and gets dragged slightly northwestward.

The total movement over Nevada and Utah is less than 20% of the movement that happens on the San Andreas system, so the faults in this area do not have as many earthquakes as in California. However, even this small fraction of movement can be quite damaging. The most recent major earthquake in this region (and largest ever recorded in Idaho) was the magnitude-6.9 Borah Peak Earthquake in 1983. This earthquake pushed up Borah Peak and made it about 6 feet taller than it had been before the earthquake.

The photographs below and the following page show how the fault broke to the surface of the earth along a 20-mile stretch, pushing the mountain up and dropping the valley down. This earthquake is notable because it is one of the few cases where we have eye witness accounts of the fault breaking. A couple were out camping and saw the fault scarp form, moving up 15 feet within a few seconds. They described it like a zipper opening, which



Borah Peak scarp in 1983.
PHOTO COURTESY OF UNITED STATES GEOLOGICAL SURVEY



Borah Peak scarp showing how it extends for miles and pushes up mountain.

PHOTO COURTESY OF UNITED STATES GEOLOGICAL SURVEY

is consistent with our seismologic records that show the rupture front moving down a fault. The earthquake also killed 2 people and caused about \$12.5 million in damage. The damage was mostly to the type of masonry building that are no longer built in more seismically active states.

The 1959 Hebgen Lake Earthquake in Montana was also part of this extended plate boundary. Although it was larger than the Borah Peak Earthquake, at magnitude 7.3, it was in a wilderness area near Yellowstone National Park, so there was not as much damage. However, as often happens with very large earthquakes in mountainous areas, it triggered numerous landslides. Most of the 28 deaths were caused by rockslides that covered the Rock Creek Public Campground on the Madison River, about 9.5 kilometers below Hebgen Dam. Another huge avalanche of rock, soil, and trees cascaded from the south side of the Madison River Canyon and blocked the gorge, stopping the flow of the Madison River. Within a few weeks, a lake over 150 feet deep formed behind the slide.

INTRAPLATE EARTHQUAKES

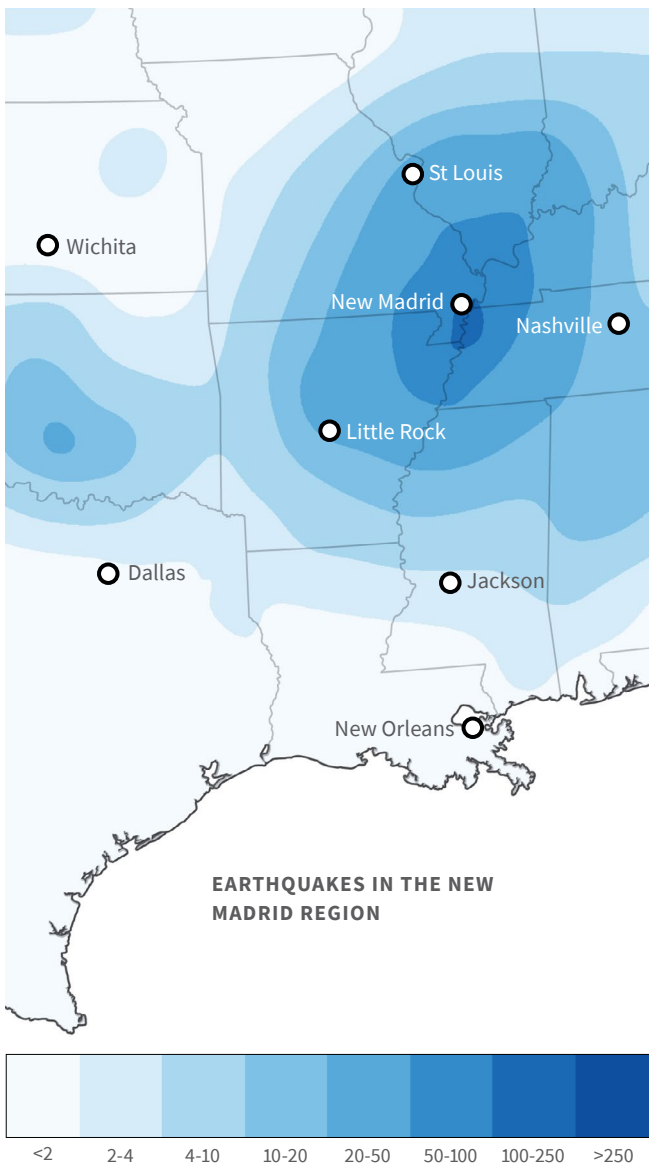
Although the plate boundary may be diffuse, it does end by the time you get to the Rockies. Geodetic measurements show that the eastern part of the North American continent is a coherent block without much motion between the different parts. The rate of earthquakes is also much lower, but it is not zero. Earthquakes of magnitude 7.0 and larger have occurred in the eastern United States in what we call “intraplate earthquakes” — earthquakes that happen within a plate where the relative motion is very small. Most of the intraplate areas around the world have some low level of earthquakes. Most scientists believe these earthquakes result from residual stresses and are most likely to occur at locations of weakness in the crust.

NEW MADRID—ONCE, BUT NO LONGER, THE BIGGEST

The most famous of the intraplate earthquakes in the United States are those near New Madrid, Missouri. Four earthquakes large enough to cause substantial damage happened between December 1811 and February 1812, and thousands of smaller earthquakes were felt as well. These earthquakes did widespread damage in that area of the Midwest and were felt over much of Eastern United States. The largest of the New Madrid Earthquakes was reported to have moved furniture in the White House and rung church bells in Boston. At one time, these were

thought to be the largest earthquakes ever recorded in the United States but we now know that is not the case.

After the measurement of magnitude was invented in the early 20th century, scientists tried to understand how big older earthquakes were by looking at the area that felt them. Reports of shaking could be gathered from newspaper articles and diaries describing what people felt and compiled into a map and then compared with similar reports for an earthquake with a known magnitude. The New Madrid Earthquakes were felt over a much larger area than the 1906 San Francisco Earthquake which was about magnitude 8.0. Based on this information, the largest New Madrid Earthquake was estimated to be very large, perhaps as large as magnitude 8.7. Today, we know that the largest of the New Madrid Earthquakes was only magnitude 7.5. How did we get such a large number when the earthquakes were actually much smaller? The answer lies in the difference between the rocks in the eastern and western United States.



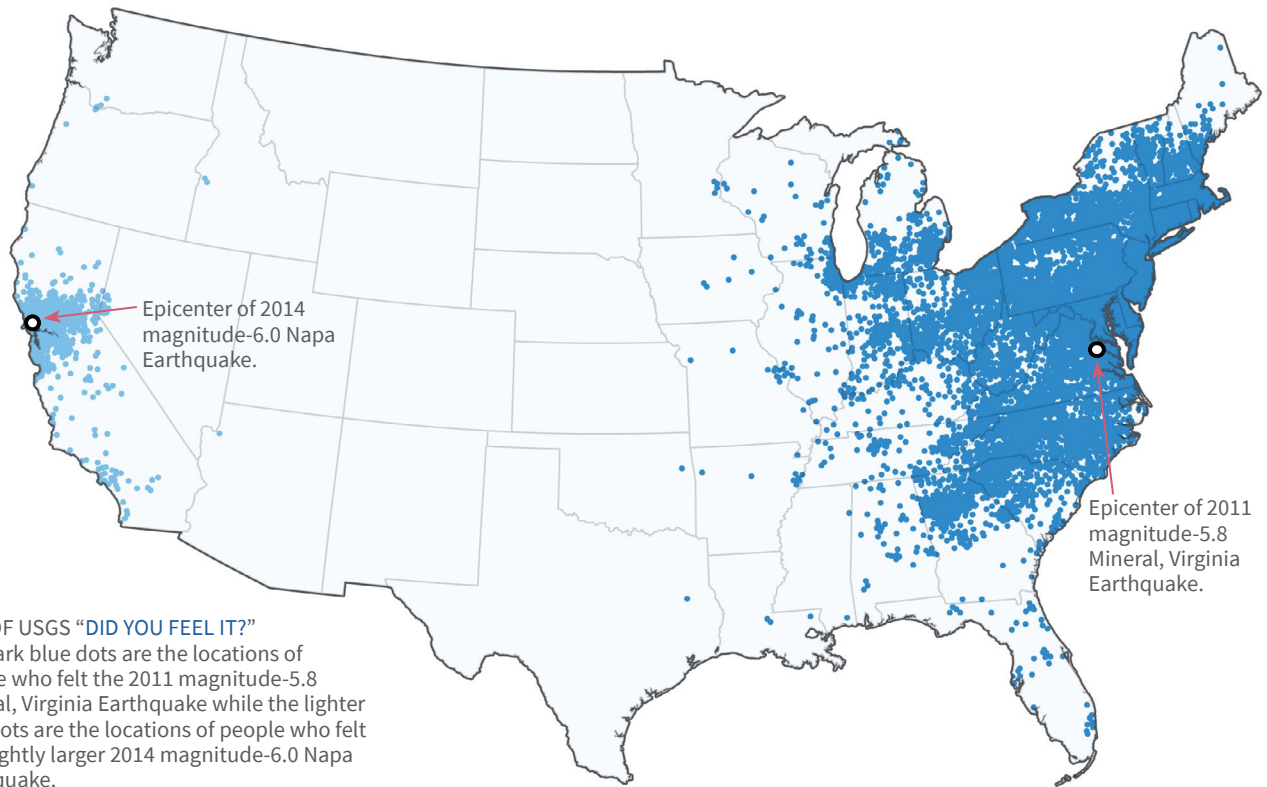
Expected number of occurrences of damaging earthquake shaking in 10,000 years.

The rocks in the western United States are often quite young (by a geologist's reckoning—only a few tens of millions of years old), relatively warm, and broken up by many faults. In contrast, the rocks in the East are old (often more than a billion years), cold, and solid. Just as a cracked bell cannot ring as loudly as a solid one, the seismic energy traveling through the many faults of the Western United States dies off more quickly than energy traveling through the solid old crust of the East Coast.

We can see how this works by comparing the 2011 Virginia Earthquake of magnitude 5.8 to the slightly

larger 2014 Napa, California Earthquake of magnitude 6.0. The maximum intensity is slightly higher for the magnitude-6.0 California Earthquake, but the Virginia Earthquake was felt over a much larger area, all the way to Maine.

The New Madrid region continues to have a higher rate of earthquakes than surrounding territory, even today. Is this because the risk in New Madrid is higher than the rest of the intraplate region? Or are we just seeing a very long aftershock sequence to the 1811-1812 mainshocks?



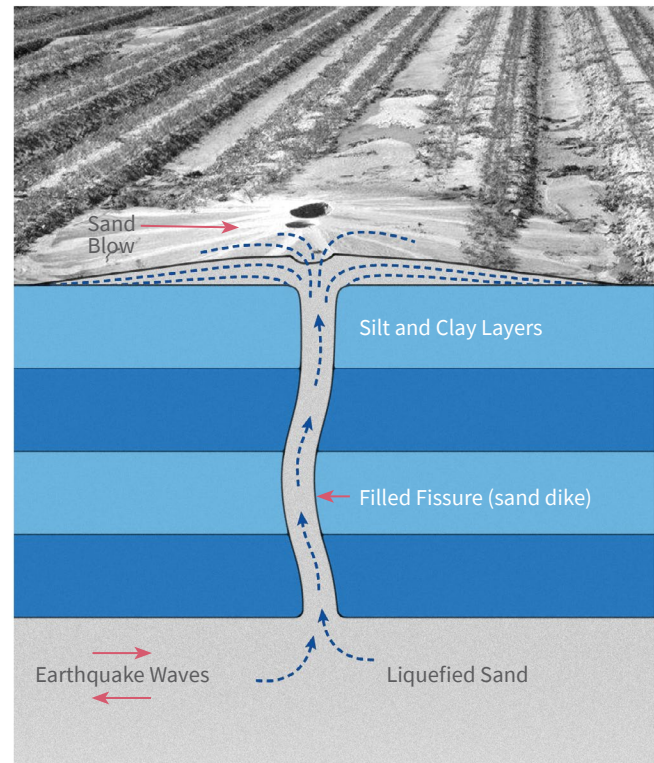
MAP OF USGS “DID YOU FEEL IT?”
The dark blue dots are the locations of people who felt the 2011 magnitude-5.8 Mineral, Virginia Earthquake while the lighter blue dots are the locations of people who felt the slightly larger 2014 magnitude-6.0 Napa Earthquake.

In intraplate regions, if there is only one recorded earthquake, then another is not very likely in the near future. However, if we can find evidence that multiple large earthquakes had occurred there in the past, then it would be much more likely for a large earthquake to occur there again. Here is where geology can help us.

The intensity of the shaking in 1811 was so prolonged that it caused liquefaction, making the sand behave temporarily as a liquid or quicksand. When the loose soil that liquefies is buried under a denser soil that does not liquefy, the quicksand cannot flow out of the way. Instead, it expands until it breaks through the overlying soil and spurts into the air like a fountain. It falls back to the earth and can be seen as circular sandblows. The chance of liquefaction goes up the longer the soil is shaken, so sandblows are a good sign that a pretty big earthquake has happened.

By cutting trenches into areas that liquefied in 1812, geologists have found older sandblows that were buried by floods. The sediments in the old floods can be dated, and they show us three previous earthquakes large enough to create sandblows that happened around 1450 A.D., 900 A.D. and 2350 B.C. If four different large earthquakes occurred there before, then it is highly possible for a fifth to occur. That is why the New Madrid region is thought to have the highest earthquake hazard east of the Rockies.

HOW SAND BLOWS FORM



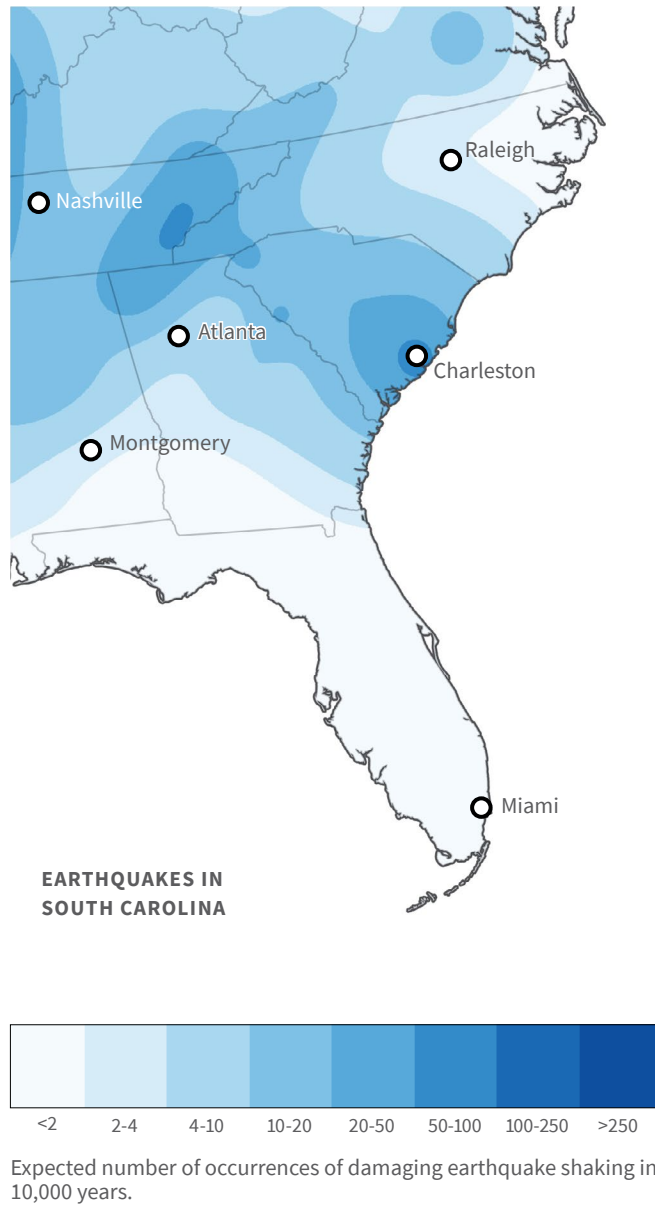
During earthquake shaking, a subsurface layer of sand will settle, compressing the spaces between the sand grains. If those spaces are filled with groundwater, that water becomes compressed and the pressure in it increases. When the pressure in the water is great enough, it will force its way to the surface carrying the sand with it.

ADAPTED FROM THE UNITED STATES GEOLOGICAL SURVEY

SOUTH CAROLINA

South Carolina is the other intraplate region that has had a magnitude-7 earthquake in historic time. The 1886 Charleston, South Carolina Earthquake was felt across the eastern United States, from Chicago to Boston and from Louisiana to Cuba. The shaking was so violent that rumors sprang up that Florida had broken off from the continent. Charleston had only 49,000 residents and yet suffered losses exceeding \$8 million. Over 80% of the houses of Charleston were rendered uninhabitable.

Like New Madrid, the sediments around Charleston show that 1886 was not the only large earthquake. Geologists estimate 7 events have occurred in the last 6,000 years.

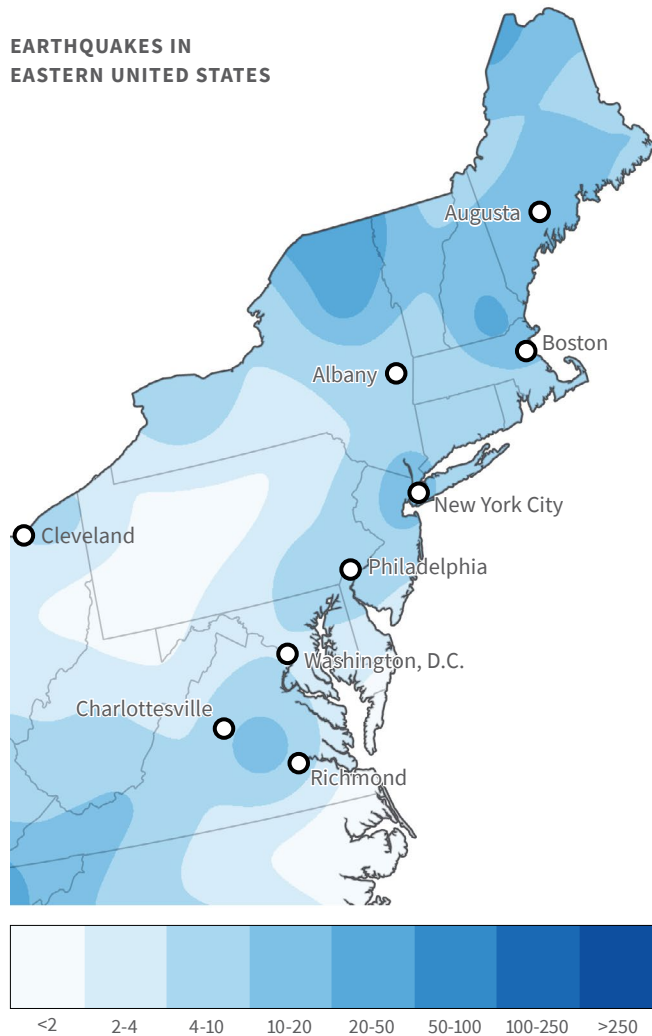


EASTERN UNITED STATES

Much of the eastern United States has had some historic earthquakes. With a very low rate of earthquakes and only a few hundred years of history, the eastern United States poses a question that cannot be answered with absolute certainty. We have a large intraplate region with a few number of large earthquakes. Many locations have had earthquakes about magnitude 5 or 6 but not larger. Are these locations more dangerous than places that have only had magnitude-2 earthquakes? The [National Seismic Hazard Map](#) from the United States

Geological Survey makes a compromise. They consider the previous hot spots to have a higher likelihood for a future earthquake to occur, but everywhere else has at least a very low possibility. The areas of the map with darker colors have had larger earthquakes (magnitude 4 to 6) in the last several hundred years. An example is the area east of Charlottesville, Virginia. There are regular small earthquakes in that region, including a magnitude 4.5 in 2003 and a larger earthquake in the 19th century. The largest earthquake ever recorded in Virginia, the 2011 Mineral, Virginia Earthquake of magnitude 5.8, occurred within this long time cluster. Because the shaking extended over a large area and that area is densely populated, we estimate that more Americans felt the Mineral Earthquake than any other earthquake in American history.

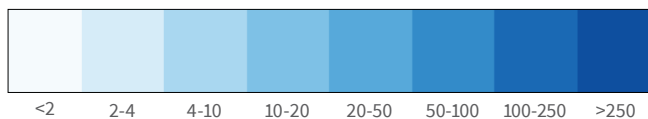
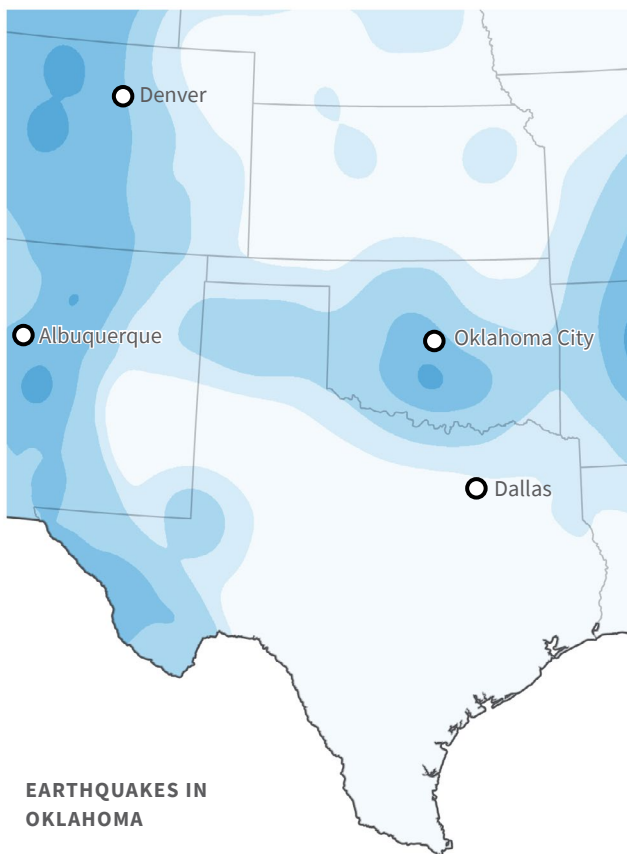
Much of the seismicity in the eastern United States is around the Appalachian Mountains. The Appalachians were formed over 400 million years ago when a subduction zone formed and then grew even higher as continents collided forming the Pangea supercontinent. All of those collisions left behind faults and zones of weakness that can respond to the slow stresses within the current North American Plate.



Expected number of occurrences of damaging earthquake shaking in 10,000 years.

OKLAHOMA—HUMAN-MADE EARTHQUAKES

The newest type of intraplate earthquake is human-made. Earthquakes happen when the stress pushing sideways on the fault overcomes the friction caused by stress pushing the fault together. We have known for a long time that the frictional resistance is reduced by the pressure of water in the pores of the rock. When the pore pressure goes up, the stress needed to start slipping goes down, and sometimes an earthquake results. The most direct way to increase the pore pressure is by pumping fluids into the ground. We have seen a significant increase in the number of earthquakes in the intraplate regions where the extraction of oil and gas is causing



Expected number of occurrences of damaging earthquake shaking in 10,000 years from natural hazards. The hazard from human-made earthquakes are not shown because we do not think we will continue pumping fluids to cause these earthquakes for 10,000 years.

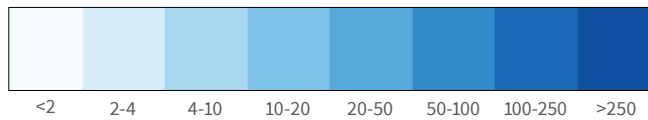
more pumping of ground fluids to take place, such as in Texas, Colorado, and Alabama.

Pumping at shallow depths does not make much difference because earthquakes generally do not start in the shallow crust. Most types of hydraulic fracturing (or “fracking”) are shallow because the oil reservoirs are shallow. We see some earthquakes directly from fracking but they have been small – the largest have only been around magnitude 2 to 3.

To cause larger earthquakes, we need to change the pore pressure at the greater depths where the earthquakes begin. The two common reasons why fluids are pumped deeper are geothermal energy production and disposing of wastewater created through oil extraction. A magnitude-5.1 earthquake in Imperial County of California in 2005 was likely the result of geothermal energy production.

The largest earthquakes we have seen caused by pumping have occurred in Oklahoma. Many wells in Oklahoma produce large quantities of very saline water as well as gas. It is too salty for drinking water, so it is reinjected into disposal wells. This has led to a large increase in the number of earthquakes, so much so that in 2014, Oklahoma recorded more earthquakes than California. The rate of pumping has been reduced in Oklahoma and that has led to a decrease in the number of earthquakes since then.

Oklahoma is not the only location with human-made earthquakes. The United States Geological Survey has started creating a companion map for the National Seismic Hazard Map to show the risk from these induced earthquakes. Unlike the National Map that shows the risk for 50 years, the induced seismicity map shows the hazard for just the next year. If the pumping patterns were to change, so would the rate of earthquakes.



Expected number of occurrences of damaging earthquake shaking in 10,000 years.

HAWAII—THE INTRAPLATE “HOT SPOT”

Hawaii is famous for its volcanoes and the earthquakes that often accompany the eruptions, but for a long time, geologists wondered how they fit into the plate tectonic picture. Hawaii is in the middle of the Pacific Ocean Plate with no plate boundary for thousands of miles. An explanation was found in a theory about “mantle plumes.”

Below the crust of the earth is its mantle. As you go deeper in the earth, it gets hotter. It is hot enough in the mantle that the rocks soften and part can be molten. Mantle plumes are places where the mantle is extra hot. Just as hot air rises, so does hot rock. In a few places in the world, the plume breaks through the crust, creating volcanoes such as those of Hawaii and Yellowstone. The different Hawaiian Islands formed as the Pacific Ocean Plate has passed over the plume. Kauai (in the northwest) is the oldest island, and it has been carried away from the plume so that it no longer has an active volcano or earthquakes. The islands get progressively younger toward the southeast, but only Maui has any sign of activity in the volcano. Most of the current volcanic activity is in the big island of Hawaii, and that is where most of the earthquakes are as well.

Earthquakes in Hawaii fall into two big categories. First are the ones that result from the passage of magma from the magma chamber to the surface. As the magma passes through conduits, it stresses the rock around it and sets off tremors that are usually small. They are often detectable by humans and can be warning signs that the volcano may soon erupt. They are used by volcanologists to track the movement of the magma and predict the time of the eruption. As the eruptions get bigger, so do the earthquakes. A magnitude-6.9 earthquake was part of the beginning of the big eruption that ran through the eastern rift zone of the Big Island in 2018. Over 60 earthquakes above magnitude 5.0 accompanied the collapse of the Kilauea Crater in the summer of 2018.

The second type of earthquake are non-volcanic earthquakes due to movement on a fault. Most of the faults around Hawaii are caused by slumping along the flanks of the volcano. An extraordinary amount of lava has come out of the Hawaiian volcanoes, creating mountains that measure more than 30,000 feet high from seafloor to mountaintop. That large amount of rock carries tremendous weight, and gravity pulls it back down. Events like the 1975 magnitude-7.2 Kalapana and the 2006 magnitude-6.7 Kiholo Bay Earthquakes resulted in the flanks of the volcano sinking deeper underwater.

Resources

Earthquakes Across America

USGS, *Did You Feel It?*, United States Geological Survey, Reston, Virginia.
<<https://earthquake.usgs.gov/data/dyfi/index.php>>

USGS, *Introduction to the National Seismic Hazard Maps*, United States Geological Survey, Reston, Virginia.
<<https://earthquake.usgs.gov/monitoring/anss/>>

USGS, *The Modified Mercalli Intensity Scale*, United States Geological Survey, Reston, Virginia.
<https://www.usgs.gov/natural-hazards/earthquake-hazards/science/modified-mercalli-intensity-scale?qt-science_center_objects=0#qt-science_center_objects>

Prepare

American Red Cross, *Disaster Preparedness Plan*, American Red Cross, Washington, D.C.
<<https://www.redcross.org/get-help/how-to-prepare-for-emergencies/make-a-plan.html>>

American Red Cross, *Safe and Well*, American Red Cross, Washington, D.C.
<<https://safeandwell.communityos.org/cms/index.php>>

CEA, *Personal Preparedness – How to be Prepared, for an Earthquake*, California Earthquake Authority, Sacramento, CA.
<<https://www.earthquakeauthority.com/California-Earthquake-Risk/Personal-Preparedness>>

CUSEC, *Earthquake Safety and Preparedness*, Central United States Earthquake Consortium, Memphis, Tennessee.
<<https://cusec.org/>>

DHS, *www.Ready.gov*, Department of Homeland Security, Washington, D.C.
<<https://www.ready.gov/>>

ECA, *The Seven Steps to Earthquake Safety*, Earthquake Country Alliance, Los Angeles, California.
<<https://www.earthquakecountry.org/sevensteps/>>

FEMA, 2012, *Reducing the Risks of Nonstructural Earthquake Damage, A Practical Guide*, FEMA E-74, Section 6.4.2.4 Water Heaters, prepared by the Applied Technology Council for the Federal Emergency Management Agency, Washington, D.C.
<<https://www.fema.gov/media-library/assets/documents/21405>>

FEMA, 2014, *Earthquake Home Hazard Hunt*, FEMA 528, Federal Emergency Management Agency, Washington, D.C.
<<https://www.fema.gov/media-library/assets/documents/3261>>

FEMA, 2017, *Earthquake Safety Checklist*, FEMA B-526, Federal Emergency Management Agency, Washington, D.C.
<<https://www.fema.gov/media-library/assets/documents/3234>>

FEMA, *Community Emergency Response Team (CERT) Training Materials*, Federal Emergency Management Agency, Washington, D.C.
<<https://www.fema.gov/es/media-library/resources-documents/collections/485>>

FEMA, *Earthquake Insurance Infographic*, Federal Emergency Management Agency, Risk Management Division, Washington, D.C.
<<https://www.fema.gov/media-library/assets/documents/179911>>

FEMA, *Earthquake Safety at Home*, Federal Emergency Management Agency, Washington, D.C.
<<https://www.fema.gov/earthquake-safety-home>>

FEMA, *Until Help Arrives*, Federal Emergency Management Agency, Washington, D.C.
<<https://community.fema.gov/until-help-arrives>>

USGS, 2011, *Putting Down Roots in Earthquake Country - Your Handbook for the Central United States*, General Information Product 119, United States Geological Survey, Reston, Virginia.
<<https://pubs.er.usgs.gov/publication/gip119>>

Protect: Restrain Free-Standing Water Heaters

CEA, 2020, *Earthquake Damage Assessment and Repair Guidelines for Residential Wood-Frame Buildings, Volume 1 – General*, CEA-EDA-01 (ATC-143), prepared by the Applied Technology Council for the California Earthquake Authority, Sacramento, California.

DSA, 2014, *Guidelines for Earthquake Bracing Residential Water Heaters*, Department of General Services California Division of the State Architect, Sacramento, California.

FEMA, 2012, *Reducing the Risks of Nonstructural Earthquake Damage, A Practical Guide*, FEMA E-74, Section 6.4.2.4 Water Heaters, prepared by the Applied Technology Council for the Federal Emergency Management Agency, Washington, D.C.
<<https://www.fema.gov/media-library/assets/documents/21405>>

FEMA, 2014, *Earthquake Home Hazard Hunt*, FEMA 528, Federal Emergency Management Agency, Washington, D.C.
<<https://www.fema.gov/media-library/assets/documents/3261>>

ICC, 2015, *2015 International Residential Code*, Section P2801.8, Water Heater Seismic Bracing, International Code Council, Washington, D.C.

Protect: Strengthen Weak Cripple Walls and Anchor Floors

FEMA, 2012, *Simplified Seismic Assessment of Detached, Single-Family, Wood-Frame Dwellings*, FEMA P-50, prepared by the Applied Technology Council for the Federal Emergency Management Agency, Washington, D.C.
<<https://www.fema.gov/media-library/assets/documents/92229>>

FEMA, 2018, *Vulnerability-Based Seismic Assessment and Retrofit of One- and Two-Family Dwellings*, FEMA P-1100 Volumes 1 and 2A, prepared by the Applied Technology Council for the Federal Emergency Management Agency, Washington, D.C.
<<https://www.fema.gov/media-library/assets/documents/175158>>

ICC, 2018, *2018 International Existing Building Code*, Appendix Chapter A3, International Code Council, Washington, D.C.

Protect: Strengthen Improperly Nailed Plywood Siding

APA, 2001, *Engineered Wood Construction Guide*, American Plywood Association, Tacoma, Washington.
<www.apawood.org>

Protect: Strengthen Hillside Home Anchorage to Foundation

FEMA, 2018, *Vulnerability-Based Seismic Assessment and Retrofit of One- and Two-Family Dwellings*, FEMA P-1100 Volume 1, Chapter 6, prepared by the Applied Technology Council for the Federal Emergency Management Agency, Washington, D.C.
<<https://www.fema.gov/media-library/assets/documents/175158>>

PEER, 2000, *Framing Earthquake Retrofitting Decisions*, The Case of Hillside Homes in Los Angeles, Report 2000/03, Pacific Earthquake Engineering Research Center, Berkeley, California.
<https://peer.berkeley.edu/sites/default/files/0003_d._von_winterfeldt_n._roselund_a._kitsuse.pdf>

Protect: Strengthen Garage in Living-Space-over-Garage Homes

FEMA, 2018, *Vulnerability-Based Seismic Assessment and Retrofit of One- and Two-Family Dwellings*, FEMA P-1100, Volume 1, Chapter 6, and Volume 2B, prepared by the Applied Technology Council for the Federal Emergency Management Agency, Washington, D.C.
<<https://www.fema.gov/media-library/assets/documents/175158>>

ICC, 2018 *International Residential Code*, Section R602.10.6.2 and R602.10.6.3, International Code Council, Washington, D.C.

Protect: Strengthen Homes with Unreinforced Masonry Walls

CEA, 2020, *Earthquake Damage Assessment and Repair Guidelines for Residential Wood-Frame Buildings*, Volume 1 – General, CEA-EDA-01 (ATC-143), prepared by the Applied Technology Council for the California Earthquake Authority, Sacramento, California.

FEMA, 2006, *Techniques for the Seismic Rehabilitation of Existing Buildings*, Chapter 21, 2006 Edition, FEMA 547, Federal Emergency Management Agency, Washington, D.C.
<<https://www.fema.gov/media-library/assets/documents/8564>>

FEMA, 2009, *Unreinforced Masonry Buildings and Earthquakes, Developing Successful Risk Reduction Programs*, FEMA P-774, Federal Emergency Management Agency, Washington, D.C.
<<https://www.fema.gov/media-library/assets/documents/18030>>

ICC, 2018, *International Building Code*, Chapter A1, International Code Council, Washington, D.C.

USSC, 2016, *The Utah Guide for the Seismic Improvement of Unreinforced Masonry Dwellings*, 2nd Edition, Utah Seismic Safety Commission, Salt Lake City, Utah.
<<https://ussc.utah.gov/pages/view.php?ref=1281>>

Protect: Retrofit Masonry Chimneys

FEMA, 2015, *South Napa Earthquake Recovery Advisory*, Repair of Earthquake-Damaged Masonry Fire Place Chimneys, FEMA DR-4193-RA1, prepared by the Applied Technology Council for the Federal Emergency Management Agency, Washington, D.C.
<<https://www.fema.gov/media-library/assets/documents/103966>>

FEMA, 2018, *Vulnerability-Based Seismic Assessment and Retrofit of One- and Two-Family Dwellings*, FEMA P-1100, Volume 1, Chapter 6, and Volume 2C, prepared by the Applied Technology Council for the Federal Emergency Management Agency, Washington, D.C.

ICC, 2018 International Residential Code, Chapter 10, *International Code Council*, Washington, D.C.

Survive

American Red Cross, *Disaster Preparedness Plan*, American Red Cross, Washington, D.C.
<<https://www.redcross.org/get-help/how-to-prepare-for-emergencies/make-a-plan.html>>

American Red Cross, *Safe and Well*, American Red Cross, Washington, D.C.
<<https://safeandwell.communityos.org/cms/index.php>>

CEA, *Personal Preparedness – How to be Prepared for an Earthquake*, California Earthquake Authority, Sacramento, California.
<<https://www.earthquakeauthority.com/California-Earthquake-Risk/Personal-Preparedness>>

CUSEC, *Earthquake Safety and Preparedness*, Central United States Earthquake Consortium, Memphis, Tennessee. <<https://cusec.org/>>

ECA, *The Seven Steps to Earthquake Safety*, Earthquake Country Alliance, Los Angeles, California.
<<https://www.earthquakecountry.org/sevensteps/>>

ECA, *Protect Yourself*, Earthquake Country Alliance, Los Angeles, California.
<<https://www.earthquakecountry.org/disability/>>

FEMA, 2017, *Protect Yourself During Earthquakes*, FEMA P-1078, Federal Emergency Management Agency, Washington, D.C.
<<https://www.fema.gov/media-library/assets/documents/123936>>

FEMA, *Earthquake Safety at Home*, Federal Emergency Management Agency, Washington, D.C.
<<https://www.fema.gov/earthquake-safety-home>>

USGS, 2011, *Putting Down Roots in Earthquake Country - Your Handbook for the Central United States*, General Information Product 119, United States Geological Survey, Reston, Virginia.
<<https://pubs.er.usgs.gov/publication/gip119>>

Respond

ATC, 2005, *Field Manual: Postearthquake Safety Evaluation of Buildings*, ATC-20-1 Second Edition, Applied Technology Council, Redwood City, California.
<<https://www.atccouncil.org/atc-20>>

USGS, 2011, *Putting Down Roots in Earthquake Country - Your Handbook for the Central United States*, General Information Product 119, United States Geological Survey, Reston, Virginia.
<<https://pubs.er.usgs.gov/publication/gip119>>

FEMA, 2017, *Earthquake Safety Checklist*, FEMA B-526, Federal Emergency Management Agency, Washington, D.C.
<<https://www.fema.gov/media-library/assets/documents/3234>>

FEMA, *Earthquake Safety at Home*, Federal Emergency Management Agency, Washington, D.C.
<<https://www.fema.gov/earthquake-safety-home>>

Recover and Repair

CEA, 2020, *Earthquake Damage Assessment and Repair Guidelines for Residential Wood-Frame Buildings*, Volume 1 – General, CEA-EDA-01 (ATC-143), prepared by the Applied Technology Council for the California Earthquake Authority, Sacramento, California.

FTC, *Hiring a Contractor*, Federal Trade Commission Consumer Information, Washington, D.C.
<<https://www.consumer.ftc.gov/articles/0242-hiring-contractor>>

FEMA, 2004, *Helping Children Cope with Disaster*, FEMA-478, Federal Emergency Management Agency, Washington, D.C.
<<https://www.fema.gov/pdf/library/children.pdf>>

FEMA, *Hazard Mitigation Assistance*, Federal Emergency Management Agency, Washington, D.C.
<<https://www.fema.gov/hazard-mitigation-assistance>>

SBA, *Disaster Assistance*, United States Small Business Administration, Washington, D.C.
<<https://www.sba.gov/funding-programs/disaster-assistance>>

Supplement: Earthquake Across America

Heaton, T., and Kanamori, H., 1984, “Seismic potential associated with subduction in the Northwestern United States,” *Bulletin of the Seismological Society of America*, GeoScienceWorld, 1.

USGS, 2011, *Putting Down Roots in Earthquake Country-Your Handbook for the Central United States*, General Information Product 119, United States Geological Survey, Reston, Virginia.
<<https://pubs.er.usgs.gov/publication/gip119>>

This page intentionally left blank.



FEMA

FEMA P-530