



# Mac Pro

## Technology Overview

August 2021



# Contents

Introduction .....	3
Product Overview .....	4
Key Features .....	4
Architecture .....	8
Intel Xeon W .....	8
Memory .....	9
PCI Express Expansion.....	9
Graphics .....	12
High-Performance I/O .....	18
Apple T2 Security Chip.....	19
Internal SSD .....	20
Power Supply .....	20
Enclosure.....	21
Afterburner .....	23
Pro Display XDR.....	25
Key Features .....	25
macOS Big Sur .....	27
Performance .....	29
Processor Performance.....	29
Graphics Performance.....	31
Configuring Mac Pro .....	32
Enclosure Considerations .....	32
Processor Considerations .....	32
Memory Considerations.....	33
Graphics Considerations.....	34
Display Considerations .....	35
Expansion Considerations .....	35
Example Configurations.....	36
Product Details .....	38
Configuration Options.....	38
Related Apple Products .....	39
Related Third-Party Products .....	39
AppleCare+ for Mac Pro.....	39
AppleCare for Enterprise.....	40
Technical Specifications.....	41
Hardware .....	41
Software.....	44

# Introduction



Mac Pro was developed with a singular purpose: to enable professionals to do their most demanding work without constraint. It's designed and engineered to enable a wide range of different uses, and presents virtually unlimited possibilities for customization and expansion.

Built with a high-performance architecture, Mac Pro pushes the boundaries of capability in every dimension. Up to 28-core processors. Up to 1.5TB of memory. Up to four GPUs with over 60 teraflops of compute and 128GB memory. Up to 8TB of superfast SSD. Eight PCI Express expansion slots, dual 10Gb Ethernet, and up to 12 Thunderbolt 3 ports for massive expansion. And Afterburner, an accelerator card for ProRes that enables Mac Pro to play back up to 6 streams of 8K ProRes RAW.<sup>1</sup>

Mac Pro is engineered to provide unprecedented levels of access and capability. Every aspect of the hardware is designed to be flexible and accommodate change. The graphics, storage, and memory modules are easily expandable and configurable. The tower enclosure has feet to get the system up off the floor, or can be configured with optional wheels that make it easy to move Mac Pro across the studio. A rack enclosure option provides flexibility in deployment, and a form factor to fit into a wide array of pro environments.

Mac Pro is designed for pros who need the ultimate in CPU performance. From production rendering to playing hundreds of virtual instruments to simulating an iOS app on multiple devices at once, it's exceedingly capable. At the heart of the system is an Intel Xeon processor with up to 28 cores—the most ever in a Mac. Mac Pro delivers processor performance that's up to 6.5x faster<sup>2</sup> than the previous top-of-the-line 12-core Mac Pro. And for many pros, a high-performance graphics architecture is critical to their workflows, especially for tasks like animating 3D film assets, compositing 8K scenes, and building lifelike gaming environments. Delivering incredible levels of graphics capability with up to four Radeon Pro W6000-Series graphics processors, Mac Pro is up to 11x faster<sup>3</sup> than the dual FirePro D700 graphics in the previous Mac Pro.

The result is a system that brings the elegance of macOS with workstation-class performance, powering pro users to do their life's best work.

Meet Mac Pro.

# Product Overview

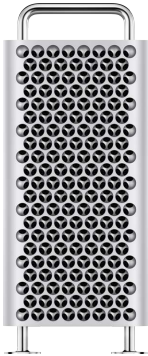

## Mac Pro

Tower workstation

Mac Pro delivers maximum performance, expansion, and configurability.

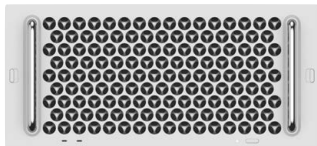

## Mac Pro

Rack workstation

All of the performance, expansion, and configurability of the Mac Pro tower in a rack-optimized 5U enclosure.



## Pro Display XDR

With Retina 6K resolution, gorgeous color, and extreme brightness and contrast ratio, Pro Display XDR is the world's best pro display.

## Key Features

Mac Pro is the most powerful Mac ever built. With the most performance, expansion, and configurability yet, it is a system created to let a wide range of professionals push the limits of what is possible.

**Enclosure.** The Mac Pro enclosure design is a whole new take on the tower workstation. Architected for performance, modularity, accessibility, and upgradability, Mac Pro is built around a stainless steel space frame with an aluminum housing that easily lifts off. The frame features rounded handles on the top, making it easy to pick up and move, and the bottom features feet or optional casters for enhanced mobility. The interior components attach to the frame and when it's open, you have 360° access to the entire system for configuration.

In addition to the tower enclosure, Mac Pro is available in an enclosure optimized for rack deployment. Delivering all of the performance and expansion features of the tower as a rack-mounted workstation, the rack enclosure offers top and bottom panel access to key components, front panel-mounted handles and I/O, and quick deployment rails for easy installation.

**Up to 28-core Intel Xeon W processor.** Mac Pro is designed to tackle the most demanding pro workloads. To enable that, Mac Pro starts with a powerful Intel Xeon workstation-optimized processor that's configurable from 8 to 28 cores for scalable performance. All Mac Pro processors feature Turbo Boost, Hyper-Threading, large L2 and shared L3 caches, AVX-512 vector instructions, and 64 PCI Express lanes for massive bandwidth in and out of the processor.

**Up to 1.5TB of DDR4 ECC memory.** Featuring a six-channel memory architecture, fast 2933MHz DDR4 ECC memory, and configurability up to 1.5TB,<sup>4</sup> Mac Pro can handle the largest tasks. Twelve physical DIMM slots enable massive memory capacities as well as the ability to easily upgrade memory capacity over time using industry-standard DIMMs.

**Eight PCI Express expansion slots.** With eight internal PCI Express slots, Mac Pro can be highly configured. Four full-length 16-lane (x16) PCI Express expansion slots, three 8-lane (x8) slots, and a half-length x4 slot that come preconfigured with the Apple I/O card provide flexible internal expansion for storage, video I/O, and other high-bandwidth cards.

**MPX Module.** To deliver the highest-possible graphics performance and provide seamless integration into the system, Mac Pro features the Mac Pro Expansion Module, or MPX Module. MPX Modules provide a larger form factor, more power, and cableless integration into Mac Pro.

**Graphics.** Mac Pro provides the highest-performance, most flexible graphics options of any Mac. Offering multiple graphics options including the Radeon Pro 580X and Radeon Pro W5700X, Mac Pro features workstation-class Radeon Pro W6000-Series graphics processors with up to 22.2 teraflops of compute performance, 32GB of memory, 512GB/s of memory bandwidth, and the Infinity Fabric Link interconnect. For more power, two W6000-Series GPUs combine to create the Radeon Pro W6800X Duo MPX Module, providing two powerful GPUs on a single module with 30.2 teraflops of compute performance and 64GB of graphics memory.

**Afterburner.** Created to transform the workflow for film and video professionals, Afterburner is a hardware accelerator card built with an FPGA, a programmable logic chip. With over a million system logic cells, it can process up to 6.3 billion pixels per second. When installed in Mac Pro, the system is a multistream video processing powerhouse, capable of decoding up to 6 streams of 8K ProRes RAW, 16 streams of 4K ProRes, or 23 streams of 4K ProRes RAW.<sup>1</sup>

**Dual 10Gb Ethernet and up to 12 Thunderbolt 3 ports.** Mac Pro has four Thunderbolt 3 ports, two USB-A ports, and two 10Gb Ethernet ports standard for high-performance I/O. And many MPX Modules provide additional Thunderbolt ports on their own independent PCIe lanes, enabling up to 12 Thunderbolt 3 ports in Mac Pro. Connect up to 12 4K displays or up to six Apple Pro Display XDRs and see your work with over 120 million pixels.

**Apple T2 Security Chip.** Mac Pro is the most secure tower we've ever built. A Secure Enclave coprocessor in T2 provides the foundation for encrypted storage and secure boot capabilities. Data on the internal Mac Pro SSD is protected by the dedicated AES encryption engine in the Apple T2 Security Chip while delivering 3.4GB/s sequential read and write performance.<sup>5</sup> Secure boot ensures that the lowest levels of software aren't tampered with and that only operating system software trusted by Apple loads at startup.

**macOS Big Sur.** macOS Big Sur brings a refined design, powerful controls, and intuitive customization options to the most advanced desktop operating system in the world.

Pro users love the power, reliability, and productivity built into macOS—designed to take full advantage of Mac hardware, deliver robust features with the highest-possible performance, and work seamlessly with other Apple devices. Dark Mode highlights pro content while controls recede into the background on the stunning Retina display. Sidecar lets users leverage iPad as a second display or as a high-precision tablet input device using Apple Pencil.<sup>6</sup> Files on macOS can be quickly browsed, and get easy access to metadata with Gallery View in Finder. Along with a robust ecosystem of third-party apps and devices, macOS includes Apple apps like Safari, Mail, Pages, Numbers, and Keynote, and supports high-performance apps like Final Cut Pro, Logic Pro, and Xcode.

## Mac Pro Tower Workstation

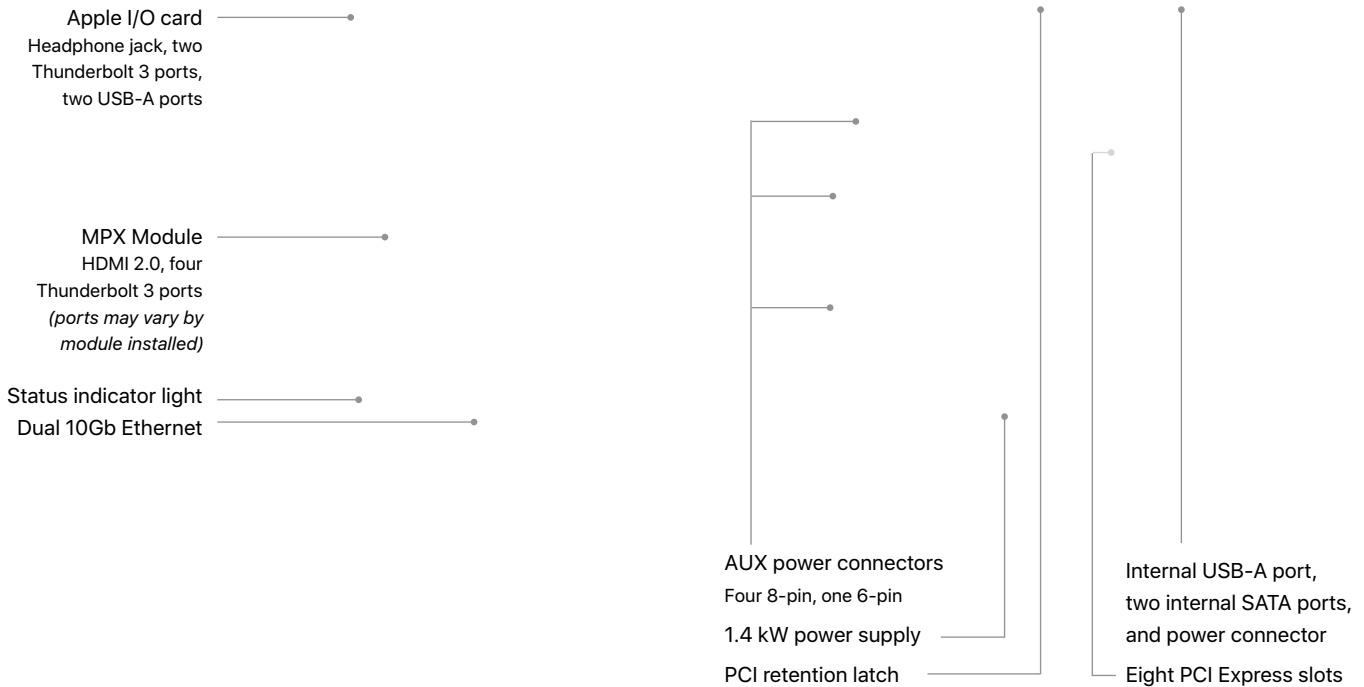
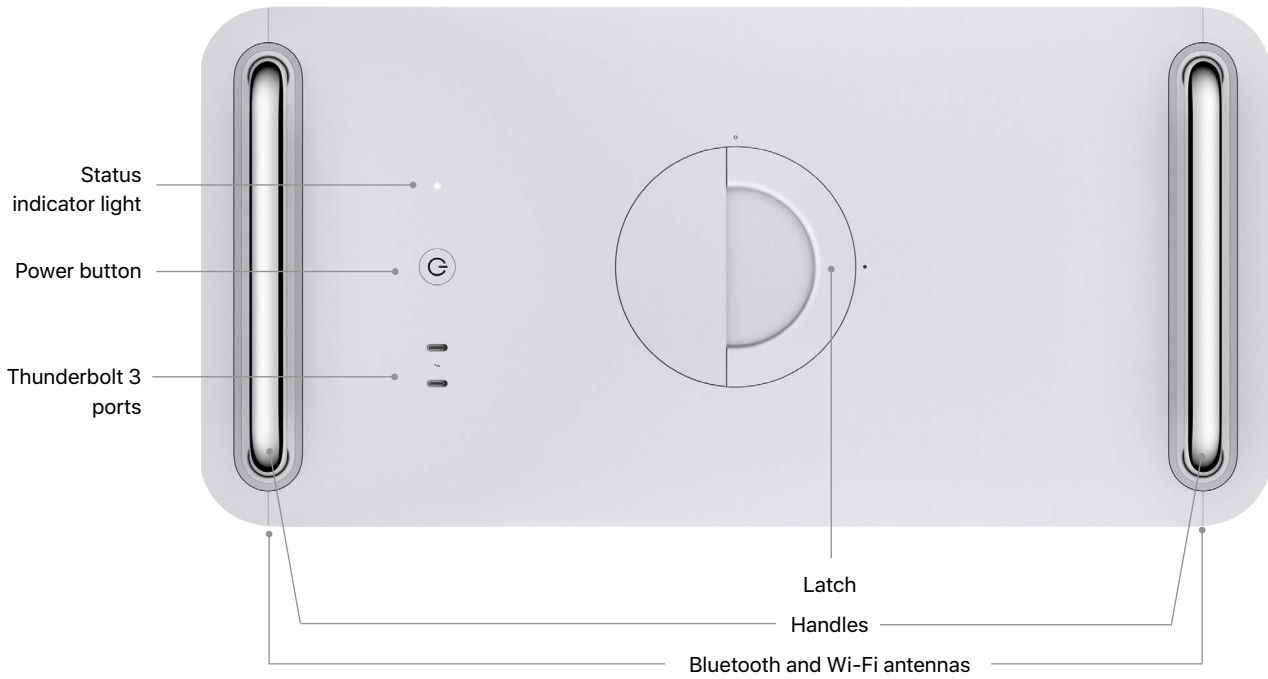

# Mac Pro Rack Workstation

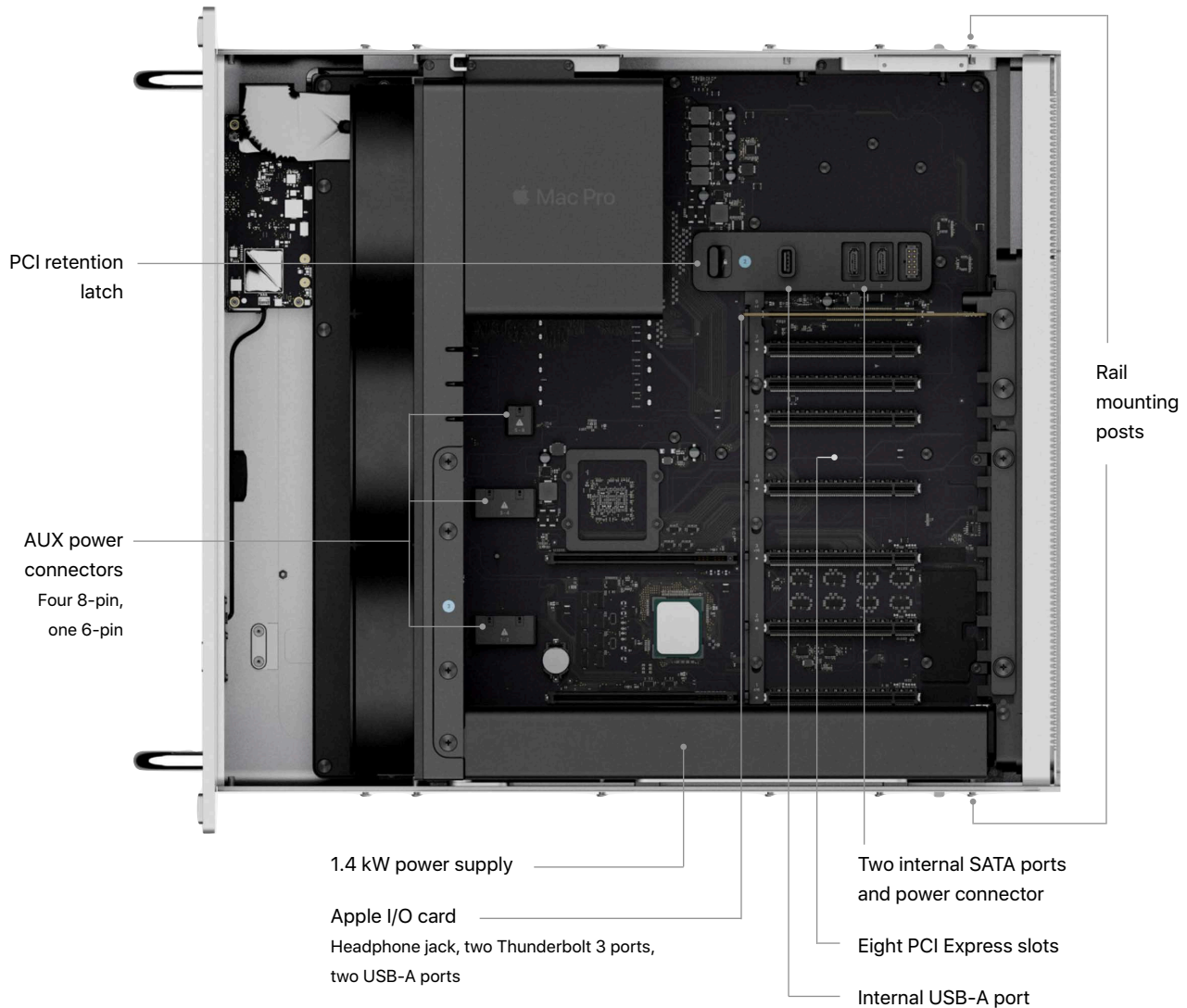
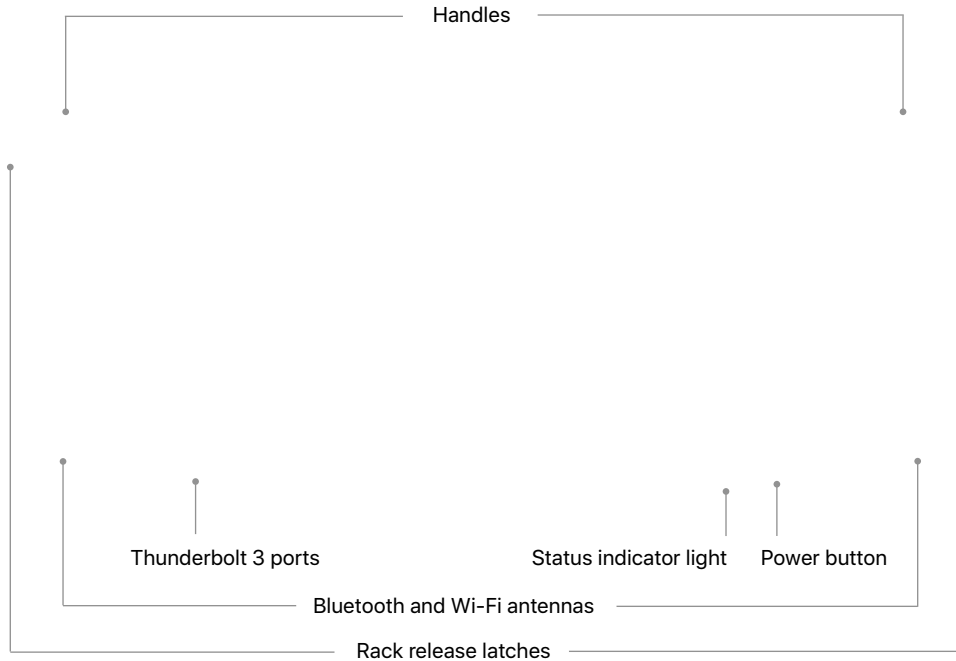

# Architecture

Every aspect of Mac Pro is designed in pursuit of performance. Built to push the limits for demanding creative workflows, its architecture balances performance and capabilities across processor, graphics, memory, I/O, and storage subsystems.



## Intel Xeon W

Optimized for workstation performance, the Intel Xeon W-3200 series processors in Mac Pro offer 8-, 12-, 16-, 24-, and 28-core processing with up to 60MB of cache (L2 plus shared L3), up to 4.4GHz Turbo Boost performance, and 64 PCI Express lanes for I/O.

## Intel Xeon W

Mac Pro is designed to tackle the most demanding pro workloads. The foundation of workstation performance is a high-performance processor. Mac Pro starts with a workstation-optimized Intel Xeon processor that's configurable with 8, 12, 16, 24, or 28 cores for scalable performance. Xeon W processors feature Turbo Boost, Hyper-Threading, large L2 and shared L3 caches (1MB L2 cache per core plus 1.375MB shared L3 cache per core), six DDR4 memory channels, and dual AVX-512 vector units with FMA (fused multiply add) support. A high-bandwidth mesh architecture internally connects processor cores to memory and I/O on the processor.

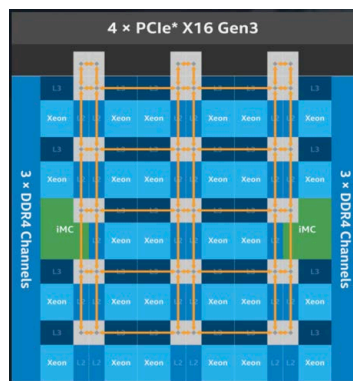

Workstations require high-bandwidth connectivity to compute, graphics, and storage resources inside the system. This generation of Intel Xeon W features 64 PCI Express lanes for massive bandwidth in and out of the processor.

To maximize processor performance, Mac Pro couples these powerful processors with an advanced thermal architecture featuring a massive heat sink. While the Intel Xeon W processors are rated at up to 205W TDP (thermal design power), Mac Pro provides over 300W of processor cooling, allowing the processor to maximize Turbo Boost performance during sustained workloads.





### Up to 1.5TB of DDR4 ECC SDRAM

Mac Pro is offered with memory configurations up to 768GB (6x128GB or 12x64GB) on 8-, 12-, and 16-core processors and up to 1.5TB (12x128GB) on 24- and 28-core processors. These configurations maximize the memory bandwidth of the six-channel memory controller. The processors are rated by Intel to support up to 1TB or 2TB respectively; however, configuring these capacities would require populating the system in an unbalanced DIMM configuration. Populating Mac Pro with six or twelve DIMMs of the same size, type, and speed is recommended for maximum performance.

## Memory

A powerful multicore workstation processor needs plenty of high-bandwidth memory to feed it. The Intel Xeon W in Mac Pro features a six-channel memory architecture featuring 2933MHz DDR4 ECC memory delivering up to 140GB/s.

Twelve physical DIMM slots, two DIMMs per channel, located on the back side of the main logic board (MLB) provide easy access and simple upgrades. 8-, 12-, and 16-core processors support up to 768GB of memory using industry-standard DDR4 ECC DIMMs; the 24- and 28-core processors support up to 1.5TB of memory using twelve 128GB LR-DIMMs. The 8-core Xeon runs memory at 2666MHz (PC4-19200); all other processors operate at 2933MHz (PC4-23466).

Mac Pro configurations start with 32GB of memory using four 8GB DIMMs, therefore utilizing four memory channels. For maximum memory performance, six or twelve DIMMs, fully utilizing each channel, should be configured. Mac Pro supports both R-DIMMs (registered DIMMs) and LR-DIMMs (load-reduced DIMMs), but R-DIMMs and LR-DIMMs cannot be installed in the system at the same time; all DIMMs in the system must be of the same type.

The 24- and 28-core processors support a massive 1.5TB of physical memory that is enabled by twelve installed 128GB LR-DIMMs. This 128GB DIMM utilizes 3D stacked DRAM to achieve high memory density. 3D stacked memory increases memory latency by a small amount, slightly reducing overall memory bandwidth by up to 10 percent. Applications that benefit from very large amounts of memory typically benefit most significantly by the physical capacity, eliminating the performance impact of using virtual memory—with even higher increases in memory latency due to swapping to disk. Applications not needing that amount of physical memory are better served using lower-capacity DIMMs without the increase in memory latency, and therefore higher effective memory bandwidth.

## PCI Express Expansion

Mac Pro supports high-bandwidth internal expansion with eight PCI Express gen 3 slots. Four full-length 16-lane (x16) PCI Express expansion slots, three 8-lane (x8) slots, and a half-length x4 slot that comes preconfigured with the Apple I/O card provide flexibility for storage, video I/O, audio DSP, and other high-bandwidth cards. Slots 1 and 3 are directly connected to dedicated x16 root ports on the Xeon processor; all other slots are connected through a high-performance PCI Express switch fabric.

### PCI Express Slots

Eight PCI Express slots are enabled by the 64 PCI Express lanes provided by the Intel Xeon processor and a high-performance PCI Express switch fabric on the main logic board that includes a 96-lane PCI Express switch.

Slots 1, 3, 4, and 5 are x16 wide; slots 2, 6, and 7 are x8 wide; slot 8 is x4 wide.

Slots 1 through 7 support full-length PCI Express cards. Slots 1 through 4 provide double-wide spacing for cards like third-party graphics cards. Slots 5 through 7 are single-wide slots. Slot 8, which comes pre-populated by the Apple I/O card, is a half-length slot. Mac Pro supports operation without the Apple I/O card and that slot can be configured with other half-length PCI Express devices.

Slots 1 through 4 also provide physical space and connectivity for the two MPX bays in Mac Pro. When an MPX Module is installed in bay 1 (slots 1 and 2), slot 2 is disabled and its PCIe lanes are routed to the MPX connector in bay 1. When an MPX Module is installed in bay 2 (slots 3 and 4), slot 4 is disabled and its PCIe lanes are routed to the MPX connector in bay 2.

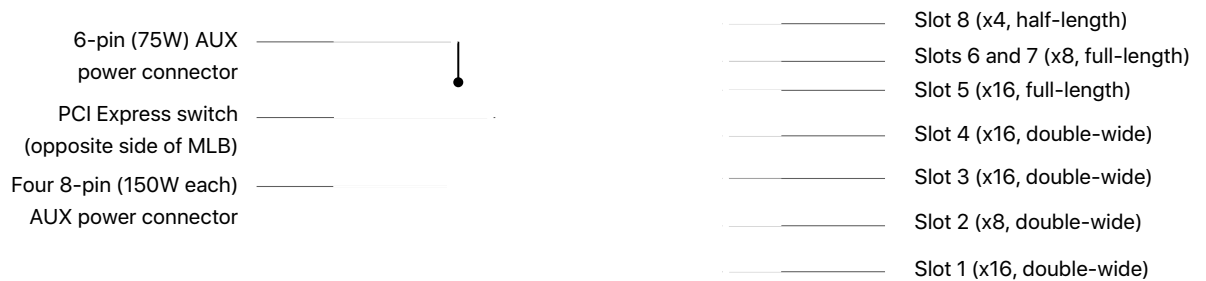

Mac Pro provides four 8-pin auxiliary (AUX) power connectors that each provide 150W of power, for a total of 600W of AUX power. This power is in addition to the 75W of power provided directly by each PCIe slot. Combined, up to four 225W graphics cards can be installed in Mac Pro, each in an x16 slot with a total power of 900W. A single 6-pin AUX power connector provides 75W of additional power for PCIe cards in slots 5, 6, and 7.

Expansion cards are retained in the system with clamping plates and require a standard Phillips-head screwdriver for access. An internal latch engages and disengages the standard PCI Express retention feature, informally known as the “hockey stick,” present on most industry-standard PCI Express cards.

### High-Performance PCI Express Switch Fabric

Mac Pro PCI Express expansion capabilities are enabled by four x16 root ports on the Intel Xeon W processor, providing 64 PCI Express lanes and a high-performance PCI Express switch fabric. All PCI Express slots and Thunderbolt controllers connect either directly or through this PCIe fabric.

PCIe slots 1 and 3, the primary MPX Module slots, each connect directly to an x16 root port on the Xeon processor. This provides maximum bandwidth to the two MPX Module bays, ideal for graphics performance.

The remaining PCIe slots and Thunderbolt controllers connect through the PCI Express switch fabric to the two remaining x16 root ports on the Xeon processor. This fabric is configurable through the Expansion Slot Utility, allowing high-bandwidth PCIe devices (such as Afterburner or a Fibre Channel card) to be configured on either of the two root ports. Expansion Slot Utility can be accessed through "About this Mac" under the PCI Cards tab.

The default setting for the system is for automatic bandwidth configuration and in most cases this setting can be left as configured.

**Expansion Slot Utility** showing two MPX Modules installed, represented by the gray boxes, and the default Automatic Bandwidth Configuration selected.

In cases where you want to override the default behavior, Automatic Bandwidth Configuration can be disabled and slots mapped to either x16 root port (designated A and B in the utility).

Note that all Thunderbolt ports in the systems are fixed to use root port B.

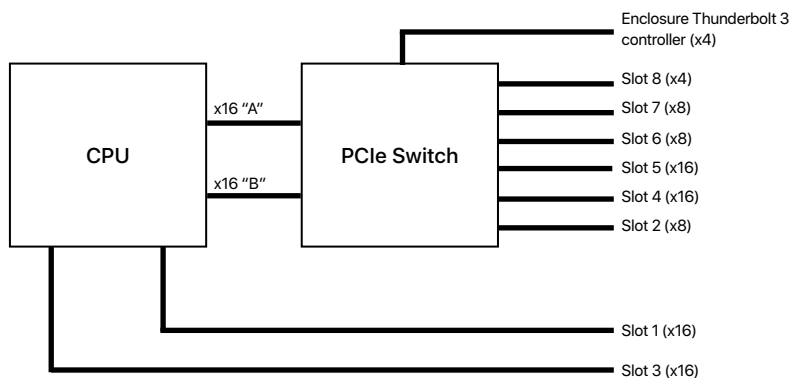

**Mac Pro PCI Express lane configuration.** (DMI connection to Intel PCH and Apple T2 Security Chip not shown.)

## Graphics

Pro workloads increasingly depend heavily on the graphics processor for getting work done. Mac Pro offers several workstation-class graphics options with a range of performance and capabilities, providing flexibility and upgradability to address a range of pro requirements.

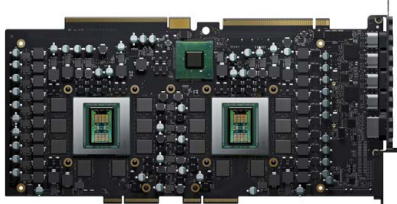

### MPX Module

Traditional desktop GPU cards bring modularity and upgradability to a system, but trade-off features like Thunderbolt support and require managing power cables, PCIe bandwidth, and overall system power. Today's modern GPUs demand more power and more cooling: double-wide full-length cards with massive thermal systems, multiple display outputs to drive 4K and higher displays, and auxiliary (AUX) power connections to provide 300W or more of power.

Mac Pro was architected for multiple modular GPUs to enable configurability and upgradability. But the typical industry-standard double-wide GPU card has many challenges. First, the thermal systems, especially on-card fans, weren't designed as part of the overall system thermal architecture. They are often loud and not well-managed. In multi-GPU systems, the fans can actually compete with each other for airflow, impacting performance. Second, the AUX power requirements make GPU cards more complicated to install. Third, they don't enable Thunderbolt, either on-card or in the system. So Thunderbolt isn't native on the card (and if it were, it would steal from the GPU PCIe bandwidth), and there is not a good solution to route DisplayPort video from the GPU into the Thunderbolt controllers without additional cables and complexity.

Apple set out to address these issues by designing a better solution for modular GPU integration—the Mac Pro Expansion Module, or MPX Module. The design had four simple goals: enable maximum performance; enable Thunderbolt on the GPU module; enable easy, cable-free installation; and enable backward compatibility with industry-standard PCI Express cards.

First, the MPX Module design starts with the industry-standard GPU slot, PCI Express x16, so it maintains compatibility with standard cards.

Second, the introduction of a secondary card-edge connector provides additional independent PCIe bandwidth (x8 PCIe lanes) for Thunderbolt, routing for DisplayPort video to the main logic board, control signals for management, and a massive 475W of additional power on top of the 75W per PCIe x16 slot already provided.

Third, it has a larger form factor. Bigger in X, Y, and Z, the quad-high PCIe slot MPX Module provides space for a larger passive heat sink that can be cooled efficiently as part of the larger thermal system in Mac Pro. This allows Mac Pro to operate quietly even under heavy load. The larger size also enables other solutions, such as dual GPU modules and RAID storage modules.



### Promise Pegasus R4i MPX Module

A unique RAID storage MPX Module, the [Promise Pegasus R4i](#) provides the performance, reliability, and capacity of a Pegasus3 R4 as an internal MPX Module. Offering 32TB (four 8TB HDDs) of raw capacity, Pegasus R4i supports RAID 0, 1, 5, 6, and 10 using the proven Pegasus RAID engine.

Finally, MPX Modules enable seamless Thunderbolt integration. Mac Pro full-size MPX Modules have two independent Thunderbolt 3 controllers with four Thunderbolt 3 ports on the card. The Thunderbolt controllers get their PCIe bandwidth from the extra x8 PCIe lanes to the module, so are completely independent from the graphics processor bandwidth. The full-size modules also route DisplayPort connections to the main logic board to provide video to the system’s built-in Thunderbolt ports, which are enabled on a first-come, first-served basis. The half-size module provides two HDMI 2 ports on the card and routes four DisplayPort connections to the main logic board to fully enable all four built-in Thunderbolt 3 ports.

Mac Pro has system support for two MPX bays, enabling two GPU modules in the system for up to 1000W of graphics power. When a half-size MPX Module is installed, an extra double-wide PCIe slot becomes available—with x8 bandwidth in the lower MPX bay, and x16 bandwidth in the upper MPX bay. Further, because MPX Modules are based on the industry-standard PCI Express, off-the-shelf graphics cards can be installed as well. Each MPX bay can support two double-wide cards and up to 300W of AUX power via two 8-pin connectors on the MLB.

Mac Pro will offer a range of GPU performance for pro customers.

### Radeon Pro 580X MPX Module

The Radeon Pro 580X MPX Module is the entry graphics card for Mac Pro, perfect for non-GPU-intensive applications like audio, software development, or compute-oriented tasks where maximum graphics performance isn’t required.



The AMD Radeon Pro 580X features 8GB of GDDR5 memory and delivers up to 5.6 teraflops of FP32 compute performance. It provides two HDMI 2 ports on the back of the card and routes four DisplayPort connections to the Mac Pro internal Thunderbolt controllers to enable display connectivity through the enclosure Thunderbolt 3 ports. The Radeon Pro 580X can drive two Pro Display XDR displays, two 5K displays, or four 4K displays plus two displays via HDMI 2.0.

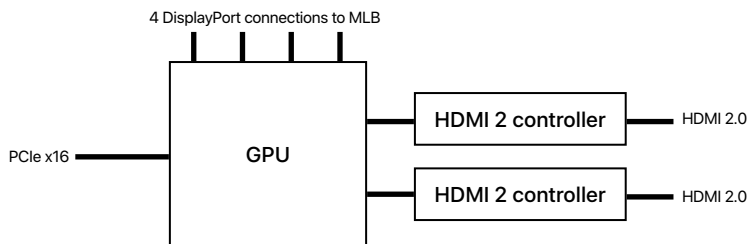

### Radeon Pro 580X MPX Module architecture

The Radeon Pro 580X is a half-height MPX Module. When installed, it makes available an extra PCIe expansion slot for additional expansion.



**Radeon Pro 580X**

When a half-height MPX Module is installed, an additional double-wide PCIe slot (slot 2) is available, enabling six available PCIe slots in Mac Pro plus the Apple I/O card in slot 8.

**Radeon Pro W5500X MPX Module**

Based on AMD’s RDNA architecture, the AMD Radeon Pro W5500X features 8GB of GDDR6 memory and delivers up to 5.6 teraflops of FP32 compute performance and 11.2 teraflops of FP16 performance. It provides two HDMI 2 ports on the back of the card and routes two DisplayPort connections to the Mac Pro internal Thunderbolt controllers to enable display connectivity through the enclosure Thunderbolt 3 ports. The Radeon Pro W5500X can drive one Pro Display XDR, one 5K display, or two 4K displays over Thunderbolt plus two displays directly connected via HDMI 2.0.

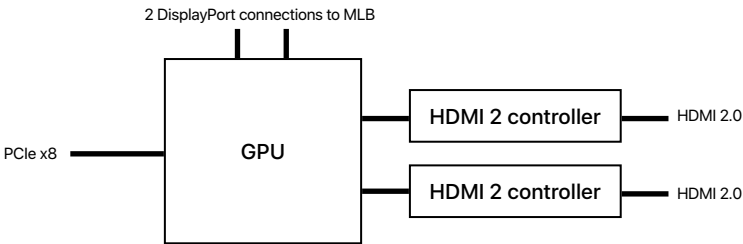

**Radeon Pro W5500X MPX Module architecture**

The Radeon Pro W5500X is a half-height MPX Module. When installed, it makes available an extra PCIe expansion slot for additional expansion.



### Radeon Pro W5700X MPX Module

The Radeon Pro W5700 MPX Module is a midrange card for Mac Pro. Based on AMD’s RDNA architecture, this 7nm GPU features compute units with enhanced performance-per-clock, a GDDR6-based memory controller, and support for DisplayPort Display Stream Compression (DSC).

The AMD Radeon Pro W5700X features 16GB of GDDR6 memory with 448GB/s of memory bandwidth and delivers up to 9.4 teraflops of single-precision (FP32) and 18.9 teraflops of half-precision (FP16) compute performance. It provides four Thunderbolt 3 ports on two independent controllers as well as an HDMI 2 port on the back of the card. It also routes two DisplayPort connections to the Mac Pro internal Thunderbolt controllers to enable display connectivity through those ports. The Radeon Pro W5700X can drive up to three Pro Display XDR displays, three 5K displays, or six 4K displays. When used with Pro Display XDR, DSC is enabled, allowing the downstream USB-C ports in the display to provide USB 3.0 (5Gb/s) bandwidth.

The Radeon Pro W5700X is a full-height MPX Module.

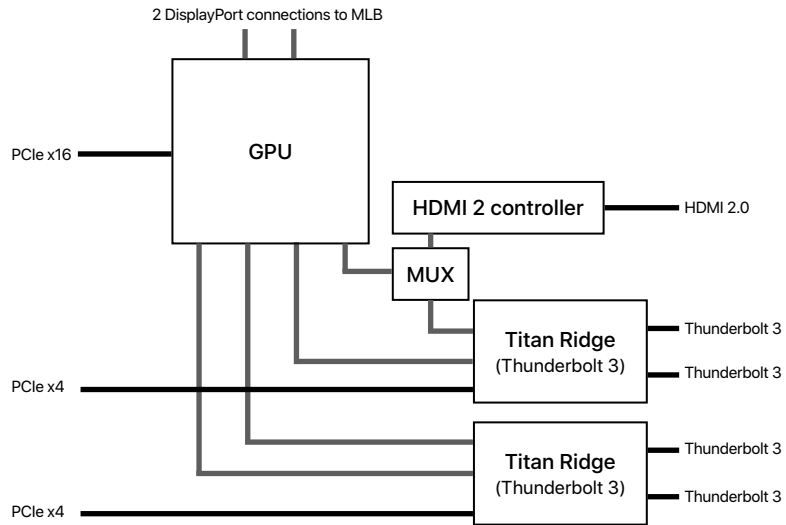

Radeon Pro W5700X MPX Module architecture



### Radeon Pro W6800X and W6900X MPX Modules

The Radeon Pro W6800X and W6900X MPX Modules deliver workstation-class graphics ideal for demanding pro applications. Based on AMD’s RDNA2 architecture, these 7nm GPUs feature compute units with 50 percent improved performance-per-watt, a GDDR6-based memory controller, and support for DisplayPort Display Stream Compression (DSC). Install two in your Mac Pro and connect them with Infinity Fabric Link for applications that utilize this link for enhanced multi-GPU performance.

The AMD Radeon Pro W6000-Series GPUs feature 32GB of GDDR6 memory. With 60 compute units, the W6800X delivers up to 16.0 teraflops of FP32 and 32.0 teraflops of FP16 compute performance; the W6900X has 80 computer units and delivers up to 22.2 teraflops of FP32 and 44.4 teraflops of FP16 performance. Both provide four Thunderbolt 3 ports on two independent controllers as well as an HDMI 2 port on the card. These cards also route two DisplayPort connections to the Mac Pro internal Thunderbolt controllers to enable display connectivity through those ports. The Radeon Pro W6800X and W6900X can drive three Pro Display XDR displays, three 5K displays, or six 4K displays.

The Infinity Fabric Link connection enables two identical W6000-Series MPX Modules to connect at over 80GB/s—five times the bandwidth of the PCIe x16 gen 3 connection. This connection is installed in the factory when two W6000-Series MPX Modules are configured, and comes with the Radeon Pro W6800X or W6900X MPX Module when purchased separately.

Two W6800X or W6900X MPX Modules with Infinity Fabric Link serve as an ideal high-performance configuration for video applications like Final Cut Pro, as each GPU gets dedicated PCIe x16 bandwidth for video data transfer from CPU while Infinity Fabric Link enables optimized multi-GPU data transfer.

The Radeon Pro W6800X and W6900X are full-height MPX Modules.

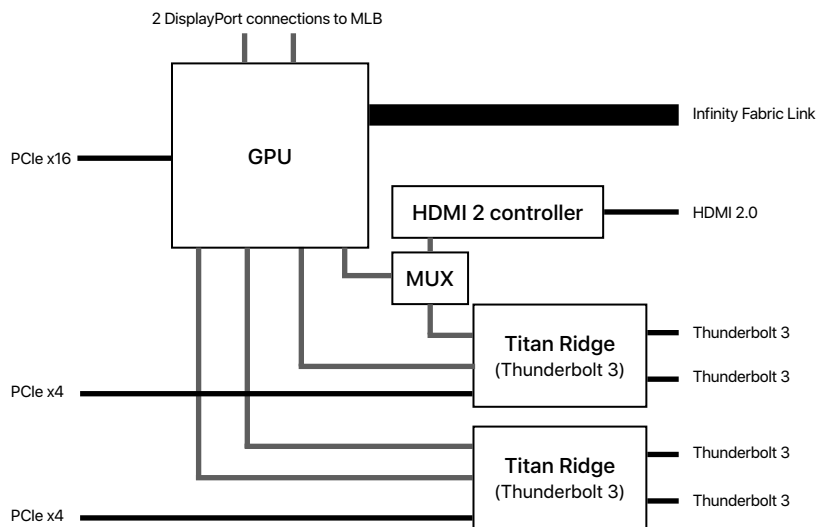

**Radeon Pro W6800X and W6900X MPX Module architecture**





## High-Performance I/O

Mac Pro features Thunderbolt 3 ports for versatile high-performance connectivity and 10Gb Ethernet for LAN and NAS connectivity in pro environments. In addition, an internal USB 3 port and two SATA ports provide internal connectivity for third-party accessories.

### Apple I/O Card

Mac Pro comes with an Apple I/O card preinstalled in slot 8 and features a headphone jack, two USB 3 (5Gb/s) ports, and two Thunderbolt 3 ports. It has a special connector that connects it to the DisplayPort connections routed from the MPX Modules, enabling video over its Thunderbolt 3 ports. When removed, slot 8 can be used as a half-length, full-height PCIe x4 slot.

### Thunderbolt 3 Enclosure I/O

In addition to the two Thunderbolt 3 ports on the Apple I/O card, Mac Pro provides two enclosure I/O ports, either on the top (tower enclosure) or the front (rack enclosure). Thunderbolt 3 (USB-C) ports provide 40Gb/s bandwidth and up to 15W of power for connectivity to displays and devices. Thunderbolt 3 ports support high-performance external devices such as RAID, SSDs, and 10Gb/s USB 3 devices, and also provide connectivity to Thunderbolt 2, USB-A, DVI, VGA, and HDMI devices using optional adapters—so you can continue to use your existing devices, displays, and accessories.

### Dual 10Gb Ethernet

Mac Pro provides dual 10Gb Ethernet built in, enabled by two independent Ethernet controllers. Supporting the NBASE-T industry standard, these RJ45 Ethernet ports auto-negotiate the best speed possible—1Gb, 2.5Gb, 5Gb, or 10Gb/s—based on the cable type and length, and the switch you are connecting to. 10Gb Ethernet allows you to move data up to 10 times faster and connect to high-performance networks and NAS storage devices.



**USB 3 and two SATA ports provide internal connectivity for third-party accessories.**



### Promise Pegasus J2i

Designed to provide internal SATA-based JBOD storage internal to Mac Pro, the [Promise Pegasus J2i](#) provides one or two 3.5-inch 7200-rpm SATA drives on a custom mounting bracket and cable to connect to the internal SATA ports on Mac Pro.



### Apple T2 Security Chip

The Apple T2 Security Chip, our second-generation custom Mac silicon, brings industry-leading security to Mac. For detailed information about hardware security, including secure boot and storage encryption, review the [Apple Platform Security](#) guide.

## Internal USB 3 port

Mac Pro has an internal USB 3 port (5Gb/s USB-A) for internal use. Designed to enable license keys for pro software, this port allows these resources to be secured inside the system.

## Internal SATA ports

Mac Pro provides two internal SATA ports plus a power connector to enable third-party internal storage accessories. The top bracket of Mac Pro provides a mounting point for these solutions. The Promise Pegasus J2i is specifically designed for this, connecting to the Mac Pro enclosure with a custom bracket and cable to provide one or two 3.5-inch 7200-rpm SATA drives.

Note that while these accessories can be mounted internally in Mac Pro, from a macOS security policy standpoint, they are treated like external drives. While they can be encrypted with FileVault software in macOS, they are not encrypted by the Apple T2 Security Chip.

## Apple T2 Security Chip

Mac Pro is architected with the security features and storage performance of the Apple T2 Security Chip. The T2 chip integrates many discrete controllers found in previous Mac systems like the System Management Controller (SMC), audio, and SSD controllers. Its Secure Enclave coprocessor provides foundation for the secure boot and encrypted storage features in Mac Pro. The T2 Security Chip also provides a media engine including a HEVC hardware video encoder.

**Secure Enclave.** The Secure Enclave is a coprocessor fabricated in the Apple T1, T2, and A-series processors. It uses encrypted memory and includes a hardware random number generator. The Secure Enclave provides all cryptographic operations for key management.

**Encrypted storage.** The data on the SSD in Mac Pro is encrypted using dedicated hardware encryption in the T2 chip using keys tied uniquely to each Mac Pro. This provides full disk encryption to all data stored on the SSD, with line-rate performance from a dedicated AES crypto engine in T2 that only your Mac Pro can read. FileVault on Mac Pro extends this encryption to add your personal user key to ensure only your credentials can unlock your data.

**Secure boot.** Mac Pro supports a secure boot process. Starting with the hardware root of trust in the T2 chip, each step of the startup process contains components that are cryptographically signed by Apple to ensure integrity and that proceed only after being cryptographically verified. This includes the boot loaders, firmware, kernel, and kernel extensions. This secure boot chain helps ensure that the lowest levels of software aren't tampered with and that only operating system software trusted by Apple loads at startup.

## Internal SSD

Mac Pro is based on an SSD storage architecture and is configurable from 256GB up to 8TB of internal storage. With the exception of the single-module 256GB SSD, each SSD capacity is implemented through two Apple NAND modules of half the total capacity that are interleaved together to form a single volume. For example, a 4TB SSD is comprised of two 2TB modules and are cryptographically paired to the unique Apple T2 Security Chip in each Mac Pro.

## Power Supply

Mac Pro provides a 1.4 kW power supply capable of delivering 1280W to the system at 108–125V or 220–240V and 1180W at 100–107V. Facility power sources should be carefully considered to avoid overloading a given circuit, especially for a fully configured system with displays and accessories, or multiple Mac Pro systems.

# Enclosure

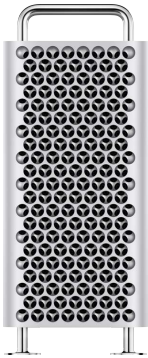

## Lattice Design

The lattice pattern on Mac Pro is based on a naturally occurring phenomenon in molecular crystal structures. To create the structure, a spherical array is machined onto the internal and external surfaces of the aluminum. The result is a lightweight lattice pattern that maximizes airflow while creating an extremely rigid structure.

## Wheels

Optional wheels make Mac Pro easy to move, whether from under your desk or across the studio.

Building a workstation that delivers immense performance and modularity meant considering it as an integrated system. High-performance processors, memory, graphics need to be enabled by an enclosure that provides the power and cooling required for sustained performance as well as access for modularity and upgradability.

The starting point for Mac Pro: The stainless steel space frame accommodates a vast range of components and configurations. The frame is strong, stands on its own, and is ready to be built into a powerful system with endless possibilities. Rounded handles on the top make Mac Pro comfortable to grab, and since directly connected to the space frame, they make the system solid and stable when lifting or moving it. Feet on the bottom keep the system off the floor and optional wheels make it easy to move your Mac Pro, whether from under your desk or across the studio.

A latch on the top of the tower enables the housing to slide off and provides 360° access to the entire system. Paired with a dual-sided logic board that features processor, graphics, and expansion on one side, and storage and memory on the other, everything is directly accessible.

The housing is constructed from aluminum and features a unique lattice pattern that is machined from both sides with an offset to create an incredible three-dimensional vent. Featuring front to back cooling, ideal for both tower and rack design, the lattice pattern also makes the outer structure significantly lighter while maintaining incredible strength. Much more than a decorative shell, the design enables a large two-dimensional open area for a high-airflow, low-impedance design that allows the system to be cooled efficiently while operating very quietly compared to competitive tower workstation systems.

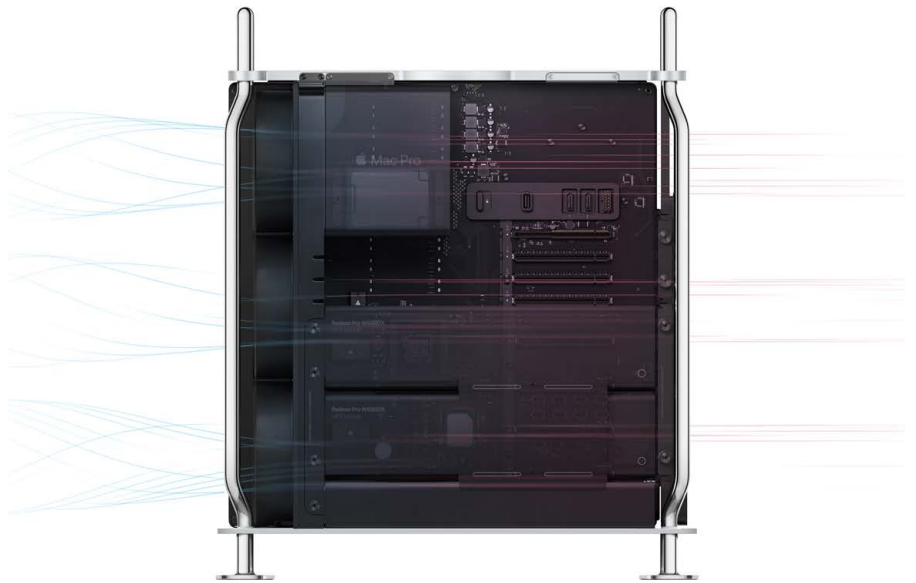

### Tool-less Rack Rails

Designed for rack workstation applications, the rack-optimized Mac Pro enclosure features tool-less rails that support the most common rack sizes and depths. The rails mount without tools in square-hole racks; threaded racks are supported as well. Mac Pro can be accessed while in the rack by releasing the front latch levers and extending the rails.

The extreme performance of Mac Pro requires a tremendously capable thermal system. Three axial fans quietly push air across the CPU and the GPUs, keeping them cool under even the most intensive workloads. On the opposite side, a blower pulls the air across the memory and storage and through the power supply, exhausting it out the back of the machine.

Mac Pro is also available in a rack mount—with all the same performance, features, and configuration options as the tower—for deployments better suited to a rack design. The rack mount features the airflow-maximizing 3D lattice and stainless steel handles on the front, and tool-less stainless steel slide rails in place of feet or optional wheels. A top cover and a bottom access panel provide access to the internals of the system. Included rack rails support both industry-standard square-hole and threaded-hole racks, from 24 to 42 inches deep.

The end result is a system designed for our pro customers. Robust equipment that delivers the performance, modularity, accessibility, and upgradability pro customers require. A system that is as comfortable under a desk in an architect's office as it is on set in a DIT cart at a video shoot, or in a machine room rendering visual effects.

# Afterburner



## ProRes and ProRes RAW

Apple ProRes is one of the most popular codecs in professional post-production, providing an unparalleled combination of multistream, real-time editing performance, impressive image quality, and reduced storage rates. All ProRes codecs support any frame size (including HD, 2K, 4K, 8K, and larger) at full resolution. The data rates vary based on codec type, image content, frame size, and frame rate.

Apple ProRes RAW is based on the same principles and underlying technology as existing ProRes codecs, but is applied to a camera sensor's pristine raw image data rather than conventional image pixels, ideal for High Dynamic Range (HDR) content creation.

For more information about ProRes and ProRes RAW, see the [Apple ProRes White Paper](#) and the [Apple ProRes RAW White Paper](#).

Afterburner is a PCI Express hardware accelerator expansion card designed for Mac Pro that turbocharges post-production video workflows by offloading ProRes and ProRes RAW video decoding.

Many film and video workflows rely on proxy workflows, where original camera native files are transcoded into lower-resolution proxy files, taking time, compute resources, and additional storage space. Proxy files are then used for editing, and then late in the workflow the files are matched back to the original high-quality camera formats for color grading and finishing.

Afterburner was designed to enable camera native files to be used throughout the workflow without the need for proxies. It does this by offloading the decoding of all flavors of the ProRes video codec, including ProRes 422HQ, ProRes 4444, ProRes XQ, and ProRes RAW, with the exception of interleaved formats that are currently decoded strictly in software, and the final debayer of ProRes RAW images that are done on the GPU. Since the ProRes codec is normally decoded on the CPU, Afterburner frees up CPU resources—allowing more CPU headroom for other video processing or compute demands, or enabling a lower core count Mac Pro to work with demanding high stream count projects.

Architecturally, the Afterburner card is built around an FPGA (field programmable gate array)—a programmable logic chip. The FPGA has over a million system logic cells and can process up to 6.3 billion pixels per second. It uses a secure firmware loading process that ensures it can only run Apple authorized code and can be reprogrammed on the order of 50 milliseconds. The driver that manages the Afterburner card will load-balance ProRes decode tasks across multiple Afterburner cards if installed. With application support, Afterburner and CPU can be utilized together, enabling even higher stream counts and more demanding video projects on Mac Pro.

## Afterburner Performance in Final Cut Pro<sup>1</sup>

Codec	Stream type	28-core Xeon CPU only	CPU plus Afterburner
ProRes 422	4K 30fps	15 streams	16 streams
ProRes RAW	4K 30fps	7 streams	23 streams
	8K 30fps	2 streams	6 streams



**Support for Final Cut, DaVinci Resolve, Premiere Pro, and more**

Afterburner is supported by Final Cut Pro, Blackmagic DaVinci Resolve, Adobe Premiere Pro, and other popular video applications.

Afterburner can be installed in any full-length PCI Express slot in Mac Pro; however, it requires a PCI Express x16 slot to deliver the highest stream counts due to the bandwidth required for decoded video frames. When ordered from Apple with a Mac Pro, it will be preinstalled in the factory in slot 5, a full-length x16 slot. Afterburner is not supported in a Thunderbolt PCI Express expansion chassis and is not supported in Boot Camp under Windows.

Afterburner accelerates ProRes and ProRes RAW playback in applications that use Apple's VideoToolbox APIs, including the latest versions of Final Cut Pro, Blackmagic DaVinci Resolve, Adobe Premiere Pro, QuickTime Player, and other media applications. Final Cut Pro has support for load-balancing ProRes decode, allowing it to take advantage of both Afterburner and CPU cores for enhanced decode performance.



# Pro Display XDR



## Pro Display XDR

For detailed information, review the [Pro Display XDR Technology Overview](#).

Displays are incredibly important to many professionals: video editors, photographers, colorists, 3D animators, and more rely on display front-of-screen quality to see the color, contrast, and detail in their content.

Apple Pro Display XDR, the ultimate display for Mac Pro, introduces innovative display technologies that set a new industry standard for incredible reference-quality imaging—1000 nits sustained full-screen brightness, 1600 nits peak, and a 1,000,000:1 contrast ratio—at a fraction of the size, weight, and price of traditional reference monitors. Now all professionals throughout the workflow will be able to view, create, edit, color, animate, and more with the true-to-life image quality they desire.

## Key Features

**32-inch LCD.** Pro Display XDR boasts a massive 32-inch LCD display with edge-to-edge glass and only 9 mm borders.

**Retina 6K resolution.** With 6016-by-3384 resolution and 218 pixels per inch, Pro Display XDR is the largest Retina display Apple has ever made. Its 20.4 million pixels make it almost 40 percent larger than iMac with 5K Retina display, giving pros even more room for tools and content.

**P3 wide color gamut, 10-bit color depth.** P3 wide color gamut and true 10-bit color depth provide over a billion colors and incredibly smooth gradients.

**Extreme Dynamic Range (XDR).** Extreme Dynamic Range takes brightness and contrast to a level never seen before, for images that are truer to life than ever. Pro Display XDR sustains a production-ready 1000 nits of full-screen brightness and up to 1600 nits peak, enabled by the light efficiency algorithm in the timing controller (TCON) and the innovative cooling system. An astonishing contrast ratio of 1,000,000:1 provides front-of-screen quality previously reserved for reference displays.

**Superwide viewing angle.** An Apple-designed, industry-leading polarizer technology provides 25x better off-axis contrast than a typical LCD display.

**Reference modes.** Industry-standard reference modes for HDR, HDTV, NTSC video, digital cinema, and more are available as presets on Pro Display XDR.

**Thunderbolt 3 connectivity.** Pro Display XDR connects seamlessly to Mac with one Thunderbolt 3 cable. Connect up to six with certain configurations of Mac Pro.

**Nano-texture glass option.** Standard glass with antireflective coating provides extremely low reflectivity. For less controlled lighting conditions, an incredibly innovative nano-texture glass option scatters light while maintaining contrast.

**Stunning, professional design.** Pro Display XDR has a stunning design, with every element built for pros and featuring the same gorgeous and functional lattice pattern as Mac Pro.

# macOS Big Sur



Powerful computers inspire us to produce our best work. macOS Big Sur brings you incredible technologies designed to take full advantage of hardware capabilities in Mac Pro. You'll get unprecedented up to 28-core processing power, support for large amounts of physical memory, accelerated graphics through Metal, extremely fast ProRes and ProRes RAW playback with Afterburner, QuickTime enhancements for pro users, and support for the display capabilities of Pro Display XDR. macOS Big Sur also introduces three dedicated media apps for Music, TV, and Podcasts, innovative features like Sidecar, and more for everyone.

## Kernel Optimizations

Mac Pro delivers capabilities beyond any previous Mac hardware: up to 28-core processing, up to 1.5TB of physical memory, and eight PCI Express expansion slots. To enable these capabilities and maximize performance, several kernel-level enhancements were implemented. Scheduler optimizations were made for high core count CPUs. Memory management and allocation optimization were made to support large physical memory.

## Metal

Metal is the modern foundation for accelerated graphics and compute on Apple platforms and provides the essential API for app developers to tap into the incredible power of Mac Pro graphics. Metal provides near-direct access to the GPU, and its efficient low-overhead architecture offers an array of capabilities such as multithreading, fine-grain resource control, and GPU-driven rendering pipelines, which enable pro apps to more fully access the amazing potential of Mac Pro.

**Metal-enabled graphics pipeline.** Key parts of the macOS graphics pipeline, including the Window Server, have been optimized to use Metal. Graphics pipelines in frameworks such as Core Image, RAW image processing, and ProRes RAW debayering utilize Metal for GPU processing performance.

**Metal Performance Shaders.** The Metal Performance Shaders (MPS) framework contains a collection of highly optimized compute and graphics shaders that are designed to integrate easily and efficiently into your Metal app. These data-parallel primitives are tuned to take advantage of the hardware characteristics of each GPU family to ensure optimal performance.

In macOS Big Sur, the MPS ray tracing operations have been enhanced for performance by moving the bounded volume hierarchy construction to the GPU. MPS also provides optimized de-noising filters in an essential collection of highly optimized compute and graphics shaders.

**Metal for pro apps.** Metal gives app developers explicit control over GPU workloads in Mac Pro, allowing applications to better harness CPU and GPU parallelism for dramatically increased pro app performance. Metal peer groups make it easy to rapidly share data between multiple GPUs in Mac Pro without transferring through main memory, using Infinity Fabric Link in the AMD Radeon Pro Vega II and W6000-Series GPUs. Further, CAMetalLayer gives you access to the High Dynamic Range capabilities of Pro Display XDR.

**Metal-enabled iOS simulator.** The simulator uses Metal to speed up the development of iOS apps that either use Metal directly or rely on Metal-based system frameworks. Now you can simulate graphics-intensive iOS applications like games in high performance using Metal and the powerful GPUs in Mac Pro.

**Create ML.** Developers can use Create ML, part of the Xcode developer toolset, to build, train, and deploy machine learning models with no machine learning expertise required. Create ML lets you view model creation workflows in real time, creating models with your custom data without needing a dedicated server. Create ML is accelerated by GPU processing using Metal.

Find out more about [Core ML](#) and [Create ML](#).

## QuickTime Player

QuickTime Player has been enhanced with features requested by pros to aid in content creation and review workflows. QuickTime Player can create video content from a still image sequence, allowing you to choose the desired resolution, frame rate, and encoding quality. Transparency is preserved when exporting ProRes 4444 content to HEVC. When embedded in a media file, timecode is presented in the onscreen navigation controller. And an enhanced movie inspector shows even more in-depth technical information about a file, including the video color space, HDR format, bit depth, scale, and aspect ratio.

## Sidecar

Sidecar lets you extend your macOS workspace across your iPad display and sketch in apps with Apple Pencil.<sup>6</sup> Just like a secondary monitor, you can work in one app while you reference another, or view artwork on your Mac while you use tools and palettes on your iPad display. You can also use Apple Pencil on your iPad display to sketch, draw, edit, or annotate in your favorite Mac apps. It's also possible to mirror the screens so they both display the same content, making it perfect for sharing exactly what you see with others.

## Refinements

macOS Big Sur elevates the most advanced desktop operating system in the world to a new level of power and beauty. Experience Mac to the fullest with a refined design. Dark Mode highlights pro content while controls recede into the background on the stunning Retina display. Safari is packed with features, including quick and easy translation, a privacy report, and an elegantly designed and customizable start page. With an updated Messages app, you can send and receive more personal and expressive messages. Files on macOS can be quickly browsed, and get easy access to metadata with Gallery View in Finder. Everything comes together beautifully in a fantastic experience that feels focused, fresh, and instantly familiar.



### Boot Camp

Mac Pro can boot Windows 10 natively through Boot Camp. With the exception of Afterburner, all Mac Pro configurations are supported in Windows. For further information, visit the [Boot Camp Support](#) page.

# Performance

The most powerful Mac that Apple has ever built, Mac Pro packs the latest workstation-class processor, memory, graphics, and I/O technologies in a modular, configurable, upgradable enclosure. It delivers phenomenal performance across a range of professional applications.

## Processor Performance

**Logic Pro.<sup>2</sup>** Logic Pro X gives you all the tools you need to create, edit, and deliver your best music. The latest release of Logic Pro is optimized for Mac Pro.



**Logic Pro – more Amp Designer plug-ins**

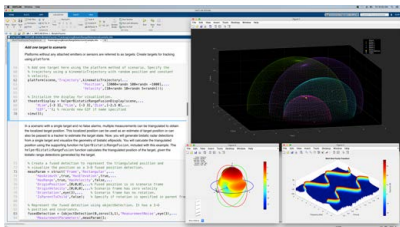
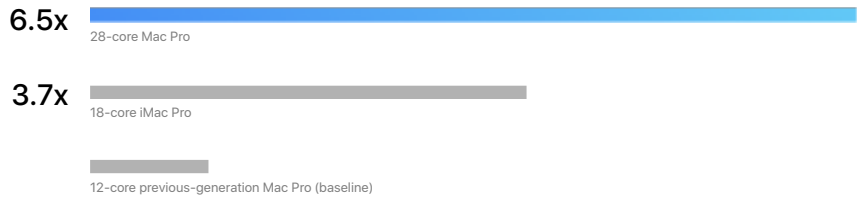

**MATLAB.<sup>3</sup>** is a programming platform designed specifically for engineers and scientists, enabling data analysis, algorithmic development, simulation of models, and creation of custom applications.

**MATLAB – faster simulation of dynamical systems**

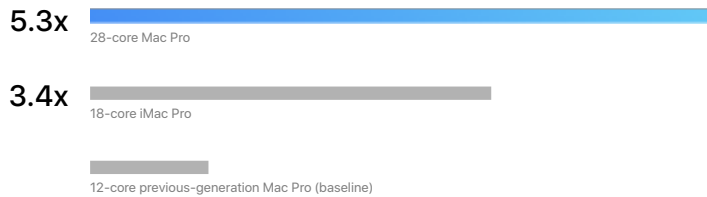



**Adobe Photoshop 2020.**<sup>7</sup> Adobe Photoshop is at the core of just about every creative project, from photo editing and compositing to digital painting, animation, and graphic design.

**Adobe Photoshop CC – faster processing of well-threaded filters**

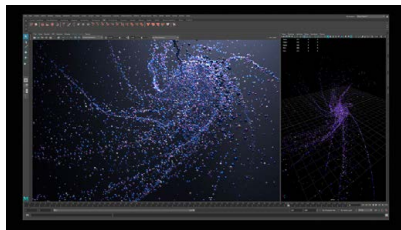
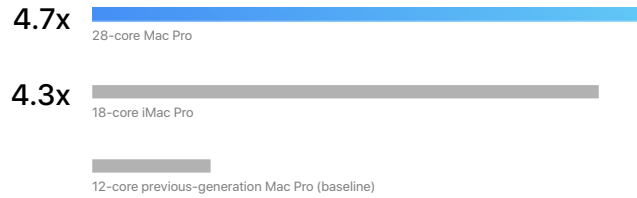

**Autodesk Maya.**<sup>8</sup> Maya is integrated with Arnold renderer, which helps solve complex rendering problems and makes it simple to render high-quality images quickly and efficiently.

**Autodesk Maya – faster Arnold render**

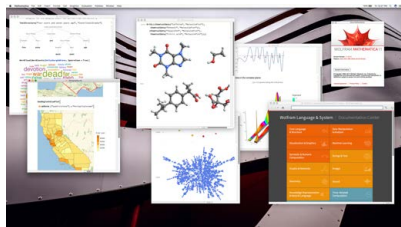
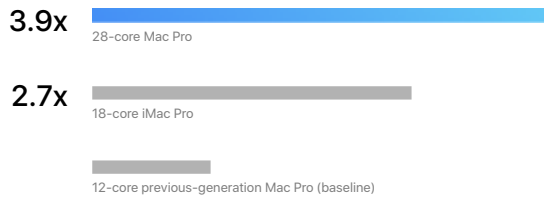

**Wolfram Mathematica.**<sup>9</sup> Mathematica provides a single integrated, continually expanding system that covers the breadth and depth of technical computing.

**Wolfram Mathematica – faster CPU benchmark performance**

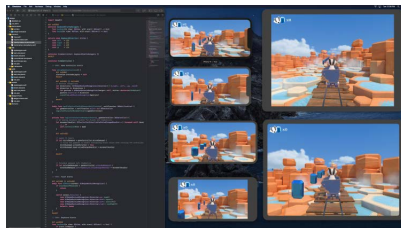
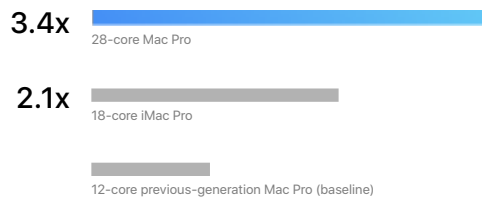

**Build Time.**<sup>10</sup> Edit, Compile, Test, Repeat. Faster than ever before.

**Faster build time – Clang, LLVM, and compiler-rt using Ninja**

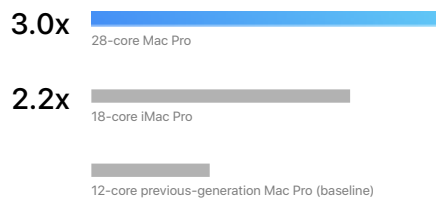

# Graphics Performance

**OTOY Octane X.**<sup>11</sup> Fast and powerful, Octane X is an industry-leading unbiased spectral GPU render engine. Fully optimized for Metal, it delivers incredible realism, quality, and speed.

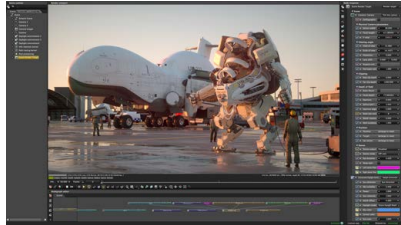

## OTOY Octane X – faster render

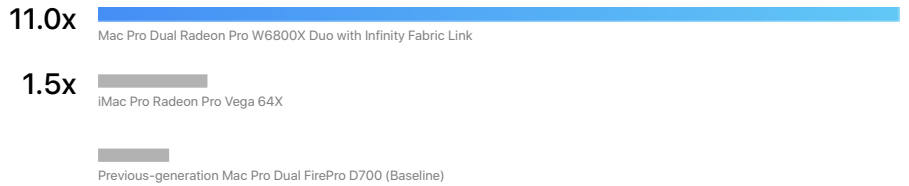

**Maxon Cinema 4D.**<sup>12</sup> A professional 3D modeling, animation, simulator, and rendering package, Cinema 4D is a fast, flexible, and powerful toolset to make 3D workflows more accessible.

## Maxon Cinema 4D – faster real-time 3D performance

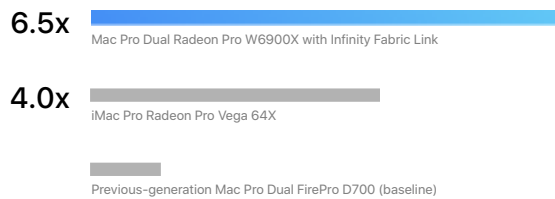

**Blackmagic DaVinci Resolve Studio.**<sup>13</sup> Grade, finish, and deliver your project, in HD, 4K, or even 8K. Extensive CPU, GPU, Metal, and Afterburner optimizations make DaVinci Resolve faster and more responsive than ever.

## Blackmagic DaVinci Resolve Studio – faster effects render

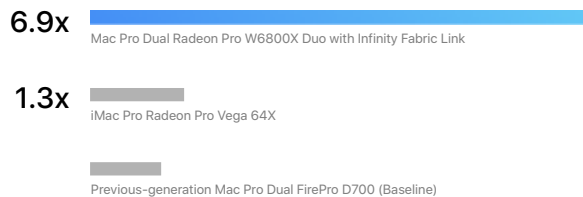

**Final Cut Pro.**<sup>14</sup> Final Cut Pro is built on a modern 64-bit architecture that is optimized for the high-performance CPU, graphics, and Afterburner in Mac Pro, allowing editors to work with full-resolution 8K ProRes in real time.

## Final Cut Pro – faster render speed

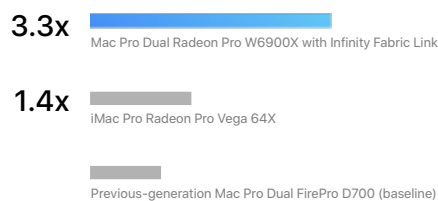

# Configuring Mac Pro

Mac Pro is designed to be custom configured to your specific workflow requirements. With up to 28-core processing, 1.5TB of RAM, eight expansion slots, up to four GPUs, and up to 12 Thunderbolt 3 ports, Mac Pro has unprecedented configuration capabilities. Below are some considerations for configuring and optimizing Mac Pro for your needs.

## Enclosure Considerations

Mac Pro is offered in both tower and rack configurations. While the main logic board and internal modules are shared, each configuration utilizes a unique enclosure, and therefore the form factor must be decided at time of order—the tower is not reconfigurable into a rack system.

The tower enclosure comes standard with feet; wheels are a configurable option. Both feet and wheels are available as a customer-installable kit and therefore can be converted from feet to wheels or vice versa.

The Mac Pro tower enclosure can be physically secured using the Belkin Lock Adapter for Mac Pro and an appropriate lock or cable lock system.

The rack enclosure is a 5U system and includes stainless steel tool-less rack rails that support both square-hole and threaded racks. Rack rails are included with the rack enclosure but ship in a separate box from Mac Pro.

## Processor Considerations

Mac Pro features Intel Xeon W processors from 8 to 28 cores. The base 8-core processor delivers outstanding performance with a 3.5GHz clock speed, Turbo Boost performance up to 4.0GHz, and support for up to 768GB of DDR4 ECC memory at 2666MHz. The 8-core Mac Pro provides an alternative to the 8-core iMac or iMac Pro, with a modular, upgradable enclosure that provides increased graphics and display configurability and increased connectivity.

Higher core count Xeon processors deliver increased multithreaded performance. While they have a decreased base clock (from 3.3GHz for the 12-core to 2.5GHz for the 28-core), the higher core count delivers greater performance for applications that scale with cores. All Xeon W processors above 8-core have a maximum Turbo Boost speed of 4.4GHz, reducing the performance impact when running lightly threaded applications. It is important to know if your primary applications can scale to higher core counts to get maximum

### **Belkin Lock Adapter**

The [Belkin Lock Adapter for Mac Pro](#) mounts to the tower enclosure to provide physical security to Mac Pro.



performance from top-end Xeon processors. Higher core count systems will deliver greater performance when running multiple demanding applications simultaneously, such as background CPU-based rendering while running foreground applications, running multiple iOS simulators in an Xcode developer workflow, or running multiple virtual machines.

Processors above 8-core provide 2933MHz DDR4 ECC memory up to 768GB; 24-core and 28-core processors support up to 1.5TB of physical memory.

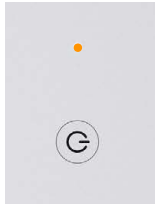

#### **Status Indicator Light**

The status indicator light (SIL) on the top of the tower enclosure, front of the rack enclosure, or back of both will blink amber if the system encounters a memory error on boot. One possible reason is mixing R-DIMMs and LR-DIMMs in the same system.

## **Memory Considerations**

All Mac Pro configurations feature 12 DIMM slots supporting 2933MHz DDR4 ECC memory, although the 8-core Xeon operates at 2666MHz. Mac Pro starts at 32GB of memory using four 8GB DIMMs. For maximum performance, populate all six channels of memory in the system.

Memory in Mac Pro is user configurable using industry-standard 2933MHz DDR4 ECC memory.

Mac Pro supports both R-DIMMs (registered DIMMs) and LR-DIMMs (load-reduced DIMMs); however, all DIMMs in the system must be of the same type. If you plan on adding memory to Mac Pro after initial purchase, be sure to match the type of memory, or plan on replacing all DIMMs in the system. Information about the number of modules and type and speed of memory installed in your Mac Pro can be found in “About this Mac” in the Memory tab or in the System Information utility.

For more information on installing memory in Mac Pro, visit the [Mac Pro Support](#) page.

## Graphics Considerations

Mac Pro offers several MPX-based graphics configurations with single, dual, and quad GPU configurations. Further, most Mac Pro MPX graphics modules are sold separately to enable post-purchase upgrading. Mac Pro also supports a number of AMD off-the-shelf graphics cards.

MPX graphics modules provide the seamless integration and, with most modules, enhanced Thunderbolt connectivity. Radeon Pro W6000-Series MPX Modules support Infinity Fabric Link across two identical modules and Radeon Pro W6800X Duo MPX Modules support Infinity Fabric Link onboard across the two W6800X GPUs on the module and across two W6800X Duo modules when installed.

Video applications that take advantage of Infinity Fabric Link—such as Final Cut Pro and Blackmagic DaVinci Resolve—will benefit from the PCIe bandwidth of the single W6800X or W6900X card for moving video data to and from the system over PCIe and between the GPUs using Infinity Fabric Link. The W6800X Duo module provides maximum GPU compute in Mac Pro, providing up to four W6800X GPUs across two W6800X Duo modules, 60.4 teraflops of compute, and 128GB of GDDR6 memory across the four GPUs. Applications optimized for multiple GPUs benefit most from this maximum configuration, such as GPU-based rendering engines and machine learning.

The Radeon Pro 580X MPX Module provides strong graphics performance and is a great solution for non-graphics-intensive applications. Like all MPX graphics modules, it provides video support for built-in Thunderbolt 3 ports, enabling Thunderbolt 3 display connectivity to displays like Pro Display XDR or LG UltraFine 5K. This module also enables six PCIe slots for maximum expandability and is needed for applications like Avid Pro Tools when installing six HDX cards.



### Belkin AUX Power Cable Kit

The [Belkin AUX Power Cable Kit for Mac Pro](#) provides the key AUX power cables needed for many third-party PCIe cards and GPUs. Four 8-pin to 8-pin, one 6-pin to 6-pin, or one 8-pin to dual 6-pin cable provide the most common connectivity.

Mac Pro supports many off-the-shelf AMD graphics cards. For a list of currently supported GPUs, visit the [Mac Pro Support page](#). Third-party GPUs typically require AUX power. Mac Pro provides four 8-pin (150W each) AUX power connectors that support the Belkin AUX Power Cable Kit. Note that at least one Apple MPX Module is required to provide video support over Mac Pro Thunderbolt 3 ports; without one, Thunderbolt 3 ports become data only and are unable to light a display. AUX power ports are disabled (as well as not physically accessible) when an MPX Module is installed in the corresponding bay as that power is routed to the MPX connector.



### **Teradici CAS for macOS**

With [Teradici CAS](#), Mac users can access their high-performance workflows—including VFX, animation, structural design, video editing, and other high-performance creator and design workflows—from anywhere. Using the Teradici PCoIP remote display protocol to transfer only pixels, corporate assets remain securely located in industry-compliant, onsite content networks.

## **Display Considerations**

With up to 12 Thunderbolt 3 ports across four GPUs, Mac Pro can support up to twelve 4K displays, six 5K displays, or six Pro Display XDR displays. Thunderbolt 3 can also support DisplayPort displays with the appropriate cable or adapter; or be adapted to DVI, HDMI, and even VGA displays.

Thunderbolt 3 optical cables enable distances up to 50M.

## **Expansion Considerations**

With eight PCI Expansion slots, Mac Pro provides high-bandwidth internal expansion for demanding I/O solutions such as Fibre Channel, SAS, RAID engines, 40/50/100Gb Ethernet, NVMe SSD, SDI input and output, and audio DSP processing cards.

In a video editing configuration with two MPX graphics modules and the Apple I/O card, three full-length PCIe card slots and 12 Thunderbolt 3 ports are available for expansion—room to support storage solutions like Fibre Channel, Afterburner, and SDI I/O cards if needed.

Afterburner is a must-have option for any video editor working in a ProRes workflow. When configured with Mac Pro, Afterburner comes preinstalled in slot 5 to deliver maximum performance in that PCIe x16 slot. Also sold separately as a kit, Afterburner can be installed in any available full-length PCIe slot, but should be installed in the x16 slot for maximum performance (highest stream count), especially when working in multistream 4K or 8K workflows.

## Example Configurations

Below are example Mac Pro configurations for several typical use cases. Not meant to be prescriptive, these configurations provide a starting point for configuration for various workflows that you can use to configure further based on your own unique configuration needs.

Nonlinear Video Editing Workstation		
<b>Processor</b>	16-core Intel Xeon	Strong multicore performance for system performance; consider increased core count when working with codecs like RED R3D
<b>Memory</b>	48GB (6x8GB)	Full memory performance and enough for most NLEs; consider increasing to 96GB or more memory if running multiple large applications simultaneously
<b>Graphics</b>	Two W6800X GPUs with Infinity Fabric Link	Enhanced real-time effects performance; increased ProRes RAW performance (GPU debayering); maximum PCIe bandwidth to each GPU for video
<b>Storage</b>	1TB SSD	Good system boot, user home directory, and application performance; assuming external storage (SAN, DAS, or NAS) for primary media storage
<b>Expansion</b>	Afterburner	Must-have for any ProRes workflow—will greatly accelerate system performance by offloading ProRes decode and freeing CPU for other work; Final Cut Pro, Adobe Premiere Pro, and DaVinci Resolve support
<b>Other</b>	Pro Display XDR	Outstanding front-of-screen quality for critical viewing; full-screen video output support in major NLEs; 10-bit color and HDR support
	Fibre Channel PCIe card or Thunderbolt 3 storage	Primary media storage; multidrive capacity and performance

Digital Audio Workstation		
<b>Processor</b>	28-core Intel Xeon	Outstanding CPU performance for high track count projects and real-time effects and instrument processing
<b>Memory</b>	96GB (6x16GB)	Full memory performance; robust capacity for virtual instruments and plug-ins; consider increased memory based on specific plug-in and instrument requirements
<b>Graphics</b>	Radeon Pro 580X	Strong video performance for display needs; supports up to 2x 5K or 2x Pro Display XDR displays; enables 6 PCIe slots for audio DSP cards
<b>Storage</b>	4TB SSD	Capacity for system, projects, and large virtual instruments; consider 1TB or 2TB if only needed for boot and system needs and using external storage for primary project storage
<b>Expansion</b>	–	No additional Apple expansion options suggested; 6 available PCIe slots available for audio DSP or internal storage options
<b>Other</b>	Promise Pegasus R4i	Internal RAID storage option with 32TB of raw capacity and RAID 5 support

3D/VFX Workstation with GPU Rendering		
<b>Processor</b>	16-core Intel Xeon	Strong multicore performance for system performance
<b>Memory</b>	192GB (6x32GB)	Large memory capacity provides room for many demanding applications simultaneously
<b>Graphics</b>	Two W6800X Duo GPUs	Four W6800X GPUs with up to 60.4 teraflops compute performance and 128GB GDDR6 memory for multi-GPU based rendering engines
<b>Storage</b>	2TB SSD	Good system boot, user home directory, and application performance; assuming external storage (SAN, DAS, or NAS) for primary media storage
<b>Expansion</b>	–	No additional Apple expansion options suggested; 3 available PCIe slots for options like internal NVMe storage, SDI output, or 40Gb Ethernet connectivity
<b>Other</b>	Pro Display XDR	Outstanding front-of-screen quality for critical viewing; 10-bit color and HDR support

Developer Workstation		
<b>Processor</b>	16-core Intel Xeon	Strong multicore performance for system performance, large project compilation, multiple VMs or iOS simulators, automated testing and continuous integration
<b>Memory</b>	192GB (6x32GB)	Large memory capacity provides room for many tasks running simultaneously
<b>Graphics</b>	Radeon Pro W5700X	Outstanding graphics performance for Metal-accelerated iOS simulator; ability to drive multiple displays including up to 3 Pro Display XDR displays
<b>Storage</b>	2TB SSD	Good system boot, user home directory, project and application performance
<b>Expansion</b>	–	No additional Apple expansion options suggested

SciTech/Research Workstation		
<b>Processor</b>	28-core Intel Xeon	Maximum multicore performance for system performance; supports maximum memory capacity
<b>Memory</b>	192GB (6x32GB)	Large memory capacity provides room for large data sets and many tasks running simultaneously
<b>Graphics</b>	Radeon Pro W5700X	Outstanding graphics performance for general-purpose usage; ability to drive multiple displays including up to 3 Pro Display XDR displays; consider upgrading to single or multiple Radeon Pro W6800 or W6800 Duo graphics for GPU compute or machine learning applications
<b>Storage</b>	2TB SSD	Good system boot, user home directory, project and application performance
<b>Expansion</b>	–	No additional Apple expansion options suggested
<b>Other</b>	Promise Pegasus R4i	Internal RAID storage option with 32TB of raw capacity and RAID 5 support for local data storage

# Product Details

## Configuration Options

---

<b>Processor</b>	3.5GHz 8-core Intel Xeon with Turbo Boost up to 4.0GHz 3.3GHz 12-core Intel Xeon with Turbo Boost up to 4.4GHz 3.2GHz 16-core Intel Xeon with Turbo Boost up to 4.4GHz 2.7GHz 24-core Intel Xeon with Turbo Boost up to 4.4GHz 2.5GHz 28-core Intel Xeon with Turbo Boost up to 4.4GHz	
<b>Memory</b>	32GB (4x8GB) 48GB (6x8GB) 96GB (6x16GB) 192GB (6x32GB)	384GB (6x64GB) 768GB (6x128GB) 1.5TB (12x128GB) <sup>4</sup>
<b>Graphics</b>	AMD Radeon Pro 580X with 8GB GDDR5 memory AMD Radeon Pro W5500X with 8GB GDDR6 memory AMD Radeon Pro W5700X with 16GB GDDR6 memory Two AMD Radeon Pro W5700X, each with 16GB GDDR6 memory AMD Radeon Pro W6800X with 32GB GDDR6 memory Two AMD Radeon Pro W6800X, each with 32GB GDDR6 memory AMD Radeon Pro W6900X with 32GB GDDR6 memory Two AMD Radeon Pro W6900X, each with 32GB GDDR6 memory AMD Radeon Pro W6800X Duo with 2x 32GB GDDR6 memory Two AMD Radeon Pro W6800X Duo, each with 2x 32GB GDDR6 memory	
<b>Storage</b>	256GB SSD 1TB SSD 2TB SSD	4TB SSD 8TB SSD
<b>Expansion</b>	Afterburner card	
<b>Keyboard</b>	Magic Keyboard with Numeric Keypad	
<b>Input</b>	Magic Mouse 2 Magic Trackpad 2 Magic Mouse 2 + Magic Trackpad 2	
<b>Enclosure</b>	Tower enclosure with feet Tower enclosure with wheels Rack enclosure with rack mounting kit	

---

## Related Apple Products

<b>Display</b>	Apple Pro Display XDR Apple Pro Display Stand Apple Pro Display VESA Adapter
<b>Memory</b>	Apple 16GB (2x8GB) DDR4 ECC R-DIMM Memory kit Apple 32GB (2x16GB) DDR4 ECC R-DIMM Memory kit Apple 64GB (2x32GB) DDR4 ECC R-DIMM Memory kit Apple 128GB (2x64GB) DDR4 ECC LR-DIMM Memory kit Apple 256GB (2x128GB) DDR4 ECC LR-DIMM Memory kit
<b>MPX Modules</b>	Radeon Pro 580X with 8GB GDDR5 memory MPX Module kit Radeon Pro W5500X with 8GB GDDR6 memory MPX Module kit Radeon Pro W5700X with 16GB GDDR6 memory MPX Module kit Radeon Pro W6800X with 32GB GDDR6 memory MPX Module kit Radeon Pro W6900X with 32GB GDDR6 memory MPX Module kit Radeon Pro W6800X Duo with 2x 32GB GDDR6 memory MPX Module kit
<b>Storage</b>	1TB SSD kit                      4TB SSD kit 2TB SSD kit                      8TB SSD kit
<b>Expansion</b>	Afterburner card kit
<b>Enclosure</b>	Foot kit for tower enclosure Wheel kit for tower enclosure

## Related Third-Party Products

<b>Storage</b>	Promise Pegasus J2i with 8TB SATA drive Promise Pegasus R4i with 32TB (4x8TB) drives MPX Module
<b>Enclosure</b>	Belkin Lock Adapter for Mac Pro Belkin AUX Power Cable Kit for Mac Pro



## AppleCare+ for Mac Pro

AppleCare+ for Mac Pro provides three years of global repair coverage, both parts and labor, and it includes up to two incidents of accidental damage. In addition to bringing in your device for service, you can also schedule an onsite service appointment in many countries where Apple certified technicians will come to your location.<sup>15</sup>

Plus you'll get priority access to Apple experts by chat or phone for questions on a wide range of topics, including using macOS, iCloud, Photos, Apple-branded pro apps, such as Final Cut Pro, Logic Pro, and more.

For more information, visit [apple.com/support/products/mac](https://apple.com/support/products/mac).



## AppleCare for Enterprise

Tailored to meet the needs of your organization, AppleCare for Enterprise provides IT departments and end users with around-the-clock telephone assistance from Apple's award-winning customer support group and offers flexible service options, ranging from priority onsite repair or replacement to onsite managed service inventory. AppleCare for Enterprise is available for businesses with multiple locations in countries around the world.

If you experience a hardware or a software configuration issue, you'll get direct, one-stop access to Apple's dedicated Enterprise Technical Support team who will help diagnose the issue and work to get you up and running quickly.

AppleCare for Enterprise provides consultative telephone and email support for Apple hardware, current versions of iOS, iPadOS, macOS, Apple-based solutions and applications, and complex deployment and integration scenarios including MDM and Active Directory.

To minimize downtime, AppleCare for Enterprise even provides the option for quick and easy swapping of devices you keep on hand so you won't have to wait for a repair technician.

Enterprise solutions require expert service and support to match. AppleCare for Enterprise provides the customized service and support you need to keep your workforce productive in the office and on the road.

For more information, visit [apple.com/support/professional/enterprise/](https://apple.com/support/professional/enterprise/).



# Technical Specifications

## Hardware

### Processor

- 3.5GHz 8-core Intel Xeon W (Turbo Boost up to 4.0GHz)
- Configurable to 12-core, 16-core, 24-core, or 28-core Intel Xeon processor
- All Xeon W processors support Turbo Boost and Hyper-Threading

Processor	Base Frequency	Max Turbo Boost Frequency	Cache	Memory Support
8-Core (W-3223)	3.5GHz	4.0GHz	24.5MB	Supports up to 768GB at 2666MHz
12-Core (W-3235)	3.3GHz	4.4GHz	31.25MB	Supports up to 768GB at 2933MHz
16-Core (W-3245)	3.2GHz	4.4GHz	38MB	Supports up to 768GB at 2933MHz
24-Core (W-3265M)	2.7GHz	4.4GHz	57MB	Supports up to 1.5TB at 2933MHz
28-Core (W-3275M)	2.5GHz	4.4GHz	66.5MB	Supports up to 1.5TB at 2933MHz

### Memory

- 32GB (4x8GB) memory
- 2933MHz DDR4 ECC memory (8-core CPU operates at 2666MHz; all other processors run at 2933MHz)
- Up to 1.5TB of memory (24- and 28-core processors; 8-, 12-, and 16-core configurable to 768GB)

## Graphics and Video Support

- Radeon Pro 580X graphics processor with 8GB GDDR5 memory
- Configurable to single or dual Radeon Pro W6900X graphics processor with 32GB GDDR6 memory or Radeon Pro W6800X Duo graphics processor with 64GB GDDR6

Graphics Processor	Compute Units	Memory	Teraflops (FP32/FP16)	Video Support
Radeon Pro 580X	36	8GB GDDR5	5.6	Two HDMI 2 ports; four DisplayPort connections to internal Thunderbolt 3 ports
Radeon Pro W5500X	24	8GB GDDR6	5.6 / 11.2	Two HDMI 2 ports; two DisplayPort connections to internal Thunderbolt 3 ports
Radeon Pro W5700X	40	16GB GDDR6	9.4 / 18.9	Four Thunderbolt 3 ports plus one HDMI 2 port; two DisplayPort connections to internal Thunderbolt 3 ports
Radeon Pro W6800X	60	32GB GDDR6	16.0 / 32.0	Four Thunderbolt 3 ports plus one HDMI 2 port; two DisplayPort connections to internal Thunderbolt 3 ports
Radeon Pro W6900X	80	32GB GDDR6	22.2 / 44.4	Four Thunderbolt 3 ports plus one HDMI 2 port; two DisplayPort connections to internal Thunderbolt 3 ports
Radeon Pro W6800X Duo	2x60	2x32GB GDDR6	2x16.0 / 2x32.0	Four Thunderbolt 3 ports plus one HDMI 2 port; four DisplayPort connections to internal Thunderbolt 3 ports

## Storage

- 256GB SSD secured by Apple T2 Security Chip
- Configurable to 1TB, 2TB, 4TB, or 8TB SSD

## Expansion Slots

- Supports two MPX Modules
  - Each provides x16 gen 3 bandwidth for graphics, x8 gen 3 for Thunderbolt, DisplayPort video routing, and up to 500W power for an Apple MPX Module
  - Alternatively, each MPX bay can support a full-length, double-wide x16 gen 3 slot and a second full-length, double-wide x8 gen 3 slot (MPX bay 1) or x16 gen 3 (MPX bay 2) with up to 300W AUX power via two 8-pin connectors
- Supports three full-length PCI Express gen 3 slots
  - One x16, two x8 slots
- Supports one half-length, x4 gen 3 slot populated with Apple I/O card

## Connections

- Four Thunderbolt 3 ports (two on top, two on back)
- Two USB 3 ports
- Dual 10Gb Ethernet (Nbase-T, supports 1Gb / 2.5Gb / 5Gb / 10Gb) using RJ-45 connector

## **Audio**

- Built-in speaker
- 3.5 mm headphone jack

## **Input**

- Magic Keyboard with Numeric Keypad
- Magic Mouse 2

## **Wireless**

- 802.11ac Wi-Fi wireless networking, IEEE 802.11a/b/g/n compatible
- Bluetooth 5.0

## **Size and Weight**

### **Tower**

- Height: 20.8 inches (52.9 cm)
- Height (including wheels): 21.9 inches (55.7 cm)
- Width: 8.58 inches (21.8 cm)
- Depth: 17.7 inches (45.0 cm)
- Weight: 39.7 pounds (18 kg)<sup>16</sup>

### **Rack**

- Height: 8.67 inches (22.02 cm) – 5U
- Width: 18.98 inches (48.2 cm)
- Depth: 19.43 inches (49.35 cm)
- Depth (including handles): 21.24 inches (53.95 cm)
- Weight: 38.8 pounds (17.6 kg)<sup>16</sup>

## **Electrical and Operating Requirements**

- Line voltage: 100–125V AC @ 12A / 220–240V AC @ 6A
- Frequency: 50Hz to 60Hz, single phase
- Maximum continuous power:
  - 1280W at 108–125V or 220–240V
  - 1180W at 100–107V
- Operating temperature: 50° to 95° F (10° to 35° C)
- Storage temperature: –40° to 116° F (–40° to 47° C)
- Relative humidity: 5% to 95% noncondensing
- Operating altitude: tested to 16,400 feet (5000 meters)

# Software

## For More Information

For more information about Mac Pro, Pro Display XDR, macOS Big Sur, and other Apple products, visit [apple.com/mac](https://apple.com/mac).

## macOS Big Sur

macOS is the operating system that powers every Mac. macOS Big Sur brings a refined design, powerful controls, and intuitive customization options to the most advanced desktop operating system in the world.

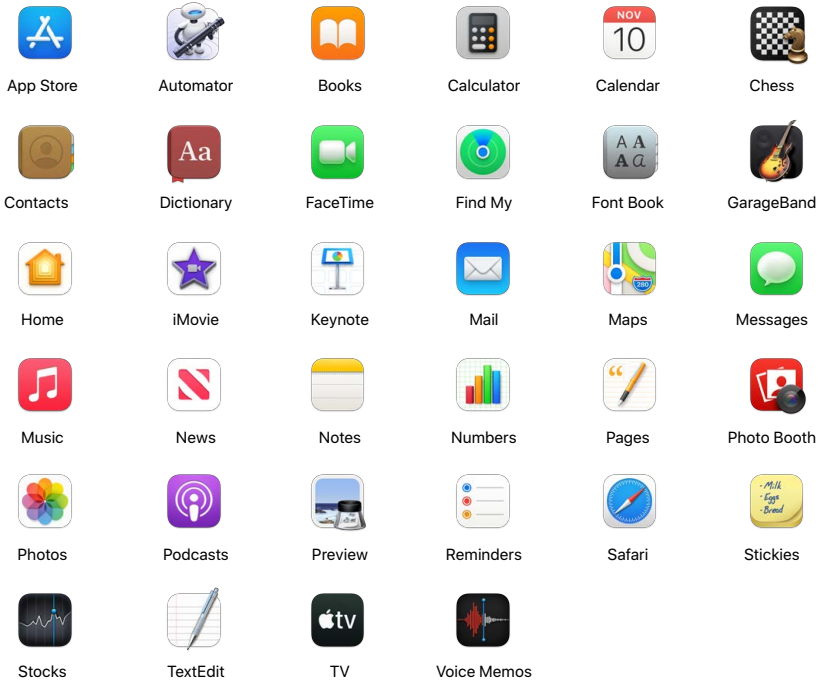

Performance tests are conducted using specific computer systems and reflect the approximate performance of Mac Pro. Information about products not manufactured by Apple, or independent websites not controlled or tested by Apple, is provided without recommendation or endorsement. Apple assumes no responsibility with regard to the selection, performance, or use of third-party websites or products. Apple makes no representations regarding third-party website accuracy or reliability. Risks are inherent in the use of the internet. Contact the vendor for additional information.

1. Testing conducted by Apple in November 2019 using preproduction 2.5GHz 28-core Intel Xeon W-based Mac Pro systems with 384GB of RAM and dual AMD Radeon Pro Vega II graphics with Infinity Fabric Link and 32GB of HBM2 each, configured with and without Afterburner and a 4TB SSD. Mac Pro systems tested with an attached 5K display. Tested with Final Cut Pro 10.4.7 using a 50-second picture-in-picture project with up to 6 streams of Apple ProRes RAW video at 8192x4320 resolution and 29.97 frames per second, a 50-second picture-in-picture project with up to 23 streams of Apple ProRes RAW video at 4096x2160 resolution and 29.97 frames per second, and a 5-minute picture-in-picture project with up to 16 streams of Apple ProRes 422 video at 4096x2160 resolution and 30 frames per second. Performance tests are conducted using specific computer systems and reflect the approximate performance of Mac Pro.
2. Testing conducted by Apple in November 2019 using preproduction 2.5GHz 28-core Intel Xeon W-based Mac Pro systems with 384GB of RAM and dual AMD Radeon Pro Vega II graphics with Infinity Fabric Link and 32GB of HBM2 each; and shipping 2.3GHz 18-core Intel Xeon W-based 27-inch iMac Pro systems with 256GB of RAM and Radeon Pro Vega 64X graphics with 16GB of HBM2, as well as shipping 2.7GHz 12-core Intel Xeon E5-based Mac Pro systems with 64GB of RAM and dual AMD FirePro D700 graphics with 6GB of VRAM each. Mac Pro systems tested with an attached 5K display. Logic Pro X 10.4.7 tested with project consisting of 253 tracks, each with an Amp Designer plug-in instance applied. Individual tracks were enabled during playback until CPU became overloaded. Performance tests are conducted using specific computer systems and reflect the approximate performance of Mac Pro and iMac Pro.
3. Testing conducted by Apple in November 2019 using preproduction 2.5GHz 28-core Intel Xeon W-based Mac Pro systems with 384GB of RAM and dual AMD Radeon Pro Vega II graphics with Infinity Fabric Link and 32GB of HBM2 each; and shipping 2.3GHz 18-core Intel Xeon W-based 27-inch iMac Pro systems with 256GB of RAM and Radeon Pro Vega 64X graphics with 16GB of HBM2, as well as shipping 2.7GHz 12-core Intel Xeon E5-based Mac Pro systems with 64GB of RAM and dual AMD FirePro D700 graphics with 6GB of VRAM each. Mac Pro systems tested with an attached 5K display. Tested with MATLAB and Simulink R2019b Update 1 and Parallel Computing Toolbox using a vehicle dynamics model. Performance tests are conducted using specific computer systems and reflect the approximate performance of Mac Pro and iMac Pro.
4. 1.5TB memory options require 24-core or 28-core processor.
5. Testing conducted by Apple in November 2019 using preproduction 2.5GHz 28-core Intel Xeon W-based Mac Pro systems with 384GB of RAM and a 4TB SSD. Mac Pro systems tested with an attached 5K display. Tested with FIO 3.16, 1024KB request size, 150GB test file and IO depth=8. Performance tests are conducted using specific computer systems and reflect the approximate performance of Mac Pro.
6. Sidecar requires an iPad that supports Apple Pencil.

7. Testing conducted by Apple in November 2019 using preproduction 2.5GHz 28-core Intel Xeon W-based Mac Pro systems with 384GB of RAM and dual AMD Radeon Pro Vega II graphics with Infinity Fabric Link and 32GB of HBM2 each; and shipping 2.3GHz 18-core Intel Xeon W-based 27-inch iMac Pro systems with 256GB of RAM and Radeon Pro Vega 64X graphics with 16GB of HBM2, as well as shipping 2.7GHz 12-core Intel Xeon E5-based Mac Pro systems with 64GB of RAM and dual AMD FirePro D700 graphics with 6GB of VRAM each. Mac Pro systems tested with an attached 5K display. Prerelease Adobe Photoshop 2020 21.0.04 tested using the crystallize, pointillize, radial blur, dust & scratches, and median filters. Performance tests are conducted using specific computer systems and reflect the approximate performance of Mac Pro and iMac Pro.
8. Testing conducted by Apple in November 2019 using preproduction 2.5GHz 28-core Intel Xeon W-based Mac Pro systems with 384GB of RAM and dual AMD Radeon Pro Vega II graphics with Infinity Fabric Link and 32GB of HBM2 each; and shipping 2.3GHz 18-core Intel Xeon W-based 27-inch iMac Pro systems with 256GB of RAM and Radeon Pro Vega 64X graphics with 16GB of HBM2, as well as shipping 2.7GHz 12-core Intel Xeon E5-based Mac Pro systems with 64GB of RAM and dual AMD FirePro D700 graphics with 6GB of VRAM each. Mac Pro systems tested with an attached 5K display. Autodesk Maya 2019.2 tested using a 399.6MB scene. Performance tests are conducted using specific computer systems and reflect the approximate performance of Mac Pro and iMac Pro.
9. Testing conducted by Apple in November 2019 using preproduction 2.5GHz 28-core Intel Xeon W-based Mac Pro systems with 384GB of RAM and dual AMD Radeon Pro Vega II graphics with Infinity Fabric Link and 32GB of HBM2 each; and shipping 2.3GHz 18-core Intel Xeon W-based 27-inch iMac Pro systems with 256GB of RAM and Radeon Pro Vega 64X graphics with 16GB of HBM2, as well as shipping 2.7GHz 12-core Intel Xeon E5-based Mac Pro systems with 64GB of RAM and dual AMD FirePro D700 graphics with 6GB of VRAM each. Mac Pro systems tested with an attached 5K display. Tested using Mathematica v12 with built-in benchmark, WolframMark. Performance tests are conducted using specific computer systems and reflect the approximate performance of Mac Pro and iMac Pro.
10. Testing conducted by Apple in November 2019 using preproduction 2.5GHz 28-core Intel Xeon W-based Mac Pro systems with 384GB of RAM and dual AMD Radeon Pro Vega II graphics with Infinity Fabric Link and 32GB of HBM2 each; and shipping 2.3GHz 18-core Intel Xeon W-based 27-inch iMac Pro systems with 256GB of RAM and Radeon Pro Vega 64X graphics with 16GB of HBM2, as well as shipping 2.7GHz 12-core Intel Xeon E5-based Mac Pro systems with 64GB of RAM and dual AMD FirePro D700 graphics with 6GB of VRAM each. Mac Pro systems tested with an attached 5K display. Build time tested using Xcode 11.1 (11A1027), ninja (v1.7.2 tag), swift (swift-5.0.1-RELEASE tag), swift-clang (swift-5.0.1-RELEASE tag), swift-llvm (swift-5.0.1-RELEASE tag), swift-cmark (swift-5.0.1-RELEASE tag), swift-compiler-rt (swift-5.0.1-RELEASE tag), and CMake 3.9.4. Performance tests are conducted using specific computer systems and reflect the approximate performance of Mac Pro and iMac Pro.
11. Testing conducted by Apple in July 2021 using shipping 2.5GHz 28-core Intel Xeon W-based Mac Pro systems with 384GB of RAM and preproduction dual AMD Radeon Pro W6800X Duo graphics with Infinity Fabric Link and 64GB of GDDR6 each; and production 2.3GHz 18-core Intel Xeon W-based 27-inch iMac Pro systems with 256GB of RAM and Radeon Pro Vega 64X graphics with 16GB of HBM2, as well as production 2.7GHz 12-core Intel Xeon E5-based Mac Pro systems with 64GB of RAM and dual AMD FirePro D700 graphics with 6GB of VRAM each. Mac Pro systems tested with an attached 5K display. OTOY Octane X Version 10.0.3.5 tested using a 1.19GB scene. Performance tests are conducted using specific computer systems and reflect the approximate performance of Mac Pro and iMac Pro.
12. Testing conducted by Apple in July 2021 using shipping 2.5GHz 28-core Intel Xeon W-based Mac Pro systems with 384GB of RAM and preproduction dual AMD Radeon Pro W6900X graphics with Infinity Fabric Link and 32GB of GDDR6 each; and production 2.3GHz 18-core Intel Xeon W-based 27-inch iMac Pro systems with 256GB of RAM and Radeon Pro Vega 64X graphics with 16GB of HBM2, as well as production 2.7GHz 12-core Intel Xeon E5-based Mac Pro systems with 64GB of RAM and dual AMD FirePro D700 graphics with 6GB of VRAM each. Mac Pro systems tested with an attached 5K display. Cinema 4D S24 real-time 3D performance tested using a 1.98GB scene. Performance tests are conducted using specific computer systems and reflect the approximate performance of Mac Pro and iMac Pro.
13. Testing conducted by Apple in July 2021 using shipping 2.5GHz 28-core Intel Xeon W-based Mac Pro systems with 384GB of RAM and preproduction dual AMD Radeon Pro W6800X Duo graphics with Infinity Fabric Link and 64GB of GDDR6 each; and production 2.3GHz 18-core Intel Xeon W-based 27-inch iMac Pro systems with 256GB of RAM and Radeon Pro Vega 64X graphics with 16GB of HBM2, as well as production 2.7GHz 12-core Intel Xeon E5-based Mac Pro systems with 64GB of RAM and dual AMD FirePro D700 graphics with 6GB of VRAM each. Mac Pro systems tested with an attached 5K display. Tested with DaVinci Resolve Studio 17 using 8 common effects and a 10-second UHD project at 3840x2160 resolution and 24 frames per second. Performance tests are conducted using specific computer systems and reflect the approximate performance of Mac Pro and iMac Pro.
14. Testing conducted by Apple in July 2021 using shipping 2.5GHz 28-core Intel Xeon W-based Mac Pro systems with 384GB of RAM and preproduction dual AMD Radeon Pro W6900X graphics with Infinity Fabric Link and 32GB of GDDR6 each, configured with Afterburner; and production 2.3GHz 18-core Intel Xeon W-based 27-inch iMac Pro systems with 256GB of RAM and Radeon Pro Vega 64X graphics with 16GB of HBM2, as well as production 2.7GHz 12-core Intel Xeon E5-based Mac Pro systems with 64GB of RAM and dual AMD FirePro D700 graphics with 6GB of VRAM each. Mac Pro systems tested with an attached 5K display. Final Cut Pro 10.5.4 tested using a complex 90-second project with a variety of media up to 8K resolution. Performance tests are conducted using specific computer systems and reflect the approximate performance of Mac Pro and iMac Pro.
15. Not available in all countries. Please refer to your country's AppleCare product website for specific information about rights provided by consumer law, AppleCare+ service fees, terms and conditions, and product purchase information.
16. Weight varies by configuration.

© 2021 Apple Inc. All rights reserved. Apple, the Apple logo, Apple Pencil, Boot Camp, Core ML, FaceTime, FileVault, Final Cut, Final Cut Pro, Finder, GarageBand, iMac, iMac Pro, iMovie, iPad, iPadOS, Keynote, Logic Pro, Mac, macOS, Mac Pro, Magic Keyboard, Magic Mouse, Magic Trackpad, Metal, Numbers, Pages, Photo Booth, QuickTime, Retina, Safari, and Xcode are trademarks of Apple Inc., registered in the U.S. and other countries. Find My and Sidecar are trademarks of Apple Inc. App Store, AppleCare, and iCloud are service marks of Apple Inc., registered in the U.S. and other countries. AppleCare+ is a service mark of Apple Inc. The Bluetooth® word mark and logos are registered trademarks owned by Bluetooth SIG, Inc. and any use of such marks by Apple is under license. Intel, Intel Core, and Xeon are trademarks of Intel Corp. in the U.S. and other countries. iOS is a trademark or registered trademark of Cisco in the U.S. and other countries and is used under license. Other product and company names mentioned herein may be trademarks of their respective companies. Product specifications are subject to change without notice. This material is provided for information purposes only; Apple assumes no liability related to its use. August 2021