

# Development of a Bolus Injection System to Achieve Storage and Controlled Delivery of Nanoparticles to Human Lung

V. Koujalagi, G.P.P. Gunarathne, S. Semple, J.G. Ayres.

**Abstract**—This paper presents work carried out in developing a precision, bolus injection system to study the effect of regional deposition of fine particulate matter (PM) within the human respiratory system and to investigate the optimal conditions for inhaled drug delivery. In contrast to existing methods, the new system computes parameters necessary and injects PM into breath cycles by a process of dynamic breath pattern analysis and statistical data relating to stored PM to achieve a highly controlled delivery within specified exposure times and intervals.

**Index Terms**— Air pollution, Bolus injection, Nanoparticles, Particulate matter, Respiratory disorders

## I. INTRODUCTION

Exposure to ambient air pollution is associated with health effects with increases in both mortality and morbidity on a day-to-day basis [1]. These effects are largely seen in patients with underlying cardio-pulmonary disease although why some individuals appear to be susceptible and others not have yet to be fully elucidated [2]. Also, it is known that different regions of the respiratory system respond differently to the deposition of PM and it is also affected by the presence of pre-existing lung disease. For example, there is a tendency for particles to be deposited more proximally in the lower respiratory tract in patients with bronchitis partly due to increased mucus hypersecretion and partly to airway narrowing [3].

Regional deposition may also be affected by the variation of breathing patterns, for instance, static measures of exposure in an individual working at a job which involves physical lifting requires the increased dose induced by the increased depth and

rate of respiration associated with physical effort.

A fundamental requirement in order to study the effect of regional deposition of various types of PM within the respiratory system is a precision PM bolus injection system which analyses the breath patterns and enables specified doses to be released at specified point in the breathing cycle. Here, an assumption is made that a bolus delivered early in inspiration is much more likely to deposit in the distal lung than one injected late in inspiration. Such a system would also enable the optimal release conditions for inhaled drug delivery to be studied.

## II. EXISTING METHODS

Human challenge studies have considered exposures to diluted diesel exhaust fume [4], to dehydrated aerosols (e.g. sulphuric acid) [5] and to generated particles with or without co-exposure to a specific pollutant gas. These exposures can either be done in a chamber, using a head-dome or through a mouth-piece from a dilution chamber or bag. Chambers are expensive and control of exposure is not so accurate while the mouth-piece approach tends to avoid nasal delivery which is less physiological than the normal situation. However, this approach is particularly useful if trying to understand accurate deposition of inhaled particle in the lower respiratory tract.

Following the latter approach, Kim [6] developed a bolus delivery system for delivering short pulses of particles during different phases of inspiration to try and determine deposition of particles by size in different parts of the lung. The system uses photometric methods to determine the difference between inhaled and exhaled concentrations of particles and assumes that the difference is deposited in the target site. This estimation is subjected to many possible errors including the likelihood of partial deposition occurring anywhere along the path due to impaction. Also, the system relies on the use of static or controlled breathing patterns and also requires the individual under test to trigger delivery and the target site selection appears to be carried out by manual means; thus falling short of practical requirements.

In contrast to the existing methods, the new system is designed to be fully automatic and programmable to take into account various clinical requirements in real situations. It also assumes preferential distal deposition based on the size and

Manuscript submitted on October 31, 2007, accepted on November 01, 2007.

V. Koujalagi was with the Department of Environmental and Occupational Medicine, University of Aberdeen, UK. He can now be contacted at vikasuk@gmail.com.

G. P. P. Gunarathne is with School of Engineering, The Robert Gordon University, UK (corresponding author, can be contacted at g.gunarathne@rgu.ac.uk)

S. Semple and J.G. Ayres are with the Department of Environmental and Occupational Medicine, University of Aberdeen, UK. They can be contacted at +44 (1224) 558188.

release time of the bolus but the calculations and parametric adjustments are carried out on a breath-by-breath basis by means of a real-time monitoring system, which takes into account factors such as breathing pattern, instantaneous lung volume and particulate concentration. Although the determination of the particulate concentration would be preferable using an on-line measurement system as in Kim's work, for simplicity, the present approach for achieving this was based on using statistical data relating to concentration and behaviour of PM received and stored in a chamber under pressure, before delivery.

These particles may be labelled using an appropriate radioactive isotope. The deposition site or the distribution may then be viewed using standard PET imaging techniques.

### III. BASIC SYSTEM

#### A. Functional requirements

The system has to comply with the following main end-user requirements.

1. Breath activation – the system should be able to detect the start of breathing cycle and activate the data acquisition and the control system.
2. Breath Pattern detection – Examine breath pattern histograms and identify the maximum ( $V_{\max}$ ) and minimum ( $V_{\min}$ ) lung volumes on the basis of a prescribed quantitative method, such as moving averages.
3. Programmable bolus size – Once programmed, the system should determine the parameters necessary to deliver the bolus as in equation (1), below.
4. Deliver a bolus of radioactive labelled aerosol at a selected point of the inhalation cycle.
5. Programmable site of deposition in the lung as determined by the time of release.

Graphically, the operation can be shown as in Fig. 1.

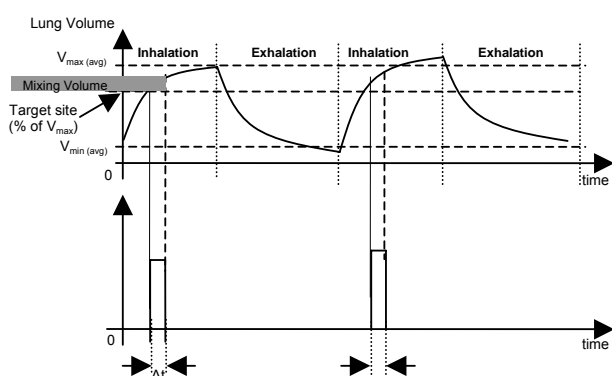

Fig. 1 Specified lung target (% of  $V_{\max}$  (avg) –  $V_{\min}$  (avg)) and bolus delivery period ( $\Delta t$ ) [7]

The desired dose  $W(\mu\text{g})$  of a bolus of PM may be written as:

$$W(\mu\text{g}) = \Delta w_{(T^0, t, p)} \times \Delta t \times n \quad (1)$$

where,  $\Delta w_{(T^0, t, p)}$  is the weight of the PM of a chosen size distribution, released during a time window of  $\Delta t$ ; and ( $n$ ) is the chosen number of breath cycles over which the total weight of the bolus is dispensed. The subscripts ( $T^0, t, p$ ) denote that  $\Delta w$  is dependent on the temperature, elapsed time of storage of the aerosol and the pressure ( $p$ ) at which the aerosol was stored. It is known that the particle concentration of a given size distribution of a stored sample of aerosol changes with time due to agglomeration, aggregation and settling. This changes the size distribution and the particulate concentration. Since the present method does not use a real-time device for measuring the particle concentration, the data relating to  $\Delta w_{(T^0, t, p)}$  has to be predetermined by experiment under prescribed conditions using a standard particle concentration metering system. Although these data have not been obtained fully, the system was designed on the basis of estimates until the experiments were completed. As can be seen from equation (1), given  $\Delta w_{(T^0, t, p)}$ ;  $\Delta t$  and ( $n$ ) could be used as system program inputs or derived variables to achieve the desired dosage.

#### B. System Description

Fig. 2 shows the main components of the system.

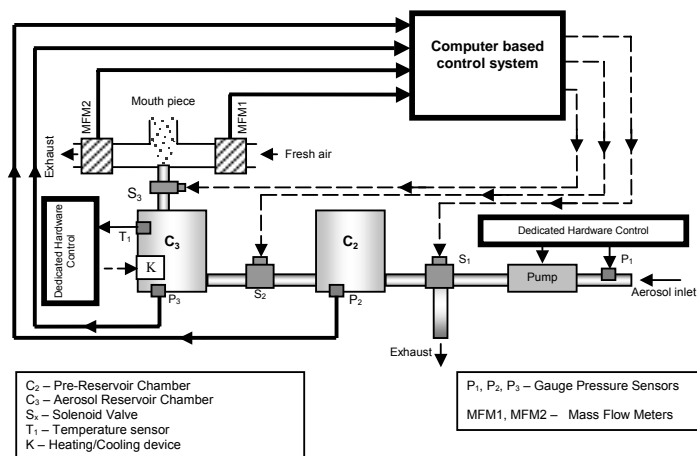

Fig. 2 Main components of the bolus injection system [7]

The main system is controlled by a computer based software control system. Some operations, which do not need user interaction and continuous monitoring, are controlled by dedicated hardware as shown in Fig. 2. Fig. 3 shows the system block diagram.

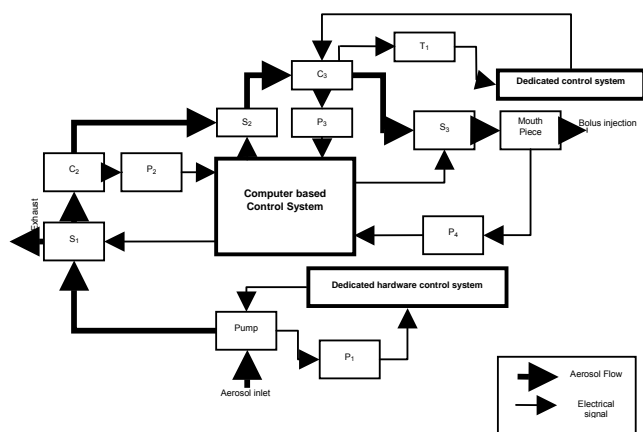

Fig. 3 System Block Diagram [7]

The main component of the system is the pressurised aerosol reservoir chamber  $C_3$ , which stores the nanoparticle aerosol to be delivered into the lung. The temperature and pressure in  $C_3$  are closely controlled. Pre-Reservoir Chamber  $C_2$  is maintained at a pressure higher than  $C_3$  so that when the pressure in  $C_3$  falls below a specified limit, it is quickly refreshed by opening the valve  $S_2$ . The nanoparticle aerosol itself is generated externally using a standard particle generator which is connected to the Aerosol inlet of the system. Valve  $S_1$  controls the flow of the aerosol to the chamber  $C_2$ , and in case of  $C_2$  reaching its maximum set pressure, bypasses the aerosol to exhaust.

Mass Flow Meters MFM1 and MFM2 are connected to the mouth-piece to detect inhalation and exhalation patterns respectively. The direction of air flow is controlled by two directional valves (not shown) connected one at each mass flow meters. The computer based control system reads values from the two mass flow meters to compute the instantaneous lung volumes. The site of deposition is determined as a set fraction of this volume to target the site of deposition specified by the user as a percentage of tidal volume ( $V_T$ ).

One of the new features is the method of priming, which is required before operation to either expel air within the chambers or to acquire a new sample. This would usually be a time consuming process. In this system, priming is achieved by cooling the inlet aerosol, such that it displaces the air or the previous sample within the chambers, thus achieving efficient priming within a short space of time.

The operation of the above control system is briefly described as follows:

#### C. Set-up stage:

1. Operation begins with powering up the pump, which starts pumping the incoming aerosol into the Pre-Reservoir chambers.

2. The computer based control system monitors the pressures in the chambers  $C_2$  and  $C_3$  continuously and opens/closes appropriate valves ( $S_1$  and  $S_2$  respectively) to maintain the specified pressures. Initially when  $C_2$  and  $C_3$  are at room pressure, the valves  $S_1$  and  $S_2$  will both be open.
3. Once  $C_3$  reaches the set pressure,  $S_2$  is closed.  $C_2$  continues to fill up until it reaches its set pressure (generally set greater than  $C_3$ ), after which the valve  $S_1$  is closed.  $S_1$  being a 3-way valve, redirects the aerosol to exhaust when closed. The exhaust aerosol flows through the filter chamber  $C_1$  (not shown) to filter the PM before the gas is let into the atmosphere.

#### D. Bolus delivery stage

1. The process of bolus delivery begins only after the pressure in  $C_3$  has reached the specified pressure.
2. The Computer based control system monitors the flow through the mass flow sensors MFM1 and MFM2.
3. MFM1 measures the breathing flow rate during inhalation and MFM2 during exhalation. The control system reads and scales the outputs of each sensor separately to get the equivalent flow rate, and then adds the two to obtain a single breathing curve.
4. The control system also uses the composite signal from step 3 to compute the lung volume by performing the operation of numerical integral.
5. Each time the breathing changes from inhalation to exhalation or vice versa, the instantaneous lung volume (calculated in step 4) are stored to give the  $V_{max}$  and  $V_{min}$  respectively.
6.  $V_{max}$  and  $V_{min}$  are averaged over  $N$  number of cycles (specified by user) to obtain an average tidal volume (the volume of each breath).
7. Bolus of aerosol from  $C_3$  is injected during inhalation by opening the valve  $S_3$ , presently for a fixed amount of time specified by the user. The actual site of deposition itself is calculated as a percent (specified) of the average  $V_T$  and the bolus is delivered when the instantaneous lung volume reaches this value.
8. Also during the bolus delivery stage, the control system monitors the pressures in the chambers  $C_2$  and  $C_3$  and opens/closes the appropriate solenoid valves as in step 3 of set-up stage to maintain storage pressure.

As can be seen from above description, there are a number of control sub-systems within the system. Apart from the dedicated hardware, the whole system is operated under software control, designed in LabVIEW Real-Time, running on a combination of 195MHz processor and FPGA based system. Fig. 4 shows the flowchart and Fig. 5 shows the LabVIEW code for the main program.

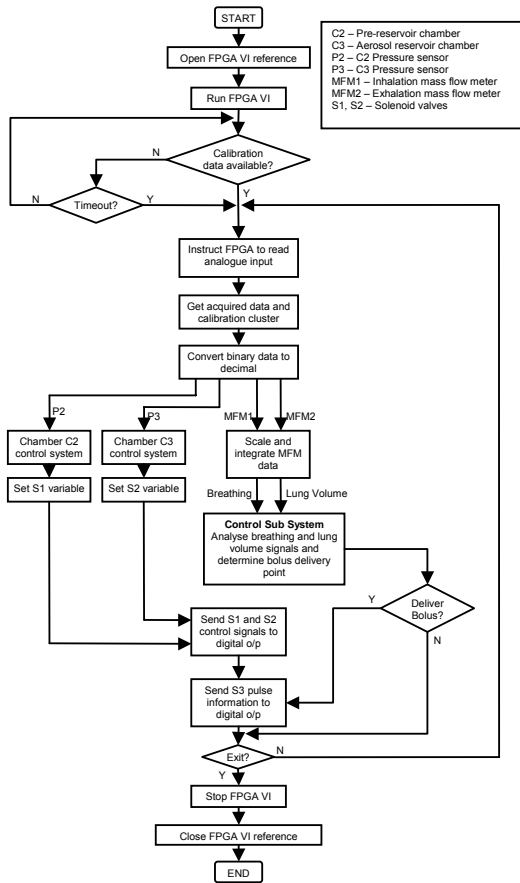

Fig 4 Flow chart for the main control system

IV. RESULTS

The main system has been assembled to allow testing to be carried out, although some of the experimental data required as mentioned under IIIB is being collected. In its present form, the system is capable of carrying out the intended control operations, i.e., C<sub>3</sub> pressure control, estimating and delivery operation functions, mentioned under IIIC. Fig. 6 shows the complete system

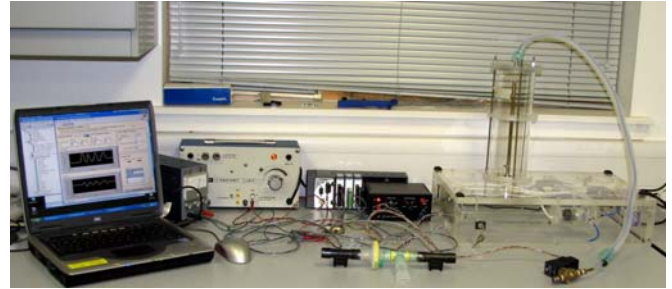

Fig. 6 Complete bolus delivery setup

Fig. 7 shows the main Graphical User Interface (GUI) of the system. The top graph shows the breathing pattern of a subject under test as computed by the system from the mass-flow rate information obtained from the sensors attached to the mouth piece. The raw sensory data is displayed in the lower graph.

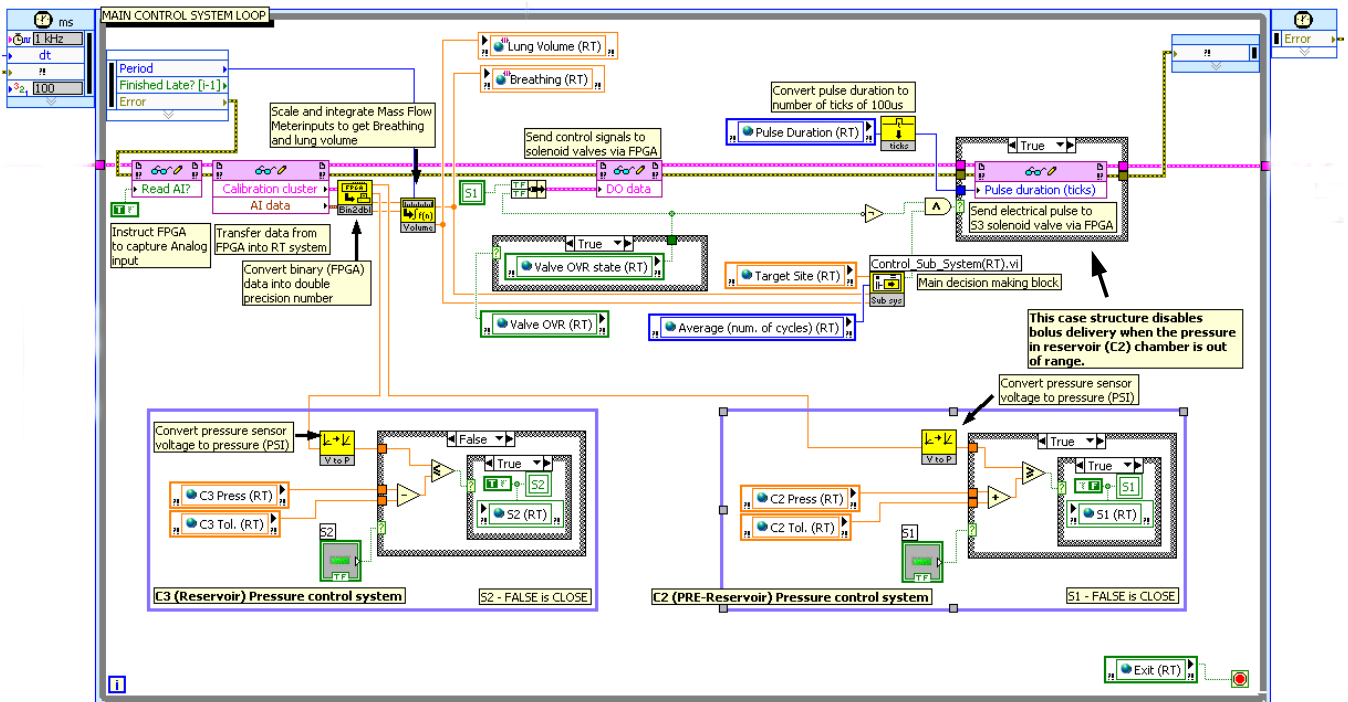

Fig 5 LabVIEW code for the main control system

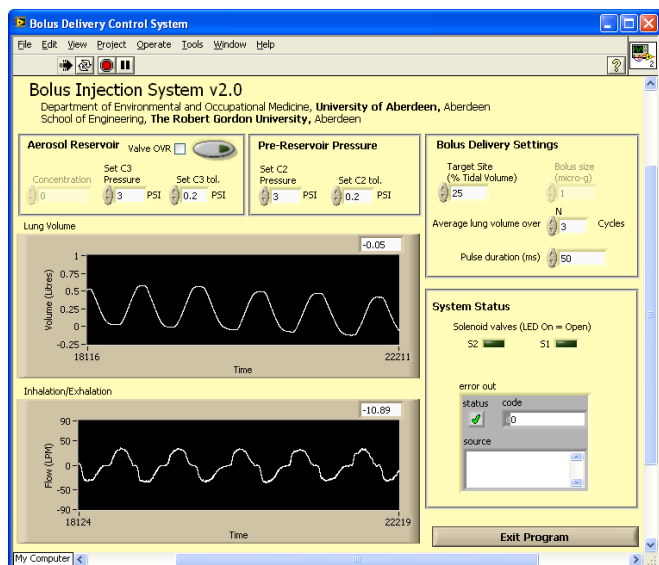

Fig. 7 Graphical User Interface

The operation of all the valves, temperature and pressure are also displayed in the GUI window, which also allows the user to specify set points on an interactive basis. The solenoid valves with the electronic drive circuits built into the assembly ensure fast response times and short bolus delivery duration of less than 10ms, thereby allowing high target-depth resolution to be achieved [8].

## V. DISCUSSION

### A. System improvements

Modification to the mouthpiece assembly was carried out to overcome errors caused by the non-laminar airflow through the exhalation Mass Flow Meter (MFM2). The check valve in the path of exhaled air, shown in Fig. 8, was identified to be causing the turbulence, which led to erroneous readings. A particulate filter was introduced between the check valve and the MFM, which smoothed the airflow, thereby reducing the errors.

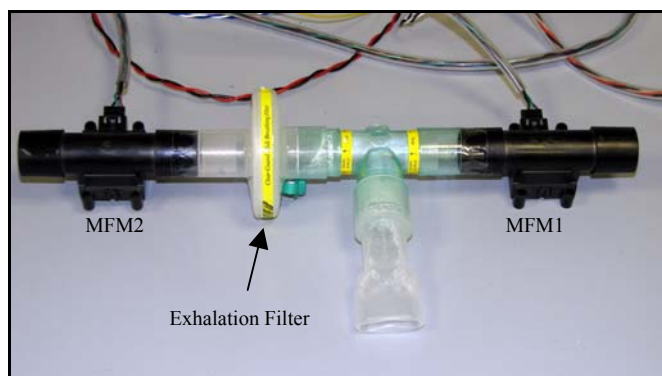
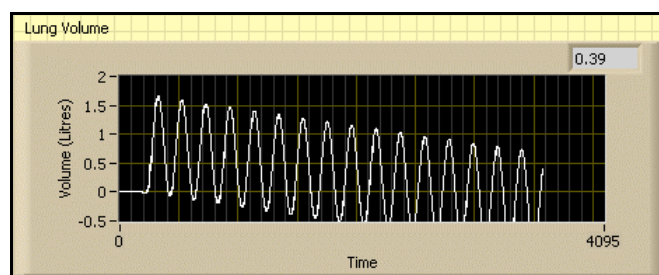

Fig. 8 Mouthpiece assembly with exhalation filter

Figs. 9 (a) and (b) show calculated lung volume with and

without the exhalation filter attached, respectively. A sinusoidal pump attached to the mouthpiece was used for the experiments.



(a)

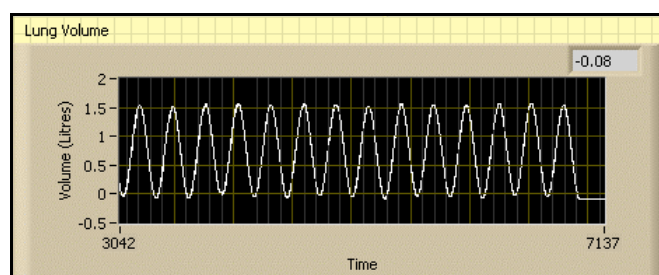

(b)

Fig. 9 Lung volume graphs (a) before and (b) after filter installation

Another requirement was to establish a re-setting integrator section in order to avoid drifts affecting measurement over longer periods. This has been achieved by implementing the following logic in the control system software.

- ⇒ Create an empty array with 2 elements. Initialise counter = 1 (i.e. no. of breathing cycles before reset).
- ⇒ If INHALATION phase begins, store the lung volume information in the above array; Decrement counter.
- ⇒ If EXHALATION phase begins:
  - If counter > 0, do nothing, continue.
  - If counter = 0, average values from array and add/subtract this from the Lung Volume. Reset counter = 1.

This has been demonstrated as illustrated in Fig. 10 below.

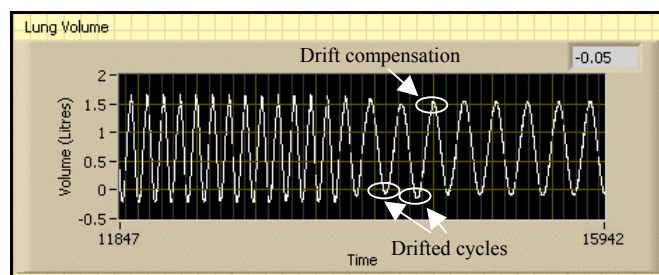
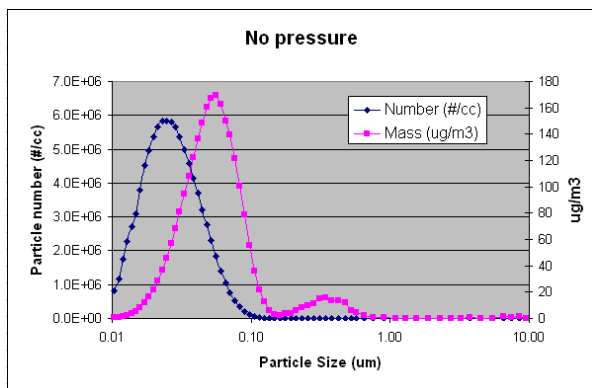

Fig. 10 Illustration of Integrator Reset function

### B. Aerosol Behaviour

Initial experiments on the behaviour of the nanoparticle aerosol with respect to circumstances such as the reservoir pressure and time of storage indicate, as predicted, that the particles start to aggregate/agglomerate almost immediately after they are generated. Fig. 11 shows the size distribution of (a) freshly generated aerosol, (b) aerosol stored under pressure in the reservoir at 3PSI for 2 minutes and (c) aerosol stored under pressure in the reservoir at 5PSI for 2 minutes.



(a)

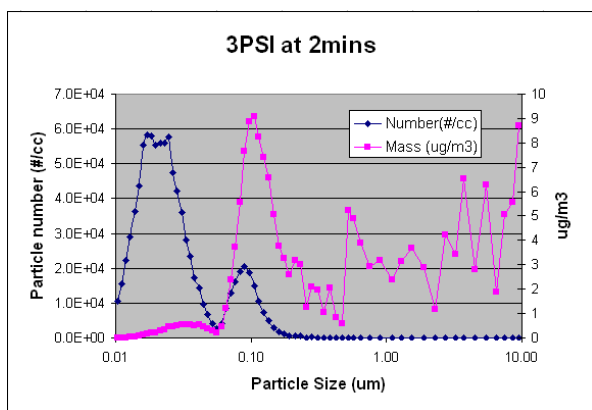

(b)

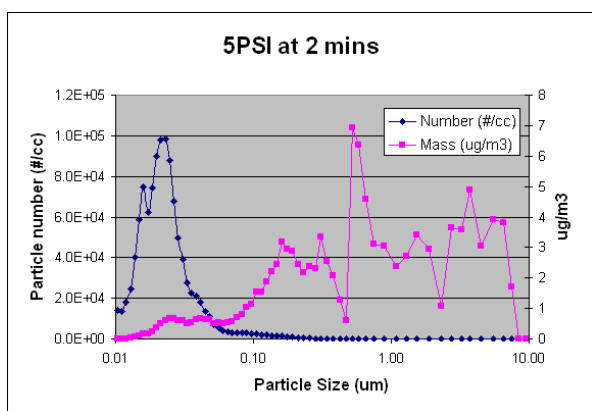

(c)

Fig. 11 Variation of nanoparticle properties with reservoir pressure

The variation in particle size distribution appears to be random, however, a large number of experiments across different variables should give indications of predictable behaviour of the nanoparticle aerosol. This work is currently being carried out.

### VI. CONCLUSIONS

An automated system for injecting prescribed doses of particulate matter at a selected point in the breathing cycle of a subject has been designed. The system monitors the breathing patterns before initiating delivery of the bolus and continuously estimates parameters necessary for the accurate determination of the delivery requirements, such as valve opening times according to particulate concentration and aerosol pressure.

A new priming technique by means of cooling inlet aerosol has also been successfully demonstrated, which enable clearing a previous sample from the storage chambers and using a new one within a short period of time. Electronic drive circuitry integrated into the valves ensures very short and precise actuation times to achieve high spatial resolution of target sites.

The system operation is controlled by a LabVIEW based dedicated real-time control system which also monitors and displays breathing patterns in terms of instantaneous lung volume and air flow rates providing additional diagnostic information.

Although the demonstration of the basic operation has been achieved, the completion of the system for clinical trials still requires experimental data relating to the behaviour of the different aerosols to be used, as described in IIIA. This work is in progress.

### ACKNOWLEDGMENT

This project is the result of a collaborative venture between the School of Engineering of the Robert Gordon University, UK and the Department of Environmental and Occupational Medicine of the University of Aberdeen, UK. Authors wish to express their gratitude to all those who helped facilitate this work.

### REFERENCES

- [1] J. Schwartz, "Air pollution and daily mortality": a review and meta analysis. *Environmental Research*. 1994, pp 64: 36-52.
- [2] H.M. Boezen, J.M. Vonk, S.C. Van der Zee, J. Gerritsen, G. Hoek, B. Brunekreef, J.P. Schouten, D.S. Postma, "Susceptibility to air pollution in elderly males and females", *European Respiratory Journal* 2005;25, pp1018-24.
- [3] R. Sturm, W. Hofmann, "Stochastic simulation of alveolar particle deposition in lungs affected by different types of emphysema", *J Aerosol Med: Deposition, Clearance, and Effects in the Lung*. 2004;1pp7:357-72
- [4] S.S. Salvi, C. Nordenhall, A. Blomberg, B. Rudell, J. Pourazar, F.J. Kelly, S. Wilson, T. Sandström, S.T. Holgate, A.J. Frew, "Acute exposure to

diesel exhaust increases IL-8 and GRO- $\alpha$  production in healthy human airways”, *Amer J Respir Crit Care Med* 2000;161:pp 550-7.

- [5] W.S. Tunnicliffe, D. Mark, J.G. Ayres, R.M. Harrison, “The effect of exposure to particulate sulphuric acid on the airway responses of mild atopic asthmatic subjects to inhaled grass pollen allergen”, *Eur Resp J* 2001;18:640-7.
- [6] C.S. Kim, S. C. Hu, P. DeWitt, T. R. Gerrity, “Assessment of regional deposition of inhaled particles in human lungs by serial bolus delivery method” *J. Appl. Physiol.* 1996;81: pp 2203–13.
- [7] V. Koujalagi, “Development of a New Method for the Study of Exposure to Nanoparticles within the Respiratory System in order to Better Define and Understand Health Risks”, *MSc Dissertation*, University of Aberdeen, December 2006.
- [8] G.P.P. Gunarathne, V. Koujalagi, S. Semple, J.G. Ayres, “A Breath-activated, Precision Bolus Injection System for Human Inhalation-exposure and Drug Delivery Studies” *Proceedings Book of The World Congress on Engineering* 2007;1:502–506.