

Automation of Reliability Assessment of Functional Elements of Flexible Automated Production Based on Functional Network Methodology

Evgeniy Lavrov¹[0000-0001-9117-5727], Nadiia Pasko²[0000-0002-9943-3775], Olga Siryk³[0000-0001-9360-4388], Volodymyr Mukoseev², Svitlana Dubovyk²

¹Sumy State University, Sumy, Ukraine

²Sumy National Agrarian University, Sumy, Ukraine

³Taras Shevchenko National University of Kyiv, Kyiv, Ukraine

prof_lavrov@hotmail.com, senabor64@ukr.com,
lavrova_olia@ukr.net, muksvn@gmail.com, dubovyksg@gmail.com,

Abstract. In the article, we propose to consider the reliability of flexible automated production and justify the need for functional decomposition of automated systems, followed by the description of processes in the form of functional networks. We have developed the principles of variant modeling for flexible production systems, the structure, and information and software of information technology for reliable design of automated production. The test proved the effectiveness of the proposed toolkit.

Keywords: Reliability, Flexible Manufacturing System, Ergonomics, Computer Modeling, Man-Machine, Algorithm of Functioning, Functional Network.

1 Introduction

Computerization and flexible control systems are becoming a trend of the modern stage of society development [1-4]. Flexible manufacturing radically changes the traditional, years-old approaches to production organization. Current technology, which is based on the differentiation of the process of machining parts for numerous operations and transitions performed on various machines, has lost its economic advantages, because production became much more complex and its range began to change more often. The essence of the concept of flexible automated production is that it allows you to switch from the release of one product to the release of another without reconfiguring the equipment or with the reconfiguration performed in parallel without stopping the release of the current product [5-8]. Unfortunately, the efficiency and reliability of flexible production systems (GPS) do not always meet current requirements in practice [1, 8].

2 Statement of the task

Unfortunately, the classical theory of reliability [10-14], methods of estimation and optimization of production systems [10, 15, 16], methods of estimation of reliability of operational personnel [17-19], do not have in their arsenal a complete library of models necessary for operative obtaining assessing the functional reliability of the processes occurring in the GPS.

In this regard, we aim to provide the possibility of prompt automated analysis of options (from the point of view of reliability) for organizing the operation processes in flexible manufacturing systems (FMS), taking into account the reliability of all structural elements and features of functional elements [6-9].

3 Results

3.1 Analysis of the functional structure of the FMS

For the normal operation of the FMS, a number of functional subsystems must be included in its composition. Among them:

- Warehouse module is an automatic warehouse, i.e. dispenser with an automatic search and transfer system to and from the warehouse, pallets, trays, etc. on vehicles.
- A transport module is a complex of automatic vehicles together with a system for automatically controlling the movement of these vehicles along a route.
- The installation module includes a set of equipment for the installation of workpieces into fixtures and pallets. (These three modules are combined into a transport and storage module).
- A tool module is an entire tool economy integrated into a tool management subsystem.
- The production module is the technological equipment that forms the FMS machine tool system.
- The test module consists of a quality control section, including CNC control and measuring machines, test benches, etc.
- ACS module is a complex of a central computer, intermediate mini-computers and microprocessors in conjunction with all the mathematical and software.

3.2 Development of principles for modeling the implementation of GPS function

Modeling and optimizing the operation of FMS becomes possible if you develop a technology based on the principles of:

- Functional decomposition (division of the process into separate functions - according to subsystems, as described above).

- A formalized description of all processes in the form of functional networks (FN) [8, 20-22] (unlike other network methods, for example [23, 24], they allow not only describing, but also evaluating and optimizing processes).
- Consideration of possible failures, malfunction of hardware and software, human operator errors, as well as modeling diagnostic processes, identifying errors and problem situations and restoring normal operation processes.
- Maintaining databases on the reliability of all structural elements (hardware, software, human operator).
- Maintaining databases of typical options for the implementation of functional structures (as in Fig. 1).
- Automatic analysis and calculation of the probability of error-free and the probability of timely implementation of alternative options for the organization of functioning.
- Taking into account the influence of individual characteristics of operators on the reliability of processes (including qualifications, motivation, workload, intensity of activity, category of work severity, etc.).
- Etc.

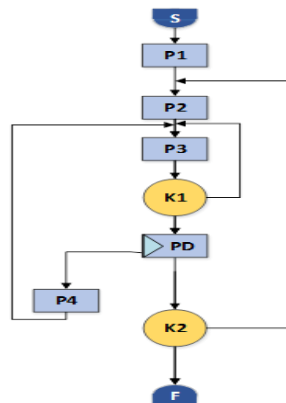

Fig. 1. A fragment of the description of the operation of the transport and storage system (symbols and composition of operations - see [20])

3.3 Description of information technology

Information technology (Fig. 2-7) provides:

- The accumulation of models necessary to obtain estimates of the probability of error-free and timely execution (for typical functional units (TFU) and typical functional structures (TFS));
- Accumulation of models of typical processes;
- Accumulation of input data for calculations;
- Automatic analysis of operational options;
- Automatic selection of the best option.

3.4 Testing

The developed system was used to design the functioning processes of flexible manufacturing sections of machining, as well as several other automated systems [8, 25-29].

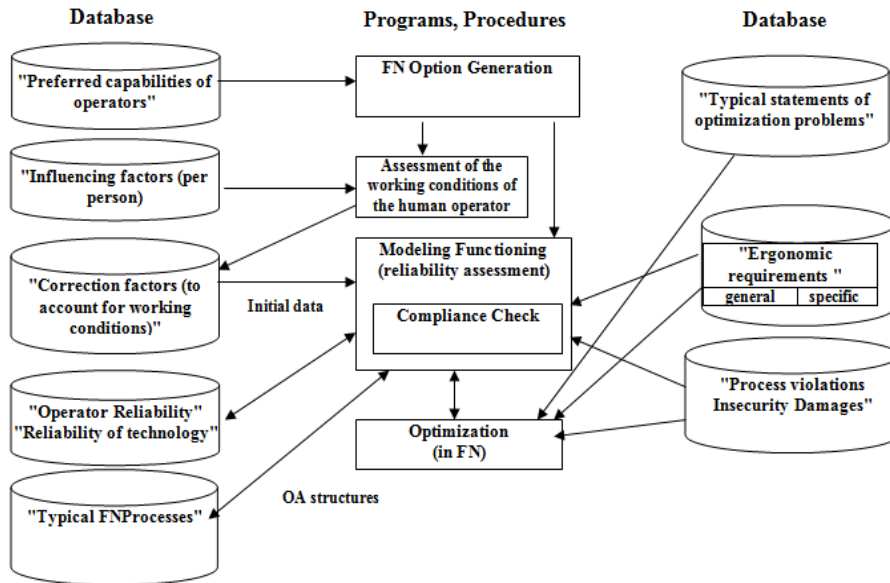

Fig. 2. A set of information and software automation tools for a reliable design of FMS

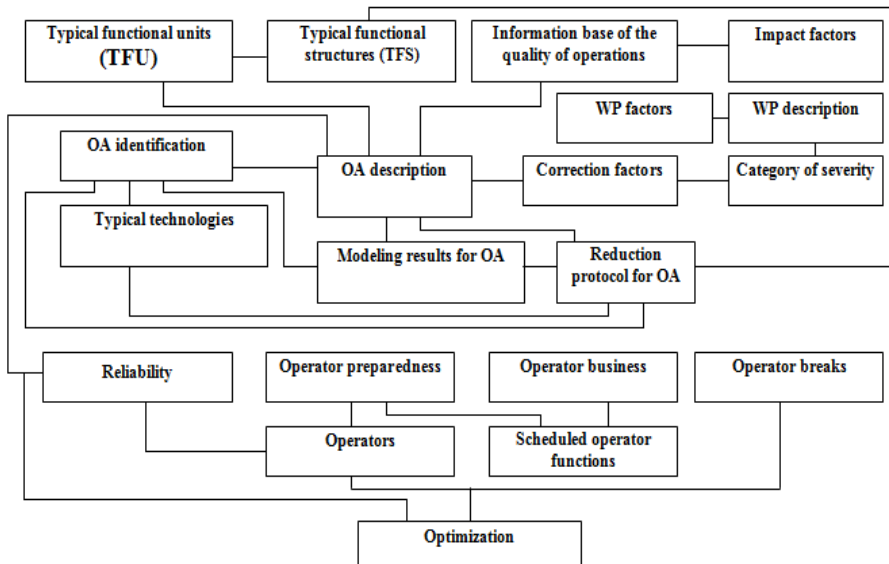

Fig. 3. Scheme of interconnections of tasks of the software package

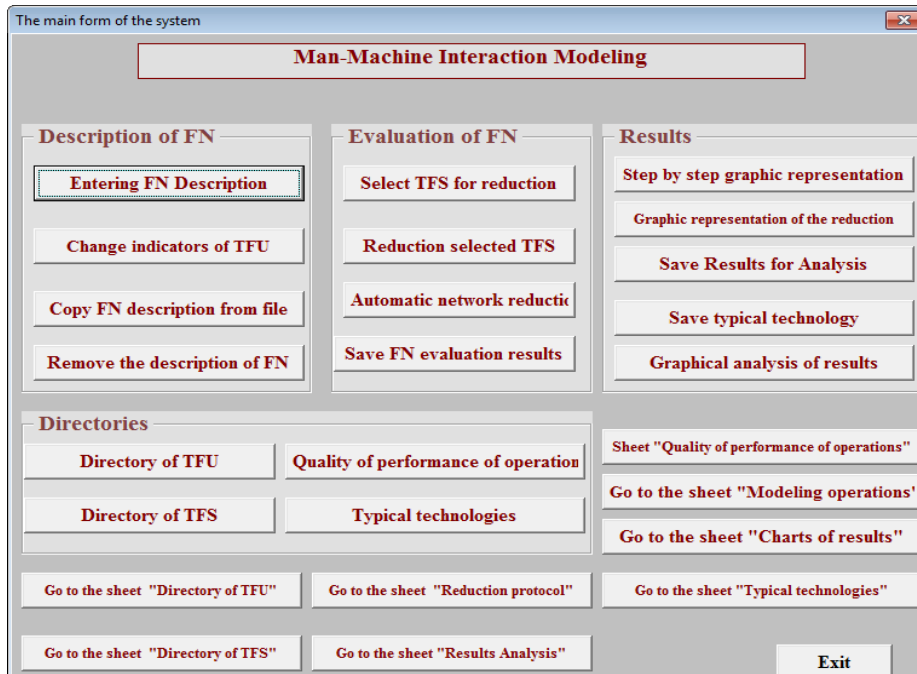

Fig. 4. The main form of the system

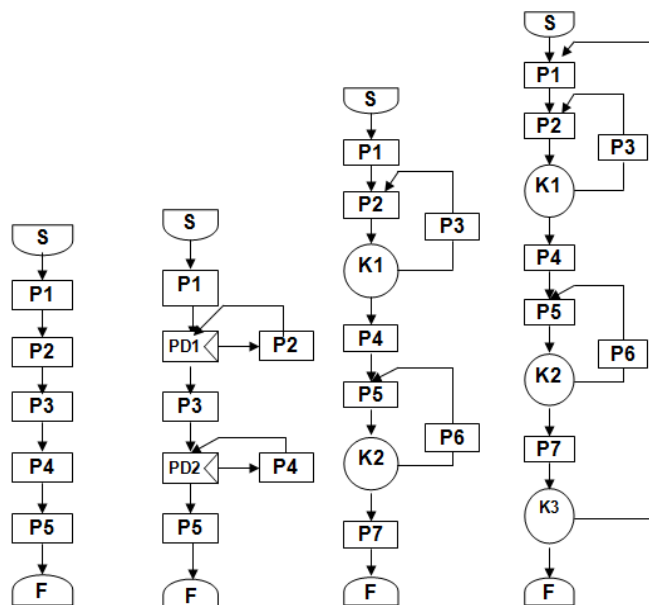

Fig. 5. Examples videogram of a computer program. Algorithm of the functioning of the robot manipulator. Variants of functional structures

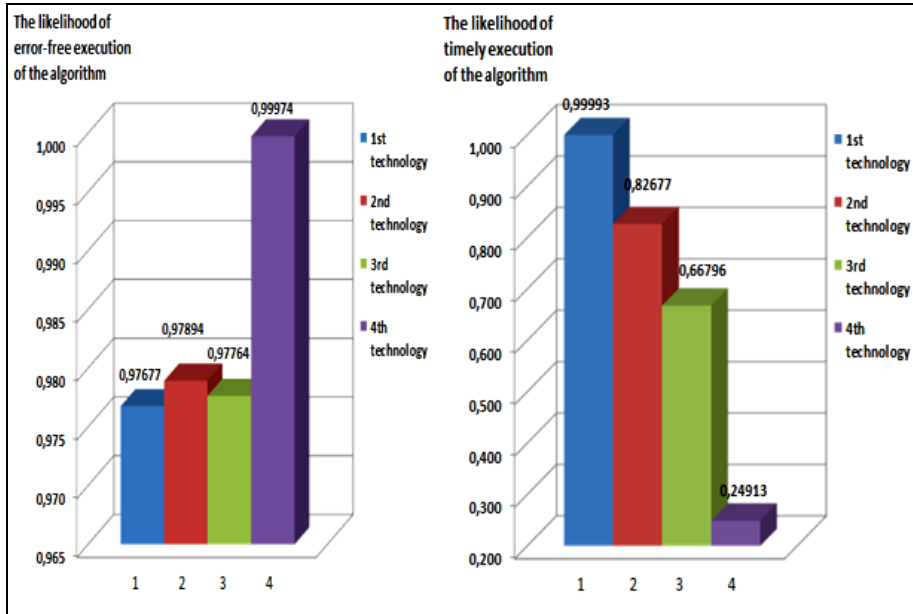

Fig. 6. Examples videogram of a computer program. Assessment results of the algorithms of the functioning of the robot manipulator

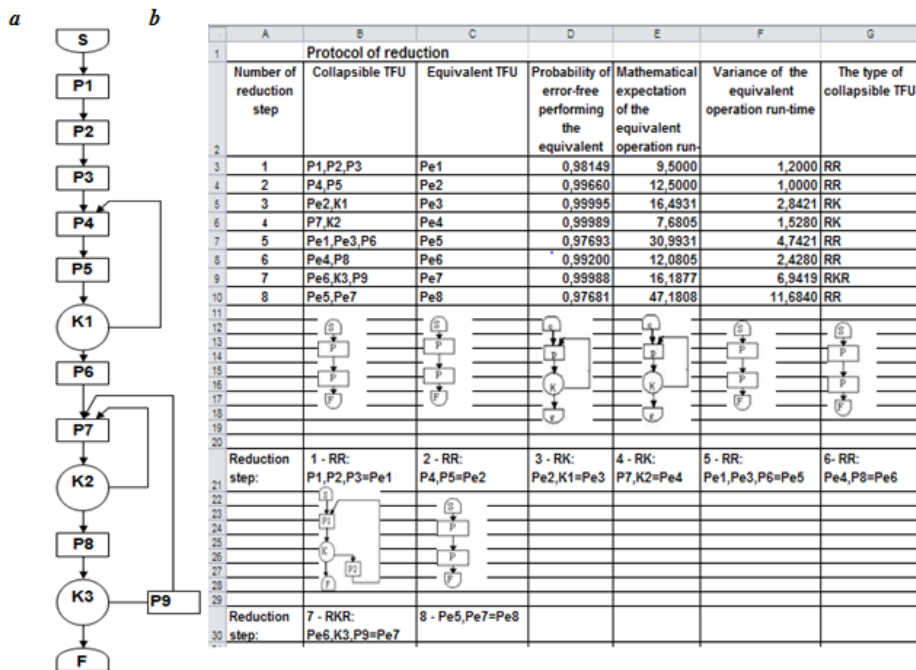

Fig. 7. Examples of videograms. Production module control algorithm: a - functional network; b - reduction report and evaluation result

4 Conclusion

The functional network provides modeling of production management processes, transport, warehouse operations, and preparation of control programs. It is a convenient tool for assessing the accuracy and timeliness of the implementation of FMS functions. The information technology developed on the principles of functional network reduction is a convenient tool for a variant analysis of automated control processes in FMS.

References

- [1] Zhong, R. Y., Xu, X., Klotz, E. et al.: Intelligent manufacturing in the context of industry 4.0: a review. *Engineering*, **3**(5), 616–630, (2017).
- [2] Sedov, V. A., Sedova, N. A. and Glushkov, S. V. : The fuzzy model of ships collision risk rating in a heavy traffic zone. *Vibroengineering PROCEEDIA*, **8**, 453–458, (2016).
- [3] Ogurtsov, E. S., Kokoreva, V. A., Ogurtsov, S. F., Usenbay, T. A., Kunesbekov, A. S. and Lavrov, E.A.: Microcontroller navigation and motion control system of the underwater robotic complex. *ARPN Journal of Engineering and Applied Sciences*, **11**(9), 3110–3121, (2016).
- [4] Verkhova, G. V. and Akimov, S. V.: Electronic educational complex for training specialists in the field of technical systems management. In *Proceedings of IEEE II International Conference on Control in Technical Systems (CTS)*, pp. 26–29, (2017).
- [5] Radziwon, A., Bilberg, A., Bogers M., and Madsen, E. S.: The smart factory: exploring adaptive and flexible manufacturing solutions. *Procedia Engineering*, **69**, 1184–1190, (2014).
- [6] Sawangsri, W., Suppasawat, P., Thamphanchark, V. and Pandey, S.: Novel Approach of an Intelligent and Flexible Manufacturing System: A Contribution to the Concept and Development of Smart Factory. In *2018 International Conference on System Science and Engineering (ICSSE)*, New Taipei, pp. 1–4, (2018). DOI: 10.1109/ICSSE.2018.8520029
- [7] Wang, S., Wan, J., Zhang D., Li, D. and Zhang, C.: Towards smart factory for industry 4.0: a self-organized multi-agent system with big data based feedback and coordination. *Computer Networks*, **101**, 158–168, (2016).
- [8] Lavrov, E., Pasko, N., Krivodub, A. and Tolbatov, A.: Mathematical models for the distribution of functions between the operators of the computer-integrated flexible manufacturing systems. In *2016 13th International Conference on Modern Problems of Radio Engineering, Telecommunications and Computer Science (TCSET)*, Lviv, pp. 72–75, (2016). DOI: 10.1109/TCSET.2016.7451974
- [9] Bihi, T., Luwes, N. and Kusakana, K.: Innovative Quality Management System for Flexible Manufacturing Systems. *2018 Open Innovations Conference (OI)*, Johannesburg, pp.40–46, (2018). DOI: 10.1109/OI.2018.8535610
- [10] Singh, K., Shroff, G. and Agarwal, P.: Predictive reliability mining for early warnings in populations of connected machines. In *2015 IEEE International Conference on Data Science and Advanced Analytics (DSAA)*, Paris, pp.1-10, (2015). DOI: 10.1109/DSAA.2015.7344806
- [11] Xu, D., Wei, Q., Chen, Y. and Kang, R.: Reliability Prediction Using Physics–Statistics-Based Degradation Model. In *IEEE Transactions on Components, Packaging and Manufacturing Technology*, **5**(11), pp. 1573-1581, (2015). DOI: 10.1109/TCPMT.2015.2483783
- [12] Wang, H., Li, R., Miao, J., Zhang, X. and Wang, Z.: Reliability-based design integrating system topology and structural components. In *2012 International Conference on Quality, Reliability, Risk, Maintenance, and Safety Engineering*, Chengdu, pp. 1167–1170, (2012). DOI:10.1109/ICQR2MSE.2012.6246428
- [13] Yunm, H., Kahirdeh, A., Christine, M. and Modarres, M.: Entropic Approach to Measure Damage with Applications to Fatigue Failure and Structural Reliability. In *2018 Annual Reliability and Maintainability Symposium (RAMS)*, Reno, NV, pp. 1–6. (2018). DOI: 10.1109/RAM.2018.8463066
- [14] Gasparyan, A. A. and Komarova, G. V.: Reliability assessment of a technical equipment complex of a monitoring system of parameters for electrical equipment taking into account reserve elements. *2018*

- IEEE Conference of Russian Young Researchers in Electrical and Electronic Engineering (EIconRus), Moscow, pp. 632–635, (2018). DOI: 10.1109/EIconRus.2018.8317176
- [15] Gai, C.: Design of Product Quality Process Control System Based on Fuzzy Logic. In 2018 International Conference on Virtual Reality and Intelligent Systems (ICVRIS), Changsha, pp. 335–338, (2018). DOI: 10.1109/ICVRIS.2018.00088
- [16] Phillips, C., Sandoval, J., Burton, T. and Jensen, D.: Designing factory support equipment for field use. In 2015 IEEE AUTOTESTCON, National Harbor, MD, pp. 15–18, (2015). DOI:10.1109/AUTEST.2015.7356459
- [17] Di Pasquale, V., Franciosi, C., Lambiase, A. and Miranda, S.: Methodology for the analysis and quantification of human error probability in manufacturing systems. In 2016 IEEE Student Conference on Research and Development (SCOREd), Kuala Lumpur, pp. 1–5, (2016). DOI:10.1109/SCORED.2016.7810093
- [18] Rothmorea, P., Aylwardb, P. and Karnona, J.: The implementation of ergonomics advice and the stage of change approach. *Applied Ergonomics*, **51**, 370–376, (2015). DOI: 10.1016/j.apergo.2015.06.013
- [19] Cacciabue, P.C.: Human error risk management for engineering systems: a methodology for design, safety assessment, accident investigation and training. *Reliability Engineering & System Safety*, **83**(2), 229–269, (2014). DOI: 10.1016/j.res.2003.09.013
- [20] Adamenko, A.N., Asherov, A.T., Berdnikov, I. L. et al.: Information controlling human-machine systems: research, design, testing. Reference book. A.I. Gubinsky & V.G. Evgrafov, eds. Moscow, Russia: Mashinostroenie, 1993. (In Russian).
- [21] Chabankenko, P.P.: Research of the safety and efficiency of the functioning of systems “human – technics” by ergonomic networks. Sevastopol, Ukraine: Academy of naval forces named after P. S. Nahimov, 2012. (In Russian).
- [22] Grif, M. G., Sundui, O. and Tsoy, E. B.: Methods of desingning and modeling of man–machine systems. In Proc. of International Summer workshop Computer Science, pp. 38–40, (2014).
- [23] Drakaki, M. and Tzionas, P.: Manufacturing Scheduling Using Colored Petri Nets and Reinforcement Learning. *Applied Sciences*, **7**(2), p. 136, (2017). DOI:10.3390/app7020136
- [24] Farah, K., Chabir, K. and Abdelkrim, M. N.: Colored Petri nets for modeling of networked control systems. In 2019 19th International Conference on Sciences and Techniques of Automatic Control and Computer Engineering (STA), Sousse, Tunisia, pp. 226–230, (2019). DOI:10.1109/STA.2019.8717215
- [25] Lavrov, E., Pasko, N., Kozhevnykov, G., Gonchar, V. and Mukoseev, V.: Improvement for Ergonomic Quality of Man-Machine Interaction in Automated Systems based on the Optimization Model. In 2018 International Scientific-Practical Conference Problems of Infocommunications. Science and Technology (PICS&T-2018), Kharkiv, Ukraine, pp. 735–740, (2018). DOI:10.1109/INFOCOMMST.2018.8632074
- [26] Lavrov, E., Pasko, N., Paderno, P., Volosiuk, A. and Kyzenko, V.: Decision Support Method for Ensuring Ergonomic Quality in Polyergatic IT Resource Management Centers. In 2019 IEEE III International Conference on Control in Technical Systems (CTS), St. Petersburg, pp. 153–156. (2019). DOI: 10.1109/CTS48763.2019.8973265
- [27] Lavrov, E., Volosiuk, A., Pasko, N., Gonchar, V. and Kozhevnikov, G.: Computer Simulation of Discrete Human-Machine Interaction for Providing Reliability and Cyber-security of Critical Systems. In Proceedings of the Third International Conference Ergo-2018: Human Factors in Complex Technical Systems and Environments (Ergo-2018) July 4 – 7, 2018, St. Petersburg, Russia, pp. 67–70, (2018). DOI:10.1109/ERGO.2018.8443846
- [28] Lavrov, E., Pasko, N., Tolbatov, A. and Tolbatov, V.: Cybersecurity of distributed information systems. The minimization of damage caused by errors of operators during group activity. In Proceedings of 2nd International Conference on Advanced Information and Communication Technologies-2017 (AICT-2017), pp. 83–87, (2017). DOI:10.1109/AIACT.2017.8020071
- [29] Lavrov, E., Pasko, N. and Borovyk, V.: Management for the operators activity in the polyergatic system. Method of functions distribution on the basis of the reliability model of system states. In Proceedings of International Scientific and Practical Conference “Problems of Infocommunications. Science and Technology (PICS&T-2018), pp. 423–429, (2018). DOI:10.1109/INFOCOMMST.2018.8632102