

ETSI TS 136 211 V16.2.0 (2020-09)



**LTE;
Evolved Universal Terrestrial Radio Access (E-UTRA);
Physical channels and modulation
(3GPP TS 36.211 version 16.2.0 Release 16)**



Reference

RTS/TSGR-0136211vg20

Keywords

LTE

ETSI

650 Route des Lucioles
F-06921 Sophia Antipolis Cedex - FRANCE

Tel.: +33 4 92 94 42 00 Fax: +33 4 93 65 47 16

Siret N° 348 623 562 00017 - NAF 742 C
Association à but non lucratif enregistrée à la
Sous-Préfecture de Grasse (06) N° 7803/88

Important notice

The present document can be downloaded from:

<http://www.etsi.org/standards-search>

The present document may be made available in electronic versions and/or in print. The content of any electronic and/or print versions of the present document shall not be modified without the prior written authorization of ETSI. In case of any existing or perceived difference in contents between such versions and/or in print, the prevailing version of an ETSI deliverable is the one made publicly available in PDF format at www.etsi.org/deliver.

Users of the present document should be aware that the document may be subject to revision or change of status.

Information on the current status of this and other ETSI documents is available at

<https://portal.etsi.org/TB/ETSIDeliverableStatus.aspx>

If you find errors in the present document, please send your comment to one of the following services:

<https://portal.etsi.org/People/CommiteeSupportStaff.aspx>

Copyright Notification

No part may be reproduced or utilized in any form or by any means, electronic or mechanical, including photocopying and microfilm except as authorized by written permission of ETSI.

The content of the PDF version shall not be modified without the written authorization of ETSI.

The copyright and the foregoing restriction extend to reproduction in all media.

© ETSI 2020.

All rights reserved.

DECT™, **PLUGTESTS™**, **UMTS™** and the ETSI logo are trademarks of ETSI registered for the benefit of its Members.

3GPP™ and **LTE™** are trademarks of ETSI registered for the benefit of its Members and of the 3GPP Organizational Partners.

oneM2M™ logo is a trademark of ETSI registered for the benefit of its Members and of the oneM2M Partners.

GSM® and the GSM logo are trademarks registered and owned by the GSM Association.

Intellectual Property Rights

Essential patents

IPRs essential or potentially essential to normative deliverables may have been declared to ETSI. The information pertaining to these essential IPRs, if any, is publicly available for **ETSI members and non-members**, and can be found in ETSI SR 000 314: "*Intellectual Property Rights (IPRs); Essential, or potentially Essential, IPRs notified to ETSI in respect of ETSI standards*", which is available from the ETSI Secretariat. Latest updates are available on the ETSI Web server (<https://ipr.etsi.org/>).

Pursuant to the ETSI IPR Policy, no investigation, including IPR searches, has been carried out by ETSI. No guarantee can be given as to the existence of other IPRs not referenced in ETSI SR 000 314 (or the updates on the ETSI Web server) which are, or may be, or may become, essential to the present document.

Trademarks

The present document may include trademarks and/or tradenames which are asserted and/or registered by their owners. ETSI claims no ownership of these except for any which are indicated as being the property of ETSI, and conveys no right to use or reproduce any trademark and/or tradename. Mention of those trademarks in the present document does not constitute an endorsement by ETSI of products, services or organizations associated with those trademarks.

Legal notice

This Technical Specification (TS) has been produced by the ETSI 3rd Generation Partnership Project (3GPP).

The present document may refer to technical specifications or reports using their 3GPP identities. These shall be interpreted as being references to the corresponding ETSI deliverables.

The cross reference between 3GPP and ETSI identities can be found under <http://webapp.etsi.org/key/queryform.asp>.

Modal verbs terminology

In the present document "**shall**", "**shall not**", "**should**", "**should not**", "**may**", "**need not**", "**will**", "**will not**", "**can**" and "**cannot**" are to be interpreted as described in clause 3.2 of the [ETSI Drafting Rules](#) (Verbal forms for the expression of provisions).

"**must**" and "**must not**" are **NOT** allowed in ETSI deliverables except when used in direct citation.

Contents

Intellectual Property Rights	2
Legal notice	2
Modal verbs terminology.....	2
Foreword.....	9
1 Scope	10
2 References	10
3 Symbols and abbreviations.....	11
3.1 Symbols.....	11
3.2 Abbreviations	15
4 Frame structure.....	15
4.1 Frame structure type 1	16
4.2 Frame structure type 2.....	17
4.3 Frame structure type 3.....	18
5 Uplink.....	20
5.1 Overview	20
5.1.1 Physical channels.....	20
5.1.2 Physical signals.....	20
5.2 Slot structure and physical resources.....	20
5.2.1 Resource grid	20
5.2.2 Resource elements	22
5.2.3 Resource blocks	22
5.2.4 Narrowbands and widebands	22
5.2.5 Guard period for narrowband and wideband retuning	23
5.3 Physical uplink shared channel	25
5.3.1 Scrambling.....	25
5.3.2 Modulation.....	26
5.3.2A Layer mapping	27
5.3.2A.1 Layer mapping for transmission on a single antenna port.....	27
5.3.2A.2 Layer mapping for spatial multiplexing	27
5.3.3 Transform precoding.....	28
5.3.3A Precoding	28
5.3.3A.1 Precoding for transmission on a single antenna port.....	28
5.3.3A.2 Precoding for spatial multiplexing	28
5.3.4 Mapping to physical resources.....	31
5.4 Physical uplink control channel.....	37
5.4.1 PUCCH formats 1, 1a and 1b	38
5.4.2 PUCCH formats 2, 2a and 2b	41
5.4.2A PUCCH format 3	42
5.4.2B PUCCH format 4	44
5.4.2C PUCCH format 5	44
5.4.3 Mapping to physical resources.....	45
5.4A Short Physical Uplink Control Channel	48
5.4A.1 General.....	48
5.4A.2 SPUCCH formats 1,1a,1b.....	48
5.4A.2.1 Slot-SPUCCH	48
5.4A.2.2 Subslot-SPUCCH.....	49
5.4A.3 SPUCCH format 3	50
5.4A.3.1 Slot-SPUCCH	50
5.4A.4 SPUCCH format 4	50
5.4A.4.1 Slot-SPUCCH	50
5.4A.4.2 Subslot-SPUCCH.....	51
5.4A.5 Mapping to physical resources.....	51
5.5 Reference signals.....	55

5.5.1	Generation of the reference signal sequence.....	55
5.5.1.1	Base sequences of length $3N_{sc}^{RB}$ or larger	56
5.5.1.2	Base sequences of length less than $3N_{sc}^{RB}$	57
5.5.1.3	Group hopping	61
5.5.1.4	Sequence hopping	62
5.5.1.5	Determining virtual cell identity for sequence generation	62
5.5.2	Demodulation reference signal	63
5.5.2.1	Demodulation reference signal for PUSCH	63
5.5.2.1.1	Reference signal sequence.....	63
5.5.2.1.2	Mapping to physical resources	67
5.5.2.1A	Demodulation reference signal for PUSCH with sub-PRB allocations.....	68
5.5.2.1A.1	Reference signal sequence using modulation schemes other than $\pi/2$ -BPSK	68
5.5.2.1A.2	Reference signal sequence using $\pi/2$ -BPSK modulation scheme.....	69
5.5.2.1A.3	Group hopping.....	70
5.5.2.1A.4	Mapping to physical resources	71
5.5.2.2	Demodulation reference signal for PUCCH.....	71
5.5.2.2.1	Reference signal sequence.....	71
5.5.2.2.2	Mapping to physical resources	73
5.5.2.3	Demodulation reference signal for SPUCCH.....	74
5.5.2.3.1	Reference signal sequence.....	74
5.5.2.3.2	Mapping to physical resources	75
5.5.3	Sounding reference signal.....	76
5.5.3.1	Sequence generation.....	76
5.5.3.1.1	Sequence generation for basic SRS	76
5.5.3.1.2	Sequence generation for additional SRS	76
5.5.3.2	Mapping to physical resources	77
5.5.3.2.1	Mapping to physical resources for basic SRS	77
5.5.3.2.2	Mapping to physical resources for additional SRS.....	79
5.5.3.3	Sounding reference signal subframe configuration	80
5.6	SC-FDMA baseband signal generation	82
5.6A	SC-FDMA baseband signal generation for PUSCH using sub-PRB allocations.....	83
5.6A.1	Modulation schemes other than $\pi/2$ -BPSK.....	83
5.6A.2	Modulation scheme $\pi/2$ -BPSK	83
5.7	Physical random access channel.....	84
5.7.1	Time and frequency structure	84
5.7.2	Preamble sequence generation.....	91
5.7.3	Baseband signal generation.....	96
5.8	Modulation and upconversion	97
6	Downlink.....	98
6.1	Overview	98
6.1.1	Physical channels.....	98
6.1.2	Physical signals.....	98
6.2	Slot structure and physical resource elements	99
6.2.1	Resource grid.....	99
6.2.2	Resource elements	100
6.2.3	Resource blocks	101
6.2.3.1	Virtual resource blocks of localized type	102
6.2.3.2	Virtual resource blocks of distributed type	102
6.2.4	Resource-element groups (REGs).....	103
6.2.4A	Enhanced Resource-Element Groups (EREGs).....	104
6.2.4B	Short Resource-Element Groups (SREGs)	104
6.2.5	Guard period for half-duplex FDD operation	104
6.2.6	Guard Period for TDD Operation	105
6.2.7	Narrowbands and widebands	105
6.2.8	Guard period for narrowband and wideband retuning	106
6.3	General structure for downlink physical channels.....	106
6.3.1	Scrambling.....	107
6.3.2	Modulation.....	108
6.3.3	Layer mapping	108
6.3.3.1	Layer mapping for transmission on a single antenna port.....	108

6.3.3.2	Layer mapping for spatial multiplexing	109
6.3.3.3	Layer mapping for transmit diversity	110
6.3.4	Precoding	110
6.3.4.1	Precoding for transmission on a single antenna port	110
6.3.4.2	Precoding for spatial multiplexing using antenna ports with cell-specific reference signals	111
6.3.4.2.1	Precoding without CDD	111
6.3.4.2.2	Precoding for large delay CDD	111
6.3.4.2.3	Codebook for precoding and CSI reporting	112
6.3.4.3	Precoding for transmit diversity	113
6.3.4.4	Precoding for spatial multiplexing using antenna ports with UE-specific reference signals	114
6.3.5	Mapping to resource elements	115
6.4	Physical downlink shared channel	116
6.4.1	Physical downlink shared channel for BL/CE UEs	118
6.4.2	Slot/subslot-based physical downlink shared channel	121
6.5	Physical multicast channel	123
6.6	Physical broadcast channel	123
6.6.1	Scrambling	123
6.6.2	Modulation	123
6.6.3	Layer mapping and precoding	124
6.6.4	Mapping to resource elements	124
6.6.4.1	PBCH repetition in the cell acquisition subframe	125
6.7	Physical control format indicator channel	126
6.7.1	Scrambling	126
6.7.2	Modulation	126
6.7.3	Layer mapping and precoding	127
6.7.4	Mapping to resource elements	127
6.8	Physical downlink control channel	127
6.8.1	PDCCH formats	127
6.8.2	PDCCH multiplexing and scrambling	127
6.8.3	Modulation	128
6.8.4	Layer mapping and precoding	128
6.8.5	Mapping to resource elements	128
6.8A	Enhanced physical downlink control channel	129
6.8A.1	EPDCCH formats	130
6.8A.2	Scrambling	131
6.8A.3	Modulation	131
6.8A.4	Layer mapping and precoding	131
6.8A.5	Mapping to resource elements	132
6.8B	MTC physical downlink control channel	133
6.8B.1	MPDCCH formats	133
6.8B.2	Scrambling	134
6.8B.3	Modulation	134
6.8B.4	Layer mapping and precoding	134
6.8B.5	Mapping to resource elements	134
6.8C	Short physical downlink control channel (SPDCCH)	138
6.8C.1	SPDCCH formats	138
6.8C.2	Scrambling	140
6.8C.3	Modulation	140
6.8C.4	Layer mapping and precoding	140
6.8C.5	Mapping to resource elements	140
6.9	Physical hybrid ARQ indicator channel	142
6.9.1	Modulation	143
6.9.2	Resource group alignment, layer mapping and precoding	143
6.9.3	Mapping to resource elements	145
6.10	Reference signals	147
6.10.1	Cell-specific Reference Signal (CRS)	147
6.10.1.1	Sequence generation	147
6.10.1.2	Mapping to resource elements	148
6.10.2	MBSFN reference signals	150
6.10.2.1	Sequence generation	150
6.10.2.1.1	Sequence generation for 15 kHz and 7.5 kHz subcarrier spacing	150
6.10.2.1.2	Sequence generation for 1.25 kHz subcarrier spacing	151

6.10.2.1.3	Sequence generation for 2.5 kHz subcarrier spacing.....	151
6.10.2.1.4	Sequence generation for 0.37 kHz subcarrier spacing.....	151
6.10.2.2	Mapping to resource elements.....	151
6.10.2.2.1	Mapping to resource elements for 15 kHz and 7.5 kHz subcarrier spacing	151
6.10.2.2.2	Mapping to resource elements for 1.25 kHz.....	153
6.10.2.2.3	Mapping to resource elements for 2.5 kHz subcarrier spacing.....	153
6.10.2.2.4	Mapping to resource elements for 0.37 kHz subcarrier spacing.....	154
6.10.3	UE-specific reference signals associated with PDSCH	154
6.10.3.1	Sequence generation.....	155
6.10.3.2	Mapping to resource elements.....	156
6.10.3A	Demodulation reference signals associated with EPDCCH, MPDCCH, or SPDCCH	163
6.10.3A.1	Sequence generation.....	164
6.10.3A.2	Mapping to resource elements.....	165
6.10.4	Positioning reference signals	167
6.10.4.1	Sequence generation.....	167
6.10.4.2	Mapping to resource elements.....	167
6.10.4.3	Positioning reference signal subframe configuration	169
6.10.5	CSI reference signals	170
6.10.5.1	Sequence generation.....	171
6.10.5.2	Mapping to resource elements.....	171
6.10.5.3	CSI reference signal subframe configuration	180
6.11	Synchronization signals.....	180
6.11.1	Primary synchronization signal (PSS)	180
6.11.1.1	Sequence generation.....	180
6.11.1.2	Mapping to resource elements.....	181
6.11.2	Secondary synchronization signal (SSS)	181
6.11.2.1	Sequence generation.....	181
6.11.2.2	Mapping to resource elements.....	183
6.11.3	Resynchronization signal (RSS)	184
6.11.3.1	Sequence generation.....	184
6.11.3.2	Mapping to resource elements.....	184
6.11A	Discovery signal.....	185
6.11B	MTC wake-up signal (MWUS).....	186
6.11B.1	Sequence generation	186
6.11B.2	Mapping to resource elements	186
6.12	OFDM baseband signal generation	187
6.13	Modulation and upconversion	187
7	Generic functions	189
7.1	Modulation mapper	189
7.1.1	BPSK	189
7.1.2	QPSK	189
7.1.3	16QAM.....	189
7.1.4	64QAM.....	190
7.1.5	256QAM.....	192
7.1.6	1024QAM.....	193
7.2	Pseudo-random sequence generation.....	193
8	Timing.....	193
8.1	Uplink-downlink frame timing.....	193
9	Sidelink.....	195
9.1	Overview	195
9.1.1	Physical channels.....	195
9.1.2	Physical signals.....	195
9.1.3	Handling of simultaneous sidelink and uplink/downlink transmissions	195
9.2	Slot structure and physical resources.....	196
9.2.1	Resource grid.....	196
9.2.2	Resource elements	196
9.2.3	Resource blocks	197
9.2.4	Resource pool	197
9.2.5	Guard period	197
9.3	Physical Sidelink Shared Channel.....	197

9.3.1	Scrambling.....	197
9.3.2	Modulation.....	198
9.3.3	Layer mapping.....	198
9.3.4	Transform precoding.....	198
9.3.5	Precoding.....	198
9.3.6	Mapping to physical resources.....	198
9.4	Physical Sidelink Control Channel.....	199
9.4.1	Scrambling.....	199
9.4.2	Modulation.....	199
9.4.3	Layer mapping.....	199
9.4.4	Transform precoding.....	199
9.4.5	Precoding.....	199
9.4.6	Mapping to physical resources.....	199
9.5	Physical Sidelink Discovery Channel.....	200
9.5.1	Scrambling.....	200
9.5.2	Modulation.....	200
9.5.3	Layer mapping.....	200
9.5.4	Transform precoding.....	200
9.5.5	Precoding.....	200
9.5.6	Mapping to physical resources.....	200
9.6	Physical Sidelink Broadcast Channel.....	201
9.6.1	Scrambling.....	201
9.6.2	Modulation.....	201
9.6.3	Layer mapping.....	201
9.6.4	Transform precoding.....	201
9.6.5	Precoding.....	201
9.6.6	Mapping to physical resources.....	201
9.7	Sidelink Synchronization Signals.....	201
9.7.1	Primary sidelink synchronization signal.....	202
9.7.1.1	Sequence generation.....	202
9.7.1.2	Mapping to resource elements.....	202
9.7.2	Secondary sidelink synchronization signal.....	202
9.7.2.1	Sequence generation.....	202
9.7.2.2	Mapping to resource elements.....	202
9.8	Demodulation reference signals.....	202
9.9	SC-FDMA baseband signal generation.....	204
9.10	Timing.....	204
10	Narrowband IoT.....	205
10.0	General.....	205
10.0.1	Frame structure.....	205
10.0.1.1	Frame structure type 1.....	205
10.0.1.2	Frame structure type 2.....	205
10.1	Uplink.....	206
10.1.1	Overview.....	206
10.1.1.1	Physical channels.....	206
10.1.1.2	Physical signals.....	206
10.1.2	Slot structure and physical resources.....	206
10.1.2.1	Resource grid.....	206
10.1.2.2	Resource elements.....	207
10.1.2.3	Resource unit.....	207
10.1.3	Narrowband physical uplink shared channel.....	208
10.1.3.1	Scrambling.....	208
10.1.3.2	Modulation.....	208
10.1.3.3	Layer mapping.....	209
10.1.3.4	Transform precoding.....	209
10.1.3.5	Precoding.....	209
10.1.3.6	Mapping to physical resources.....	209
10.1.4	Demodulation reference signal.....	210
10.1.4.1	Reference signal sequence.....	210
10.1.4.1.1	Reference signal sequence for $N_{sc}^{RU} = 1$	210
10.1.4.1.2	Reference signal sequence for $N_{sc}^{RU} > 1$	211

10.1.4.1.3	Group hopping.....	212
10.1.4.2	Mapping to physical resources.....	213
10.1.5	SC-FDMA baseband signal generation.....	214
10.1.6	Narrowband physical random-access channel.....	215
10.1.6.1	Time and frequency structure.....	215
10.1.6.2	Baseband signal generation.....	218
10.1.7	Modulation and upconversion.....	219
10.2	Downlink.....	219
10.2.1	Overview.....	219
10.2.1.1	Physical channels.....	219
10.2.1.2	Physical signals.....	219
10.2.2	Slot structure and physical resource elements.....	219
10.2.2.1	Resource grid.....	219
10.2.2.2	Resource elements.....	220
10.2.2.3	Guard period for half-duplex FDD operation.....	220
10.2.2.4	Guard period for TDD operation.....	220
10.2.3	Narrowband physical downlink shared channel.....	220
10.2.3.1	Scrambling.....	220
10.2.3.2	Modulation.....	220
10.2.3.3	Layer mapping and precoding.....	220
10.2.3.4	Mapping to resource elements.....	221
10.2.4	Narrowband physical broadcast channel.....	222
10.2.4.1	Scrambling.....	222
10.2.4.2	Modulation.....	222
10.2.4.3	Layer mapping and precoding.....	223
10.2.4.4	Mapping to resource elements.....	223
10.2.5	Narrowband physical downlink control channel.....	223
10.2.5.1	NPDCCH formats.....	223
10.2.5.2	Scrambling.....	224
10.2.5.3	Modulation.....	224
10.2.5.4	Layer mapping and precoding.....	224
10.2.5.5	Mapping to resource elements.....	224
10.2.6	Narrowband reference signal (NRS).....	225
10.2.6.1	Sequence generation.....	228
10.2.6.2	Mapping to resource elements.....	228
10.2.6A	Narrowband positioning reference signal (NPRS).....	230
10.2.6A.1	Sequence generation.....	230
10.2.6A.2	Mapping to resource elements.....	231
10.2.6A.3	NPRS subframe configuration.....	232
10.2.6B	Narrowband wake up signal (NWUS).....	233
10.2.6B.1	Sequence generation.....	233
10.2.6B.2	Mapping to resource elements.....	233
10.2.7	Synchronization signals.....	234
10.2.7.1	Narrowband primary synchronization signal (NPSS).....	234
10.2.7.1.1	Sequence generation.....	234
10.2.7.1.2	Mapping to resource elements.....	234
10.2.7.2	Narrowband secondary synchronization signal (NSSS).....	235
10.2.7.2.1	Sequence generation.....	235
10.2.7.2.2	Mapping to resource elements.....	235
10.2.8	OFDM baseband signal generation.....	236
10.2.9	Modulation and upconversion.....	237
Annex A (informative):	Change history.....	238
History.....		248

Foreword

This Technical Specification has been produced by the 3rd Generation Partnership Project (3GPP).

The contents of the present document are subject to continuing work within the TSG and may change following formal TSG approval. Should the TSG modify the contents of the present document, it will be re-released by the TSG with an identifying change of release date and an increase in version number as follows:

Version x.y.z

where:

- x the first digit:
 - 1 presented to TSG for information;
 - 2 presented to TSG for approval;
 - 3 or greater indicates TSG approved document under change control.
- y the second digit is incremented for all changes of substance, i.e. technical enhancements, corrections, updates, etc.
- z the third digit is incremented when editorial only changes have been incorporated in the document.

1 Scope

The present document describes the physical channels for evolved UTRA.

2 References

The following documents contain provisions which, through reference in this text, constitute provisions of the present document.

- References are either specific (identified by date of publication, edition number, version number, etc.) or non-specific.
- For a specific reference, subsequent revisions do not apply.
- For a non-specific reference, the latest version applies. In the case of a reference to a 3GPP document (including a GSM document), a non-specific reference implicitly refers to the latest version of that document *in the same Release as the present document*.

- [1] 3GPP TR 21.905: "Vocabulary for 3GPP Specifications".
- [2] 3GPP TS 36.201: "Evolved Universal Terrestrial Radio Access (E-UTRA); LTE physical layer; General description".
- [3] 3GPP TS 36.212: "Evolved Universal Terrestrial Radio Access (E-UTRA); Multiplexing and channel coding".
- [4] 3GPP TS 36.213: "Evolved Universal Terrestrial Radio Access (E-UTRA); Physical layer procedures".
- [5] 3GPP TS 36.214: "Evolved Universal Terrestrial Radio Access (E-UTRA); Physical layer; Measurements".
- [6] 3GPP TS 36.104: "Evolved Universal Terrestrial Radio Access (E-UTRA); Base Station (BS) radio transmission and reception".
- [7] 3GPP TS 36.101: "Evolved Universal Terrestrial Radio Access (E-UTRA); User Equipment (UE) radio transmission and reception".
- [8] 3GPP TS 36.321, "Evolved Universal Terrestrial Radio Access (E-UTRA); Medium Access Control (MAC) protocol specification".
- [9] 3GPP TS 36.331, "Evolved Universal Terrestrial Radio Access (E-UTRA); Radio Resource Control (RRC) Protocol specification"
- [10] 3GPP TS 36.304, "Evolved Universal Terrestrial Radio Access (E-UTRA); User Equipment (UE) procedures in idle mode"
- [11] 3GPP TS 37.213: "Physical layer procedures for shared spectrum channel access"
- [12] 3GPP TS 36.300: "Evolved Universal Terrestrial Radio Access (E-UTRA) and Evolved Universal Terrestrial Radio Access Network (E-UTRAN); Overall description; Stage 2"

3 Symbols and abbreviations

3.1 Symbols

For the purposes of the present document, the following symbols apply:

(k, l)	Resource element with frequency-domain index k and time-domain index l
$a_{k,l}^{(p)}$	Value of resource element (k, l) [for antenna port p]
D	Matrix for supporting cyclic delay diversity
D_{RA}	Density of random access opportunities per radio frame
f_0	Carrier frequency
f_{RA}	PRACH resource frequency index within the considered time-domain location
$f_{PRB,hop}^{PRACH}$	PRACH frequency hopping offset, expressed as a number of resource blocks
$l_{NPDCCHstart}$	Start symbol in slot 0 for NPDCCH
$l_{NPDSCHstart}$	Start symbol in slot 0 for NPDSCH
M_{sc}^{PSBCH}	Bandwidth for PSBCH transmission, expressed as a number of subcarriers
M_{RB}^{PSBCH}	Bandwidth for PSBCH transmission, expressed as a number of resource blocks
M_{sc}^{PSCCH}	Bandwidth for PSCCH transmission, expressed as a number of subcarriers
M_{RB}^{PSCCH}	Bandwidth for PSCCH transmission, expressed as a number of resource blocks
M_{sc}^{PSDCH}	Bandwidth for PSDCH transmission, expressed as a number of subcarriers
M_{RB}^{PSDCH}	Bandwidth for PSDCH transmission, expressed as a number of resource blocks
M_{sc}^{PSSCH}	Scheduled bandwidth for PSSCH transmission, expressed as a number of subcarriers
M_{RB}^{PSSCH}	Scheduled bandwidth for PSSCH transmission, expressed as a number of resource blocks
M_{sc}^{PUSCH}	Scheduled bandwidth for uplink transmission, expressed as a number of subcarriers
M_{RB}^{PUSCH}	Scheduled bandwidth for uplink transmission, expressed as a number of resource blocks
M_{rep}^{NPUSCH}	Scheduled number of repetitions of a NPUSCH transmission
M_{rep}^{NPDSCH}	Scheduled number of repetitions of a NPDSCH transmission
M_{sc}^{NPUSCH}	Scheduled bandwidth for uplink NPUSCH transmission, expressed as a number of subcarriers
$M_{identical}^{NPUSCH}$	Number of repetitions of identical slots for NPUSCH
$M_{bit}^{(q)}$	Number of coded bits to transmit on a physical channel [for codeword q]
$M_{symb}^{(q)}$	Number of modulation symbols to transmit on a physical channel [for codeword q]
M_{symb}^{layer}	Number of modulation symbols to transmit per layer for a physical channel
M_{symb}^{ap}	Number of modulation symbols to transmit per antenna port for a physical channel
M_{sc}^{RU}	Number of consecutive subcarriers in an UL resource unit for PUSCH sub-PRB allocation
M_{slots}^{UL}	Number of slots in an UL resource unit for PUSCH sub-PRB allocation
M_{symb}^{UL}	Number of SC-FDMA symbols in an uplink slot for PUSCH sub-PRB allocation
M_{seq}^{RU}	Number of subcarriers in the frequency domain for PUSCH sub-PRB allocation
M_{seq}^{RU}	Number of reference signal sequences available for the UL resource unit size for PUSCH sub-PRB allocation
M_{RU}	Number of scheduled UL resource units for PUSCH sub-PRB allocation
N	A constant equal to 2048 for $\Delta f = 15$ kHz, 4096 for $\Delta f = 7.5$ kHz and 8192 for $\Delta f = 3.75$ kHz
$N_{CP,l}$	Downlink cyclic prefix length for OFDM symbol l in a slot
N_{CS}	Cyclic shift value used for random access preamble generation

$N_{cs}^{(1)}$	Number of cyclic shifts used for PUCCH formats 1/1a/1b in a resource block with a mix of formats 1/1a/1b and 2/2a/2b
$N_{RB}^{(2)}$	Bandwidth available for use by PUCCH formats 2/2a/2b, expressed in multiples of N_{sc}^{RB}
N_{RB}^{HO}	The offset used for PUSCH frequency hopping, expressed in number of resource blocks (set by higher layers)
N_{ID}^{cell}	Physical layer cell identity
N_{ID}^{Ncell}	Narrowband physical layer cell identity
N_{ID}^{MBSFN}	MBSFN area identity
N_{ID}^{SL}	Physical layer sidelink synchronization identity
N_{ID}^{PRS}	Positioning reference signal identity
N_{RB}^{DL}	Downlink bandwidth configuration, expressed in multiples of N_{sc}^{RB}
$N_{RB}^{min,DL}$	Smallest downlink bandwidth configuration, expressed in multiples of N_{sc}^{RB}
$N_{RB}^{max,DL}$	Largest downlink bandwidth configuration, expressed in multiples of N_{sc}^{RB}
N_{RB}^{UL}	Uplink bandwidth configuration, expressed in multiples of N_{sc}^{RB}
$N_{RB}^{min,UL}$	Smallest uplink bandwidth configuration, expressed in multiples of N_{sc}^{RB}
$N_{RB}^{max,UL}$	Largest uplink bandwidth configuration, expressed in multiples of N_{sc}^{RB}
N_{RB}^{SL}	Sidelink bandwidth configuration, expressed in multiples of N_{sc}^{RB}
N_{RSS}	Duration of RSS measured in subframes
N_{SF}	Number of scheduled subframes for NPDSCH transmission
N_{symb}^{NPSS}	Number of symbols for NPSS in a subframe
N_{symb}^{NSSS}	Number of symbols for NSSS in a subframe
N_{sc}^{RU}	Number of consecutive subcarriers in an UL resource unit for NB-IoT
N_{seq}^{RU}	Number of reference signal sequences available for the UL resource unit size
N_{RU}	Number of scheduled UL resource units for NB-IoT
N_{NB}^{UL}	Total number of uplink narrowbands
N_{WB}^{UL}	Total number of uplink widebands
N_{sc}^{UL}	Number of subcarriers in the frequency domain for NB-IoT
N_{acc}	Number of consecutive absolute subframes over which the scrambling sequence stays the same
N_{abs}^{PUSCH}	Total number of absolute subframes a PUSCH with repetition spans expressed as a number of absolute subframes
N_{rep}^{PUSCH}	Number of repetitions of a PUSCH transmission
$N_{NB}^{ch,UL}$	Number of consecutive absolute subframes over which PUCCH or PUSCH stays at the same narrowband before hopping to another narrowband, expressed as a number of absolute subframes
$f_{NB,hop}^{PUSCH}$	Narrowband offset between one narrowband and the next narrowband a PUSCH hops to, expressed as a number of uplink narrowbands
N_{abs}^{PUCCH}	Total number of absolute subframes a PUCCH with repetition spans, expressed as a number of absolute subframes
N_{rep}^{PUCCH}	Number of repetitions of a PUCCH transmission
N_{rep}^{PRACH}	Number of PRACH repetitions per preamble transmission attempt
N_{sf}^{RA}	Number of subframes allowed for preamble transmission within a 1024-frame interval
N_{start}^{PRACH}	PRACH starting subframe periodicity
N_{rep}^{NPRACH}	Number of NPRACH repetitions per preamble transmission attempt
N_{period}^{NPRACH}	NPRACH resource periodicity

$N_{\text{scoffset}}^{\text{NPRACH}}$	Frequency location of the first sub-carrier allocated to NPRACH
$N_{\text{sc}}^{\text{NPRACH}}$	Number of sub-carriers allocated to NPRACH
$N_{\text{sc_cont}}^{\text{NPRACH}}$	Number of starting sub-carriers allocated for UE initiated random access
$N_{\text{start}}^{\text{NPRACH}}$	NPRACH starting subframe
$N_{\text{MSG3}}^{\text{NPRACH}}$	Fraction for starting subcarrier index for UE support for multi-tone msg3 transmission
$N_{\text{gap,period}}$	Periodicity for NPDSCH/NPDCCH gaps
$N_{\text{gap,duration}}$	Duration for NPDSCH/NPDCCH gaps
$N_{\text{gap,threshold}}$	Threshold for applying NPDDCH/NPDCCH gaps
$N_{\text{NB}}^{\text{DL}}$	Total number of downlink narrowbands
$N_{\text{WB}}^{\text{DL}}$	Total number of downlink widebands
$N_{\text{abs}}^{\text{PDSCH}}$	Total number of absolute subframes a PDSCH with repetition spans, expressed as a number of absolute subframes
$N_{\text{rep}}^{\text{PDSCH}}$	Number of repetitions of a PDSCH transmission
$N_{\text{NB}}^{\text{ch,DL}}$	Number of consecutive absolute subframes over which MPDCCH or PDSCH stays at the same narrowband before hopping to another narrowband, expressed as a number of absolute subframes
$N_{\text{NB,hop}}^{\text{ch,DL}}$	Number of narrowbands over which MPDCCH or PDSCH frequency hops
$f_{\text{NB,hop}}^{\text{DL}}$	Narrowband offset between one narrowband and the next narrowband an MPDCCH or PDSCH hops to, expressed as a number of downlink narrowbands
$N_{\text{PDSCH}}^{\text{SIB1-BR}}$	Number of times a PDSCH carrying SIB1-BR is transmitted over 8 radio frames
$N_{\text{abs}}^{\text{MPDCCH}}$	Total number of absolute subframes a MPDCCH with repetition spans, expressed as a number of absolute subframes
$N_{\text{rep}}^{\text{MPDCCH}}$	Number of repetitions of a MPDCCH transmission
$N_{\text{abs,ss}}^{\text{MPDCCH}}$	Total number of absolute subframes a MPDCCH search space with maximum repetition level spans, expressed as a number of absolute subframes
$N_{\text{rep,ss}}^{\text{MPDCCH}}$	Maximum repetition level of a MPDCCH search space
$N_{\text{ECCE}}^{\text{MPDCCH}}$	Number of ECCEs in a subframe for one MPDCCH
$N_{\text{ymb}}^{\text{DL}}$	Number of OFDM symbols in a downlink slot
$N_{\text{ymb}}^{\text{UL}}$	Number of SC-FDMA symbols in an uplink slot
$N_{\text{ymb}}^{\text{retune}}$	Number of symbols in a guard period for narrowband or wideband retuning
$N_{\text{slots}}^{\text{UL}}$	Number of consecutive slots in an UL resource unit for NB-IoT
$N_{\text{ymb}}^{\text{SL}}$	Number of SC-FDMA symbols in a sidelink slot
$N_{\text{sc}}^{\text{RB}}$	Resource block size in the frequency domain, expressed as a number of subcarriers
N_{sb}	Number of sub-bands for PUSCH frequency-hopping with predefined hopping pattern
$N_{\text{RB}}^{\text{sb}}$	Size of each sub-band for PUSCH frequency-hopping with predefined hopping pattern, expressed as a number of resource blocks
$N_{\text{sc}}^{\text{RA}}$	Size of narrow-band random-access resource in number of subcarriers
N_{SP}	Number of downlink to uplink switch points within the radio frame
$N_{\text{RS}}^{\text{PUCCH}}$	Number of reference symbols per slot for PUCCH
$N_{\text{RS}}^{\text{SPUCCH}}$	Number of reference symbols per subslot or per slot for SPUCCH
N_{TA}	Timing offset between uplink and downlink radio frames at the UE, expressed in units of T_s
$N_{\text{TA offset}}$	Fixed timing advance offset, expressed in units of T_s
$N_{\text{TA,SL}}$	Timing offset between sidelink and timing reference frames at the UE, expressed in units of T_s

$n_{\text{PUCCH}}^{(1,\bar{p})}$	Resource index for PUCCH formats 1/1a/1b
$n_{\text{PUCCH}}^{(2,\bar{p})}$	Resource index for PUCCH formats 2/2a/2b
$n_{\text{PUCCH}}^{(3,\bar{p})}$	Resource index for PUCCH format 3
n_{PDCCH}	Number of PDCCHs present in a subframe
n_{PRB}	Physical resource block number
$n_{\text{PRB}}^{\text{RA}}$	First physical resource block occupied by PRACH resource considered
$n_{\text{PRBoffset}}^{\text{RA}}$	First physical resource block available for PRACH
$n_{\text{PRB,RSS}}$	Lowest PRB number of RSS
$n_{\text{sc}}^{\text{RA}}$	Subcarrier occupied by NPRACH resource considered
n_{VRB}	Virtual resource block number
n_{RNTI}	Radio network temporary identifier
$n_{\text{ID}}^{\text{SA}}$	Sidelink group destination identity
n_{f}	System frame number
n_{s}	Slot number within a radio frame
$n_{\text{sf}}^{\text{abs}}$	Absolute subframe number
$n_{\text{sf}}^{\text{RA}}$	Index for subframes allowed for preamble transmission
O_{RSS}	Starting frame offset of RSS in each RSS period
P	Number of antenna ports used for transmission of a channel
p	Antenna port number
P_{RSS}	Period of RSS measured in frames
q	Codeword number
r_{RA}	Index for PRACH versions with same preamble format and PRACH density
Q_m	Modulation order: 1 for $\pi/2$ -BPSK, 2 for QPSK, 4 for 16QAM, 6 for 64QAM and 8 for 256QAM transmissions
$s_l^{(p)}(t)$	Time-continuous baseband signal for antenna port p and OFDM symbol l in a slot
$t_{\text{RA}}^{(0)}$	Radio frame indicator index of PRACH opportunity
$t_{\text{RA}}^{(1)}$	Half frame index of PRACH opportunity within the radio frame
$t_{\text{RA}}^{(2)}$	Uplink subframe number for start of PRACH opportunity within the half frame
T_{f}	Radio frame duration
T_{s}	Basic time unit
T_{slot}	Slot duration
W	Precoding matrix for downlink spatial multiplexing
β_{PRACH}	Amplitude scaling for PRACH
β_{NPRACH}	Amplitude scaling for NPRACH
β_{PUCCH}	Amplitude scaling for PUCCH
β_{PUSCH}	Amplitude scaling for PUSCH
β_{NPUSCH}	Amplitude scaling for NPUSCH
β_{SPUCCH}	Amplitude scaling for SPUCCH
β_{SRS}	Amplitude scaling for sounding reference symbols
Δf	Subcarrier spacing
Δf_{RA}	Subcarrier spacing for the random access preamble
v	Number of transmission layers

3.2 Abbreviations

For the purposes of the present document, the abbreviations given in TR 21.905 [1] and the following apply. An abbreviation defined in the present document takes precedence over the definition of the same abbreviation, if any, in TR 21.905 [1].

CCE	Control Channel Element
CDD	Cyclic Delay Diversity
CRS	Cell-specific Reference Signal
CSI	Channel-State Information
DCI	Downlink Control Information
DM-RS	Demodulation Reference Signal
ECCE	Enhanced Control Channel Element
EPDCCH	Enhanced Physical Downlink Control CHannel
EREG	Enhanced Resource-Element Group
MPDCCH	MTC Physical Downlink Control Channel
MWUS	MTC Wake-Up Signal
NCCE	Narrowband Control Channel Element
NPBCH	Narrowband Physical Broadcast CHannel
NPDCCH	Narrowband Physical Downlink Control CHannel
NPDSCH	Narrowband Physical Downlink Shared CHannel
NPRACH	Narrowband Physical Random Access CHannel
NPUSCH	Narrowband Physical Uplink Shared CHannel
NPRS	Narrowband Positioning Reference Signal
NPSS	Narrowband Primary Synchronization Signal
NSSS	Narrowband Secondary Synchronization Signal
NRS	Narrowband Reference Signal PBCH Physical Broadcast CHannel
PCFICH	Physical Control Format Indicator CHannel
PDCCH	Physical Downlink Control CHannel
PDSCH	Physical Downlink Shared CHannel
PHICH	Physical Hybrid-ARQ Indicator CHannel
PMCH	Physical Multicast CHannel
PRACH	Physical Random Access CHannel
PRB	Physical Resource Block
PRG	Precoding Resource Block Group
PRS	Positioning Reference Signal
PSBCH	Physical Sidelink Broadcast CHannel
PSCCH	Physical Sidelink Control CHannel
PSDCH	Physical Sidelink Discovery CHannel
PSSCH	Physical Sidelink Shared CHannel
PUCCH	Physical Uplink Control CHannel
PUSCH	Physical Uplink Shared CHannel
REG	Resource-Element Group
RSS	Resynchronization Signal
SCCE	Short Control Channel Element
SCG	Secondary Cell Group
SPDCCH	Short Physical Downlink Control CHannel
SPUCCH	Short Physical Uplink Control CHannel
SREG	Short Resource-Element Group
SRS	Sounding Reference Signal
VRB	Virtual Resource Block

4 Frame structure

Throughout this specification, unless otherwise noted, the size of various fields in the time domain is expressed as a number of time units $T_s = 1/(15000 \times 2048)$ seconds.

Downlink, uplink and sidelink transmissions are organized into radio frames with $T_f = 307200 \times T_s = 10$ ms duration. Three radio frame structures are supported:

- Type 1, applicable to FDD only,
- Type 2, applicable to TDD only,
- Type 3, applicable to LAA secondary cell operation only.

NOTE: LAA secondary cell operation only applies to frame structure type 3.

Transmissions in multiple cells can be aggregated where up to 31 secondary cells can be used in addition to the primary cell. Unless otherwise noted, the description in this specification applies to each of the up to 32 serving cells. In case of multi-cell aggregation, different frame structures can be used in the different serving cells.

4.1 Frame structure type 1

Frame structure type 1 is applicable to both full duplex and half duplex FDD only. Each radio frame is $T_f = 307200 \cdot T_s = 10$ ms long and consists of 10 subframes of length $30720 \cdot T_s = 1$ ms, numbered from 0 to 9.

Subframe i in frame n_f has an absolute subframe number $n_{sf}^{abs} = 10n_f + i$ where n_f is the system frame number.

For subframes using $\Delta f = 2.5$ kHz, $\Delta f = 7.5$ kHz, or $\Delta f = 15$ kHz, subframe i is defined as two slots, $2i$ and $2i + 1$, of length $T_{slot} = 15360 \cdot T_s = 0.5$ ms each.

For subframes using $\Delta f = 1.25$ kHz, subframe i is defined as one slot, $2i$, of length $T_{slot} = 30720 \cdot T_s = 1$ ms.

For transmissions using $\Delta f = 1/(82944T_s) \approx 0.37$ kHz, a slot has a length of $92160T_s = 3$ ms. There are 13 slots, numbered in increasing order from 0 to 12, in a 40 ms period starting at $n_f \bmod 4 = 0$ with slot 0 starting at $30720T_s$ in the 40 ms period.

For subframes using $\Delta f = 15$ kHz, the subframe can further be divided into six subslots according to Table 4.1-1.

Downlink subslot pattern 1 is applied if the number of symbols used for PDCCH is equal to 1 or 3 and downlink subslot pattern 2 is applied if the number of symbols used for PDCCH is equal to 2. For system bandwidths $N_{RB}^{DL} \leq 10$, subslot transmission is not supported in case 4 symbols used for PDCCH.

For FDD, 10 subframes, 20 slots, or up to 60 subslots are available for downlink transmission and 10 subframes, 20 slots, or up to 60 subslots are available for uplink transmissions in each 10 ms interval. Uplink and downlink transmissions are separated in the frequency domain. In half-duplex FDD operation, the UE cannot transmit and receive at the same time while there are no such restrictions in full-duplex FDD.

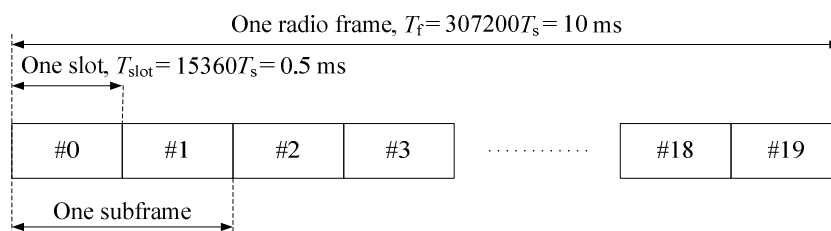

Figure 4.1-1: Frame structure type 1 (assuming $\Delta f \in \{2.5, 7.5, 15\}$ kHz).

Table 4.1-1: SC-FDMA/OFDM symbols in different subslots of subframe i

Subslot number	0	1	2	3	4	5
Slot number	$2i$			$2i+1$		
Uplink subslot pattern	0, 1, 2	3, 4	5, 6	0, 1	2, 3	4, 5, 6
Downlink subslot pattern 1	0, 1, 2	3, 4	5, 6	0, 1	2, 3	4, 5, 6
Downlink subslot pattern 2	0, 1	2, 3, 4	5, 6	0, 1	2, 3	4, 5, 6

4.2 Frame structure type 2

Frame structure type 2 is applicable to TDD only. Each radio frame of length $T_f = 307200 \cdot T_s = 10$ ms consists of two half-frames of length $153600 \cdot T_s = 5$ ms each. Each half-frame consists of five subframes of length $30720 \cdot T_s = 1$ ms. Each subframe i is defined as two slots, $2i$ and $2i + 1$, of length $T_{\text{slot}} = 15360 \cdot T_s = 0.5$ ms each. Subframe i in frame n_f has an absolute subframe number $n_{\text{sf}}^{\text{abs}} = 10n_f + i$ where n_f is the system frame number.

The uplink-downlink configuration in a cell may vary between frames and controls in which subframes uplink or downlink transmissions may take place in the current frame. The uplink-downlink configuration in the current frame is obtained according to Clause 13 in [4].

The supported uplink-downlink configurations are listed in Table 4.2-2 where, for each subframe in a radio frame, "D" denotes a downlink subframe reserved for downlink transmissions, "U" denotes an uplink subframe reserved for uplink transmissions and "S" denotes a special subframe with the three fields DwPTS, GP and UpPTS. The length of DwPTS and UpPTS is given by Table 4.2-1 subject to the total length of DwPTS, GP and UpPTS being equal to $30720 \cdot T_s = 1$ ms where X is the number of additional SC-FDMA symbols in UpPTS provided by the higher layer parameter *srs-UpPtsAdd* if configured otherwise X is equal to 0. The UE is not expected to be configured with 2 additional UpPTS SC-FDMA symbols for special subframe configurations {3, 4, 7, 8} for normal cyclic prefix in downlink and special subframe configurations {2, 3, 5, 6} for extended cyclic prefix in downlink and 4 additional UpPTS SC-FDMA symbols for special subframe configurations {1, 2, 3, 4, 6, 7, 8} for normal cyclic prefix in downlink and special subframe configurations {1, 2, 3, 5, 6} for extended cyclic prefix in downlink.

Uplink-downlink configurations with both 5 ms and 10 ms downlink-to-uplink switch-point periodicity are supported.

- In case of 5 ms downlink-to-uplink switch-point periodicity, the special subframe exists in both half-frames.
- In case of 10 ms downlink-to-uplink switch-point periodicity, the special subframe exists in the first half-frame only.

Subframes 0 and 5 and DwPTS are always reserved for downlink transmission. For special subframe configurations 1, 2, 3, 4, 6, 7 and 8, DwPTS is split into two parts, of which the first part is a slot and the second part is of X -symbol duration within the second slot. Downlink subframes, downlink slots in the downlink subframe and DwPTS, and the X -symbol duration in the second slot of DwPTS are available for downlink transmission. The X -symbol transmission opportunity is only available for special subframe configuration 3,4 and 8.

UpPTS and the subframe immediately following the special subframe are always reserved for uplink transmission. Uplink subframes, uplink slots and UpPTS with special subframe configuration 10 are available for uplink transmission. Note that UpPTS with special subframe configuration 10 are not available for SPUCCH transmission.

In case multiple cells are aggregated, the UE may assume that the guard period of the special subframe in the cells using frame structure type 2 have an overlap of at least $1456 \cdot T_s$.

In case multiple cells with different uplink-downlink configurations in the current radio frame are aggregated and the UE is not capable of simultaneous reception and transmission in the aggregated cells, the following constraints apply:

- if the subframe in the primary cell is a downlink subframe, the UE shall not transmit any signal or channel on a secondary cell in the same subframe
- if the subframe in the primary cell is an uplink subframe, the UE is not expected to receive any downlink transmissions on a secondary cell in the same subframe
- if the subframe in the primary cell is a special subframe and the same subframe in a secondary cell is a downlink subframe, the UE is not expected to receive PDSCH/EPDCCH/PMCH/PRS transmissions in the secondary cell in the same subframe, and the UE is not expected to receive any other signals on the secondary cell in OFDM symbols that overlaps with the guard period or UpPTS in the primary cell.

For frame structure type 2, the higher-layer parameters for symbol-level resource reservation for BL/CE UEs (*symbolBitmap1* and *symbolBitmap2*) do not apply to special subframes.

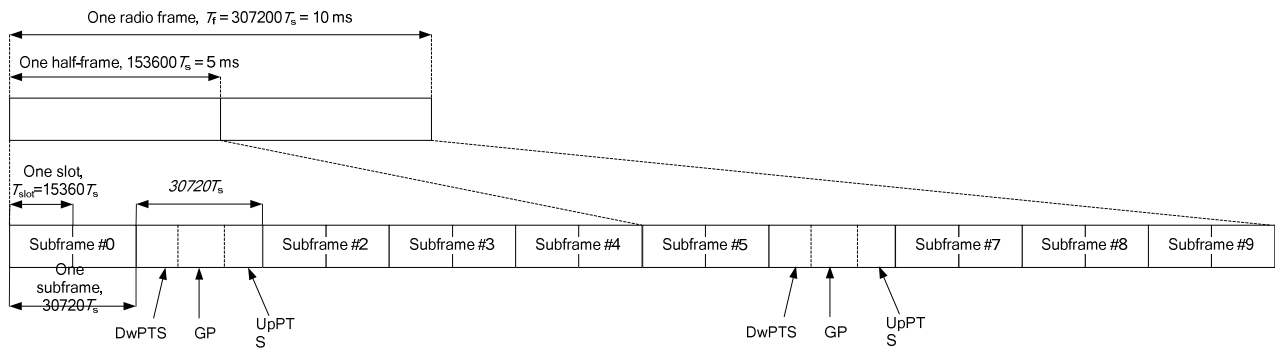

Figure 4.2-1: Frame structure type 2 (for 5 ms switch-point periodicity)

Table 4.2-1: Configuration of special subframe (lengths of DwPTS/GP/UpPTS)

Special subframe configuration n	Normal cyclic prefix in downlink			Extended cyclic prefix in downlink		
	DwPTS	UpPTS		DwPTS	UpPTS	
		Normal cyclic prefix in uplink	Extended cyclic prefix in uplink		Normal cyclic prefix in uplink	Extended cyclic prefix in uplink
0	$6592 \cdot T_s$	$(1+X) \cdot 2192 \cdot T_s$	$(1+X) \cdot 2560 \cdot T_s$	$7680 \cdot T_s$	$(1+X) \cdot 2192 \cdot T_s$	$(1+X) \cdot 2560 \cdot T_s$
1	$19760 \cdot T_s$			$20480 \cdot T_s$		
2	$21952 \cdot T_s$			$23040 \cdot T_s$		
3	$24144 \cdot T_s$			$25600 \cdot T_s$		
4	$26336 \cdot T_s$	$(2+X) \cdot 2192 \cdot T_s$	$(2+X) \cdot 2560 \cdot T_s$	$7680 \cdot T_s$	$(2+X) \cdot 2192 \cdot T_s$	$(2+X) \cdot 2560 \cdot T_s$
5	$6592 \cdot T_s$			$20480 \cdot T_s$		
6	$19760 \cdot T_s$			$23040 \cdot T_s$		
7	$21952 \cdot T_s$			$12800 \cdot T_s$		
8	$24144 \cdot T_s$	-	-	-	-	-
9	$13168 \cdot T_s$	-	-	-	-	-
10	$13168 \cdot T_s$	$13152 \cdot T_s$	$12800 \cdot T_s$	-	-	-

Table 4.2-2: Uplink-downlink configurations

Uplink-downlink configuration	Downlink-to-Uplink Switch-point periodicity	Subframe number										
		0	1	2	3	4	5	6	7	8	9	
0	5 ms	D	S	U	U	U	D	S	U	U	U	
1	5 ms	D	S	U	U	D	D	S	U	U	D	
2	5 ms	D	S	U	D	D	D	S	U	D	D	
3	10 ms	D	S	U	U	U	D	D	D	D	D	
4	10 ms	D	S	U	U	D	D	D	D	D	D	
5	10 ms	D	S	U	D	D	D	D	D	D	D	
6	5 ms	D	S	U	U	U	D	S	U	U	D	

4.3 Frame structure type 3

Frame structure type 3 is applicable to LAA secondary cell operation with normal cyclic prefix only. Each radio frame is $T_f = 307200 \cdot T_s = 10$ ms long and consists of 20 slots of length $T_{slot} = 15360 \cdot T_s = 0.5$ ms, numbered from 0 to 19. A subframe is defined as two consecutive slots where subframe i consists of slots $2i$ and $2i + 1$.

The 10 subframes within a radio frame are available for downlink or uplink transmissions. Downlink transmissions occupy one or more consecutive subframes, starting anywhere within a subframe and ending with the last subframe either fully occupied or following one of the DwPTS durations in Table 4.2-1. Uplink transmissions occupy one or more consecutive subframes.

5 Uplink

5.1 Overview

The smallest resource unit for uplink transmissions is denoted a resource element and is defined in clause 5.2.2.

5.1.1 Physical channels

An uplink physical channel corresponds to a set of resource elements carrying information originating from higher layers and is the interface defined between 3GPP TS 36.212 [3] and the present document 3GPP TS 36.211.

The following uplink physical channels are defined:

- Physical Uplink Shared Channel, PUSCH
- Physical Uplink Control Channel, PUCCH
- Short Physical Uplink Control Channel, SPUCCH
- Physical Random Access Channel, PRACH

5.1.2 Physical signals

An uplink physical signal is used by the physical layer but does not carry information originating from higher layers. The following uplink physical signals are defined:

- Reference signal

5.2 Slot structure and physical resources

5.2.1 Resource grid

The transmitted signal in each slot is described by one or several resource grids of $N_{RB}^{UL} N_{sc}^{RB}$ subcarriers and N_{symb}^{UL} SC-FDMA symbols. The resource grid is illustrated in Figure 5.2.1-1. The quantity N_{RB}^{UL} depends on the uplink transmission bandwidth configured in the cell and shall fulfil

$$N_{RB}^{min,UL} \leq N_{RB}^{UL} \leq N_{RB}^{max,UL}$$

where $N_{RB}^{min,UL} = 6$ and $N_{RB}^{max,UL} = 110$ are the smallest and largest uplink bandwidths, respectively, supported by the current version of this specification. The set of allowed values for N_{RB}^{UL} is given by 3GPP TS 36.101 [7].

The number of SC-FDMA symbols in a slot depends on the cyclic prefix length configured by the higher layer parameter *UL-CyclicPrefixLength* and is given in Table 5.2.3-1.

An antenna port is defined such that the channel over which a symbol on the antenna port is conveyed can be inferred from the channel over which another symbol on the same antenna port is conveyed. There is one resource grid per antenna port. The antenna ports used for transmission of a physical channel or signal depends on the number of antenna ports configured for the physical channel or signal as shown in Table 5.2.1-1. The index \tilde{p} is used throughout clause 5 when a sequential numbering of the antenna ports is necessary.

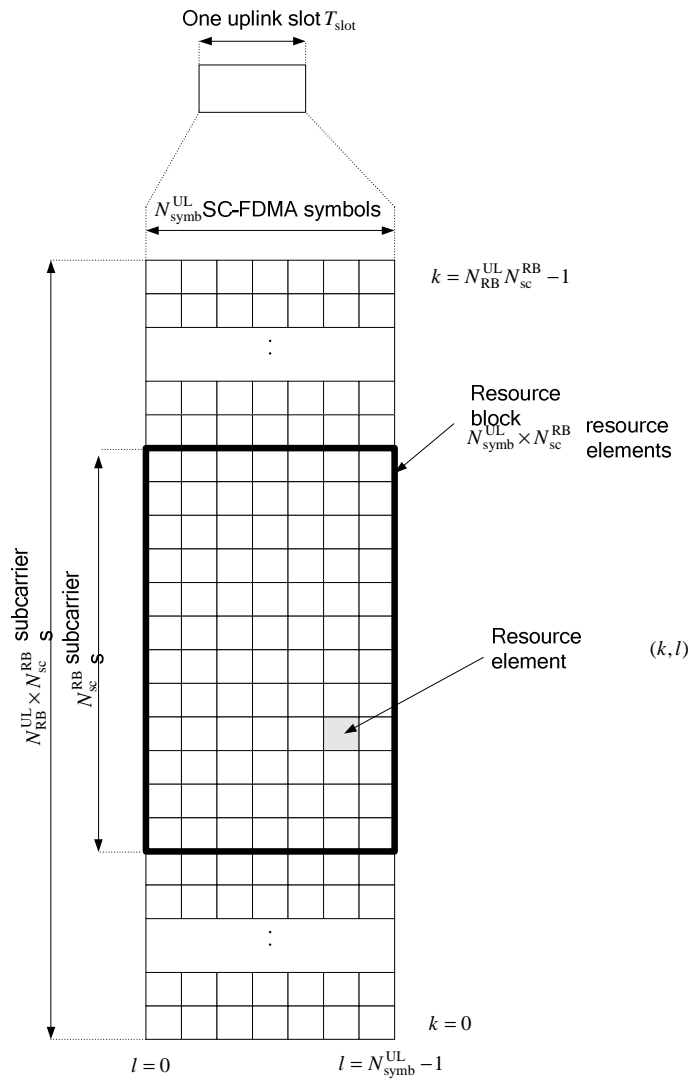

Figure 5.2.1-1: Uplink resource grid

Table 5.2.1-1: Antenna ports used for different physical channels and signals

Physical channel or signal	Index \tilde{p}	Antenna port number p as a function of the number of antenna ports configured for the respective physical channel/signal		
		1	2	4
PUSCH	0	10	20	40
	1	-	21	41
	2	-	-	42
	3	-	-	43
SRS	0	10	20	40
	1	-	21	41
	2	-	-	42
	3	-	-	43
PUCCH, SPUCCH	0	100	200	-
	1	-	201	-

5.2.2 Resource elements

Each element in the resource grid is called a resource element and is uniquely defined by the index pair (k, l) in a slot where $k = 0, \dots, N_{\text{RB}}^{\text{UL}} N_{\text{sc}}^{\text{RB}} - 1$ and $l = 0, \dots, N_{\text{ymb}}^{\text{UL}} - 1$ are the indices in the frequency and time domains, respectively.

Resource element (k, l) on antenna port p corresponds to the complex value $a_{k,l}^{(p)}$.

When there is no risk for confusion, or no particular antenna port is specified, the index p may be dropped.

Quantities $a_{k,l}^{(p)}$ corresponding to resource elements not used for transmission of a physical channel or a physical signal in a slot shall be set to zero.

5.2.3 Resource blocks

A physical resource block is defined as $N_{\text{ymb}}^{\text{UL}}$ consecutive SC-FDMA symbols in the time domain and $N_{\text{sc}}^{\text{RB}}$ consecutive subcarriers in the frequency domain, where $N_{\text{ymb}}^{\text{UL}}$ and $N_{\text{sc}}^{\text{RB}}$ are given by Table 5.2.3-1.

A physical resource block in the uplink thus consists of $N_{\text{ymb}}^{\text{UL}} \times N_{\text{sc}}^{\text{RB}}$ resource elements, corresponding to one slot in the time domain and 180 kHz in the frequency domain.

Table 5.2.3-1: Resource block parameters

Configuration	$N_{\text{sc}}^{\text{RB}}$	$N_{\text{ymb}}^{\text{UL}}$
Normal cyclic prefix	12	7
Extended cyclic prefix	12	6

The relation between the physical resource block number n_{PRB} in the frequency domain and resource elements (k, l) in a slot is given by

$$n_{\text{PRB}} = \left\lfloor \frac{k}{N_{\text{sc}}^{\text{RB}}} \right\rfloor$$

5.2.3A Resource unit

Resource units are used to describe the mapping of PUSCH using sub-PRB allocations to resource elements for BL/CE UEs. A resource unit is defined as $M_{\text{ymb}}^{\text{UL}} M_{\text{slots}}^{\text{UL}}$ SC-FDMA symbols in the time domain and $M_{\text{sc}}^{\text{RU}}$ consecutive subcarriers in the frequency domain, where $M_{\text{sc}}^{\text{RU}}$ and $M_{\text{ymb}}^{\text{UL}}$ are given by Table 5.2.3A-1.

Table 5.2.3A-1: Supported combinations of $M_{\text{sc}}^{\text{RU}}$, $M_{\text{slots}}^{\text{UL}}$, and $M_{\text{ymb}}^{\text{UL}}$ for PUSCH using sub-PRB allocations for Frame Structure type 1 and Frame Structure type 2.

Physical channel	Δf	Modulation scheme	$M_{\text{sc}}^{\text{UL}}$	$M_{\text{sc}}^{\text{RU}}$	$M_{\text{slots}}^{\text{UL}}$	$M_{\text{ymb}}^{\text{UL}}$	Comment
PUSCH	15 kHz	$\pi/2$ -BPSK	12	3	16	7	2 out of 3 subcarriers used
		QPSK		3	8		
				6	4		

5.2.4 Narrowbands and widebands

A narrowband is defined as six non-overlapping consecutive physical resource blocks in the frequency domain. The total number of uplink narrowbands in the uplink transmission bandwidth configured in the cell is given by

$$N_{\text{NB}}^{\text{UL}} = \left\lfloor \frac{N_{\text{RB}}^{\text{UL}}}{6} \right\rfloor$$

The narrowbands are numbered $n_{\text{NB}} = 0, \dots, N_{\text{NB}}^{\text{UL}} - 1$ in order of increasing physical resource-block number where narrowband n_{NB} is composed of physical resource-block indices

$$\begin{cases} 6n_{\text{NB}} + i_0 + i & \text{if } N_{\text{RB}}^{\text{UL}} \bmod 2 = 0 \\ 6n_{\text{NB}} + i_0 + i & \text{if } N_{\text{RB}}^{\text{UL}} \bmod 2 = 1 \text{ and } n_{\text{NB}} < N_{\text{NB}}^{\text{UL}}/2 \\ 6n_{\text{NB}} + i_0 + i + 1 & \text{if } N_{\text{RB}}^{\text{UL}} \bmod 2 = 1 \text{ and } n_{\text{NB}} \geq N_{\text{NB}}^{\text{UL}}/2 \end{cases}$$

where

$$i = 0, 1, \dots, 5$$

$$i_0 = \left\lfloor \frac{N_{\text{RB}}^{\text{UL}}}{2} \right\rfloor - \frac{6N_{\text{NB}}^{\text{UL}}}{2}$$

If $N_{\text{NB}}^{\text{UL}} \geq 4$, a wideband is defined as four non-overlapping narrowbands in the frequency domain. The total number of uplink widebands in the uplink transmission bandwidth configured in the cell is given by

$$N_{\text{WB}}^{\text{UL}} = \left\lfloor \frac{N_{\text{NB}}^{\text{UL}}}{4} \right\rfloor$$

and the widebands are numbered $n_{\text{WB}} = 0, \dots, N_{\text{WB}}^{\text{UL}} - 1$ in order of increasing narrowband number where wideband n_{WB} is composed of narrowband indices $4n_{\text{WB}} + i$ where $i = 0, 1, \dots, 3$.

If $N_{\text{NB}}^{\text{UL}} < 4$, then $N_{\text{WB}}^{\text{UL}} = 1$ and the single wideband is composed of the $N_{\text{NB}}^{\text{UL}}$ non-overlapping narrowband(s).

5.2.5 Guard period for narrowband and wideband retuning

For BL/CE UEs, a guard period of at most $N_{\text{symp}}^{\text{retune}}$ SC-FDMA symbols is created for Tx-to-Tx frequency retuning between two consecutive subframes.

- If the higher layer parameter *ce-RetuningSymbols* is set, then $N_{\text{symp}}^{\text{retune}}$ equals *ce-RetuningSymbols*, otherwise

$$N_{\text{symp}}^{\text{retune}} = 2.$$

- If the higher layer parameter *ce-pusch-maxBandwidth-config* is set to 5 MHz, then the rules for guard period creation defined in the remainder of this clause do not apply for retuning between narrowbands but for retuning between widebands and for transmissions involving multiple widebands.
- If a UE is configured with higher layer parameter *ce-PUSCH-FlexibleStartPRB-AllocConfig* and the allocation resources are not fully within one narrowband, the rules for guard period creation defined in the remainder of this clause apply for retuning between tuning narrowbands, where
 - In case of CEModeA, the tuning narrowband is defined as the 6 consecutive PRBs starting from RB_{start} defined in 8.1.1 of [4] with the center frequency set in the middle.
 - In case of CEModeB, the tuning narrowband is defined as the 6 consecutive PRBs with the center frequency set in the middle of allocated two PRBs.
- If the UE retunes from a first narrowband carrying PUSCH to a second narrowband carrying PUSCH, or if the UE retunes from a first narrowband carrying PUCCH to a second narrowband carrying PUCCH,
 - if $N_{\text{symp}}^{\text{retune}} = 1$, a guard period is created by the UE not transmitting the last SC-FDMA symbol in the first subframe;
 - if $N_{\text{symp}}^{\text{retune}} = 2$, a guard period is created by the UE not transmitting the last SC-FDMA symbol in the first subframe and the first SC-FDMA symbol in the second subframe.

- If the UE retunes from a first narrowband carrying PUCCH to a second narrowband carrying PUSCH,
 - if the PUCCH uses a shortened PUCCH format and $N_{\text{symb}}^{\text{retune}} = 1$, a guard period is created by the UE not transmitting the last SC-FDMA symbol in the first subframe;
 - if the PUCCH uses a shortened PUCCH format and $N_{\text{symb}}^{\text{retune}} = 2$, a guard period is created by the UE not transmitting the last SC-FDMA symbol in the first subframe and the first SC-FDMA symbol in the second subframe;
 - if the PUCCH uses a normal PUCCH format, a guard period is created by the UE not transmitting the first $N_{\text{symb}}^{\text{retune}}$ SC-FDMA symbols in the second subframe.
- If the UE retunes from a first narrowband carrying PUSCH to a second narrowband carrying PUCCH,
 - a guard period is created by the UE not transmitting the last $N_{\text{symb}}^{\text{retune}}$ SC-FDMA symbols in the first subframe.
- For CEModeA, if the PUSCH is associated with C-RNTI or SPS C-RNTI and the higher layer parameter *cepusch-maxBandwidth-config* is set to 5 MHz,
 - If the PUSCH resource allocation is within a 5 MHz wideband, the center frequency of the transmission bandwidth is the center frequency of the wideband;
 - If the PUSCH resource allocation spans two 5 MHz widebands, the center frequency of transmission bandwidth is in the center of PUSCH resource allocation.

Furthermore, for BL/CE UEs configured with the higher layer parameter *srs-UpPtsAdd*, a guard period of at most $N_{\text{symb}}^{\text{retune}}$ SC-FDMA symbols is created for Tx-to-Tx frequency retuning between a first special subframe and a second uplink subframe for frame structure type 2 according to:

- If the UE retunes from a first narrowband carrying SRS in the last UpPTS symbol to a second narrowband carrying PUSCH,
 - a guard period is created by the UE not transmitting the first $N_{\text{symb}}^{\text{retune}}$ SC-FDMA symbols in the second subframe.
- If the UE retunes from a first narrowband carrying SRS in the last but one UpPTS symbol, but not in the last UpPTS symbol, to a second narrowband carrying PUSCH,
 - if $N_{\text{symb}}^{\text{retune}} = 1$, a guard period is created by the UE not transmitting the last UpPTS symbol in the first subframe;
 - if $N_{\text{symb}}^{\text{retune}} = 2$, a guard period is created by the UE not transmitting the last UpPTS symbol in the first subframe and the first SC-FDMA symbol in the second subframe.
- If the UE retunes from a first narrowband carrying SRS to a second narrowband carrying PUCCH,
 - if $N_{\text{symb}}^{\text{retune}} = 1$, a guard period is created by the UE not transmitting the last UpPTS symbol in the first subframe;
 - if $N_{\text{symb}}^{\text{retune}} = 2$, a guard period is created by the UE not transmitting the last UpPTS symbol in the first subframe and the first SC-FDMA symbol in the second subframe.

For $N_{\text{symb}}^{\text{retune}} > 0$, and for SRS transmission in a special subframe, a BL/CE UE is not expected to be configured with a first SRS transmission in symbol l and a second SRS transmission in any of symbols $\{l+1, \dots, l+N_{\text{symb}}^{\text{retune}}\}$ if the first SRS transmission and the second SRS transmission use different narrowbands.

5.3 Physical uplink shared channel

The baseband signal representing the physical uplink shared channel is defined in terms of the following steps:

- scrambling
- modulation of scrambled bits to generate complex-valued symbols
- mapping of the complex-valued modulation symbols onto one or several transmission layers
- transform precoding to generate complex-valued symbols
- precoding of the complex-valued symbols
- mapping of precoded complex-valued symbols to resource elements
- generation of complex-valued time-domain SC-FDMA signal for each antenna port

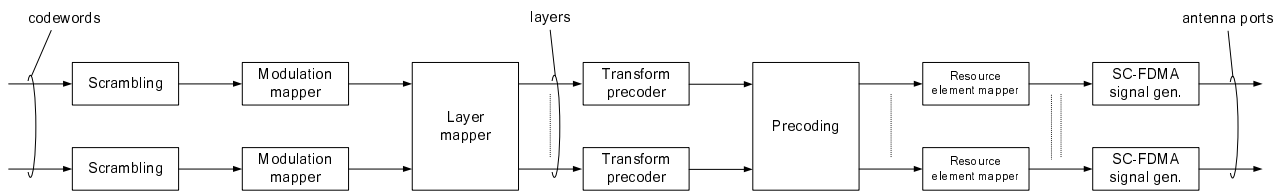

Figure 5.3-1: Overview of uplink physical channel processing

5.3.1 Scrambling

For each codeword q , the block of bits $b^{(q)}(0), \dots, b^{(q)}(M_{\text{bit}}^{(q)} - 1)$, where $M_{\text{bit}}^{(q)}$ is the number of bits transmitted in codeword q on the physical uplink shared channel in subframe(s)/slot/subslot, shall be scrambled with a UE-specific scrambling sequence prior to modulation, resulting in a block of scrambled bits $\tilde{b}^{(q)}(0), \dots, \tilde{b}^{(q)}(M_{\text{bit}}^{(q)} - 1)$ according to the following pseudo code

Set $i = 0$

while $i < M_{\text{bit}}^{(q)}$

if $b^{(q)}(i) = x$ // ACK/NACK or Rank Indication placeholder bits

$$\tilde{b}^{(q)}(i) = 1$$

else

if $b^{(q)}(i) = y$ // ACK/NACK or Rank Indication repetition placeholder bits

$$\tilde{b}^{(q)}(i) = \tilde{b}^{(q)}(i-1)$$

else // Data or channel quality coded bits, Rank Indication coded bits or ACK/NACK coded bits

$$\tilde{b}^{(q)}(i) = (b^{(q)}(i) + c^{(q)}(i)) \bmod 2$$

end if

end if

$i = i + 1$

end while

where x and y are tags defined in 3GPP TS 36.212 [3] clause 5.2.2.6 and where the scrambling sequence $c^{(q)}(i)$ is given by clause 7.2. The scrambling sequence generator shall be initialised with

$c_{\text{init}} = n_{\text{RNTI}} \cdot 2^{14} + q \cdot 2^{13} + \lfloor n_s/2 \rfloor \cdot 2^9 + N_{\text{ID}}^{\text{cell}}$ at the start of each subframe where n_{RNTI} corresponds to the RNTI associated with the PUSCH transmission as described in clause 8 in 3GPP TS 36.213 [4]. For AUL PUSCH, $n_{\text{RNTI}} = 0$.

For BL/CE UEs,

- if the PUSCH transmission is using sub-PRB allocations, the scrambling sequence generator shall be initialised with

$$c_{\text{init}} = n_{\text{RNTI}} \cdot 2^{14} + q \cdot 2^{13} + \left[\left\lfloor \frac{i}{M_{\text{RU}} \cdot M_{\text{slots}}^{\text{UL}} / 2} \right\rfloor \bmod 10 \right] \cdot 2^9 + N_{\text{ID}}^{\text{cell}}$$

at the first valid uplink subframe of every $M_{\text{RU}} \cdot M_{\text{slots}}^{\text{UL}} / 2$ subframes comprising the allocated UL resource unit(s), where $i = 0, 1, \dots, N - 1$, and N is the number of BL/CE UL subframes for the PUSCH transmission as determined in subclause 8.0 in [4].

- otherwise, the same scrambling sequence is applied per subframe to PUSCH for a given block of N_{acc} subframes. The subframe number of the first subframe in each block of N_{acc} consecutive subframes, denoted as $n_{\text{abs},1}$, satisfies $n_{\text{abs},1} \bmod N_{\text{acc}} = 0$. For the j^{th} block of N_{acc} subframes, the scrambling sequence generator shall be initialised with

$$c_{\text{init}} = n_{\text{RNTI}} \cdot 2^{14} + q \cdot 2^{13} + [(j_0 + j)N_{\text{acc}} \bmod 10] \cdot 2^9 + N_{\text{ID}}^{\text{cell}}$$

where

$$j = 0, 1, \dots, \left\lfloor \frac{i_0 + N_{\text{abs}}^{\text{PUSCH}} - 1}{N_{\text{acc}}} \right\rfloor - j_0$$

$$j_0 = \lfloor i_0 / N_{\text{acc}} \rfloor$$

and i_0 is the absolute subframe number of the first uplink subframe intended for PUSCH. The PUSCH transmission spans $N_{\text{abs}}^{\text{PUSCH}}$ consecutive subframes including subframes that are not BL/CE UL subframes where the UE postpones the PUSCH transmission. For a BL/CE UE configured in CEModeA, $N_{\text{acc}} = 1$. For a BL/CE UE configured with CEModeB, $N_{\text{acc}} = 4$ for frame structure type 1 and $N_{\text{acc}} = 5$ for frame structure type 2.

For PUSCH with a subframe duration, up to two codewords can be transmitted in one subframe, i.e., $q \in \{0,1\}$. In the case of single-codeword transmission, $q = 0$.

5.3.2 Modulation

For each codeword q , the block of scrambled bits $\tilde{b}^{(q)}(0), \dots, \tilde{b}^{(q)}(M_{\text{bit}}^{(q)} - 1)$ shall be modulated as described in clause 7.1, resulting in a block of complex-valued symbols $d^{(q)}(0), \dots, d^{(q)}(M_{\text{symb}}^{(q)} - 1)$. Table 5.3.2-1 specifies the modulation mappings applicable for the physical uplink shared channel. For sub-PRB allocations only $\pi/2$ BPSK and QPSK are supported.

Table 5.3.2-1: Uplink modulation schemes

Physical channel	Modulation schemes
PUSCH	$\pi/2$ BPSK, QPSK, 16QAM, 64QAM, 256QAM

5.3.2A Layer mapping

The complex-valued modulation symbols for each of the codewords to be transmitted are mapped onto one or two layers. Complex-valued modulation symbols $d^{(q)}(0), \dots, d^{(q)}(M_{\text{symb}}^{(q)} - 1)$ for codeword q shall be mapped onto the layers $x(i) = [x^{(0)}(i) \ \dots \ x^{(v-1)}(i)]^T$, $i = 0, 1, \dots, M_{\text{symb}}^{\text{layer}} - 1$ where v is the number of layers and $M_{\text{symb}}^{\text{layer}}$ is the number of modulation symbols per layer.

5.3.2A.1 Layer mapping for transmission on a single antenna port

For transmission on a single antenna port, a single layer is used, $v = 1$, and the mapping is defined by

$$x^{(0)}(i) = d^{(0)}(i)$$

with $M_{\text{symb}}^{\text{layer}} = M_{\text{symb}}^{(0)}$.

5.3.2A.2 Layer mapping for spatial multiplexing

For spatial multiplexing, the layer mapping shall be done according to Table 5.3.2A.2-1. The number of layers v is less than or equal to the number of antenna ports P used for transmission of the physical uplink shared channel. The case of a single codeword mapped to multiple layers is only applicable when the number of antenna ports used for PUSCH is four, except for slot-PUSCH and subslot-PUSCH transmission where a single codeword is used irrespective of the number of layers.

Table 5.3.2A.2-1: Codeword-to-layer mapping for spatial multiplexing

Number of layers	Number of codewords	Codeword-to-layer mapping $i = 0, 1, \dots, M_{\text{symb}}^{\text{layer}} - 1$
1	1	$x^{(0)}(i) = d^{(0)}(i)$ $M_{\text{symb}}^{\text{layer}} = M_{\text{symb}}^{(0)}$
2	1	$x^{(0)}(i) = d^{(0)}(2i)$ $x^{(1)}(i) = d^{(0)}(2i+1)$ $M_{\text{symb}}^{\text{layer}} = M_{\text{symb}}^{(0)} / 2$
2	2	$x^{(0)}(i) = d^{(0)}(i)$ $x^{(1)}(i) = d^{(1)}(i)$ $M_{\text{symb}}^{\text{layer}} = M_{\text{symb}}^{(0)} = M_{\text{symb}}^{(1)}$
3	2	$x^{(0)}(i) = d^{(0)}(i)$ $x^{(1)}(i) = d^{(1)}(2i)$ $x^{(2)}(i) = d^{(1)}(2i+1)$ $M_{\text{symb}}^{\text{layer}} = M_{\text{symb}}^{(0)} = M_{\text{symb}}^{(1)} / 2$
4	2	$x^{(0)}(i) = d^{(0)}(2i)$ $x^{(1)}(i) = d^{(0)}(2i+1)$ $x^{(2)}(i) = d^{(1)}(2i)$ $x^{(3)}(i) = d^{(1)}(2i+1)$ $M_{\text{symb}}^{\text{layer}} = M_{\text{symb}}^{(0)} / 2 = M_{\text{symb}}^{(1)} / 2$
4 ¹	1 ¹	$x^{(0)}(i) = d^{(0)}(4i)$ $x^{(1)}(i) = d^{(0)}(4i+1)$ $x^{(2)}(i) = d^{(0)}(4i+2)$ $x^{(3)}(i) = d^{(0)}(4i+3)$ $M_{\text{symb}}^{\text{layer}} = M_{\text{symb}}^{(0)} / 4$

NOTE 1: Only used for slot-PUSCH and subslot-PUSCH

5.3.3 Transform precoding

For each layer $\lambda = 0, 1, \dots, v-1$ the block of complex-valued symbols $x^{(\lambda)}(0), \dots, x^{(\lambda)}(M_{\text{symb}}^{\text{layer}} - 1)$ is divided into $M_{\text{symb}}^{\text{layer}} / M_{\text{sc}}^{\text{PUSCH}}$ sets, each corresponding to one SC-FDMA symbol. Transform precoding shall be applied according to

$$y^{(\lambda)}(l \cdot M_{\text{sc}}^{\text{PUSCH}} + k) = \frac{1}{\sqrt{M_{\text{sc}}^{\text{PUSCH}}}} \sum_{i=0}^{M_{\text{sc}}^{\text{PUSCH}} - 1} x^{(\lambda)}(l \cdot M_{\text{sc}}^{\text{PUSCH}} + i) e^{-j \frac{2\pi i k}{M_{\text{sc}}^{\text{PUSCH}}}}$$

$$k = 0, \dots, M_{\text{sc}}^{\text{PUSCH}} - 1$$

$$l = 0, \dots, M_{\text{symb}}^{\text{layer}} / M_{\text{sc}}^{\text{PUSCH}} - 1$$

resulting in a block of complex-valued symbols $y^{(\lambda)}(0), \dots, y^{(\lambda)}(M_{\text{symb}}^{\text{layer}} - 1)$. The variable $M_{\text{sc}}^{\text{PUSCH}} = M_{\text{RB}}^{\text{PUSCH}} \cdot N_{\text{sc}}^{\text{RB}}$, where $M_{\text{RB}}^{\text{PUSCH}}$ represents the bandwidth of the PUSCH in terms of resource blocks, and shall fulfil

$$M_{\text{RB}}^{\text{PUSCH}} = 2^{\alpha_2} \cdot 3^{\alpha_3} \cdot 5^{\alpha_5} \leq N_{\text{RB}}^{\text{UL}}$$

where $\alpha_2, \alpha_3, \alpha_5$ is a set of non-negative integers.

In case of PUSCH transmissions using sub-PRB allocations for BL/CE UEs, the variable $M_{\text{sc}}^{\text{PUSCH}} = M_{\text{sc}}^{\text{RU}} + Q_m - 2$.

5.3.3A Precoding

The precoder takes as input a block of vectors $[y^{(0)}(i) \ \dots \ y^{(v-1)}(i)]^T$, $i = 0, 1, \dots, M_{\text{symb}}^{\text{layer}} - 1$ from the transform precoder and generates a block of vectors $[z^{(0)}(i) \ \dots \ z^{(P-1)}(i)]^T$, $i = 0, 1, \dots, M_{\text{symb}}^{\text{ap}} - 1$ to be mapped onto resource elements.

5.3.3A.1 Precoding for transmission on a single antenna port

For transmission on a single antenna port, precoding is defined by

$$z^{(0)}(i) = y^{(0)}(i)$$

where $i = 0, 1, \dots, M_{\text{symb}}^{\text{ap}} - 1$, $M_{\text{symb}}^{\text{ap}} = M_{\text{symb}}^{\text{layer}}$.

5.3.3A.2 Precoding for spatial multiplexing

Precoding for spatial multiplexing is only used in combination with layer mapping for spatial multiplexing as described in clause 5.3.2A.2. Spatial multiplexing supports $P = 2$ or $P = 4$ antenna ports where the set of antenna ports used for spatial multiplexing is $p \in \{20, 21\}$ and $p \in \{40, 41, 42, 43\}$, respectively.

Precoding for spatial multiplexing is defined by

$$\begin{bmatrix} z^{(0)}(i) \\ \vdots \\ z^{(P-1)}(i) \end{bmatrix} = W \begin{bmatrix} y^{(0)}(i) \\ \vdots \\ y^{(v-1)}(i) \end{bmatrix}$$

where $i = 0, 1, \dots, M_{\text{symb}}^{\text{ap}} - 1$, $M_{\text{symb}}^{\text{ap}} = M_{\text{symb}}^{\text{layer}}$.

The precoding matrix W of size $P \times v$ is given by one of the entries in Table 5.3.3A.2-1 for $P = 2$ and by Tables 5.3.3A.2-2 through 5.3.3A.2-5 for $P = 4$ where the entries in each row are ordered from left to right in increasing order of codebook indices.

Table 5.3.3A.2-1: Codebook for transmission on antenna ports {20,21}

Codebook index	Number of layers	
	$v = 1$	$v = 2$
0	$\frac{1}{\sqrt{2}} \begin{bmatrix} 1 \\ 1 \end{bmatrix}$	$\frac{1}{\sqrt{2}} \begin{bmatrix} 1 & 0 \\ 0 & 1 \end{bmatrix}$
1	$\frac{1}{\sqrt{2}} \begin{bmatrix} 1 \\ -1 \end{bmatrix}$	-
2	$\frac{1}{\sqrt{2}} \begin{bmatrix} 1 \\ j \end{bmatrix}$	-
3	$\frac{1}{\sqrt{2}} \begin{bmatrix} 1 \\ -j \end{bmatrix}$	-
4	$\frac{1}{\sqrt{2}} \begin{bmatrix} 1 \\ 0 \end{bmatrix}$	-
5	$\frac{1}{\sqrt{2}} \begin{bmatrix} 0 \\ 1 \end{bmatrix}$	-

Table 5.3.3A.2-2: Codebook for transmission on antenna ports {40,41,42,43} with $v = 1$

Codebook index	Number of layers $v = 1$							
	0 – 7	$\frac{1}{2} \begin{bmatrix} 1 \\ 1 \\ 1 \\ -1 \end{bmatrix}$	$\frac{1}{2} \begin{bmatrix} 1 \\ 1 \\ j \\ j \end{bmatrix}$	$\frac{1}{2} \begin{bmatrix} 1 \\ 1 \\ -1 \\ 1 \end{bmatrix}$	$\frac{1}{2} \begin{bmatrix} 1 \\ 1 \\ -j \\ -j \end{bmatrix}$	$\frac{1}{2} \begin{bmatrix} 1 \\ j \\ 1 \\ j \end{bmatrix}$	$\frac{1}{2} \begin{bmatrix} 1 \\ j \\ j \\ 1 \end{bmatrix}$	$\frac{1}{2} \begin{bmatrix} 1 \\ j \\ -1 \\ -j \end{bmatrix}$
8 – 15	$\frac{1}{2} \begin{bmatrix} 1 \\ -1 \\ 1 \\ 1 \end{bmatrix}$	$\frac{1}{2} \begin{bmatrix} 1 \\ -1 \\ j \\ -j \end{bmatrix}$	$\frac{1}{2} \begin{bmatrix} 1 \\ -1 \\ -1 \\ -1 \end{bmatrix}$	$\frac{1}{2} \begin{bmatrix} 1 \\ -1 \\ -j \\ j \end{bmatrix}$	$\frac{1}{2} \begin{bmatrix} 1 \\ -j \\ 1 \\ -j \end{bmatrix}$	$\frac{1}{2} \begin{bmatrix} 1 \\ -j \\ j \\ -1 \end{bmatrix}$	$\frac{1}{2} \begin{bmatrix} 1 \\ -j \\ -1 \\ j \end{bmatrix}$	$\frac{1}{2} \begin{bmatrix} 1 \\ -j \\ -j \\ 1 \end{bmatrix}$
16 – 23	$\frac{1}{2} \begin{bmatrix} 1 \\ 0 \\ 1 \\ 0 \end{bmatrix}$	$\frac{1}{2} \begin{bmatrix} 1 \\ 0 \\ -1 \\ 0 \end{bmatrix}$	$\frac{1}{2} \begin{bmatrix} 1 \\ 0 \\ j \\ 0 \end{bmatrix}$	$\frac{1}{2} \begin{bmatrix} 1 \\ 0 \\ -j \\ 0 \end{bmatrix}$	$\frac{1}{2} \begin{bmatrix} 0 \\ 1 \\ 0 \\ 1 \end{bmatrix}$	$\frac{1}{2} \begin{bmatrix} 0 \\ 1 \\ 0 \\ -1 \end{bmatrix}$	$\frac{1}{2} \begin{bmatrix} 0 \\ 1 \\ 0 \\ j \end{bmatrix}$	$\frac{1}{2} \begin{bmatrix} 0 \\ 1 \\ 0 \\ -j \end{bmatrix}$

Table 5.3.3A.2-3: Codebook for transmission on antenna ports {40,41,42,43} with $v = 2$

Codebook index	Number of layers $v = 2$			
0-3	$\frac{1}{2} \begin{bmatrix} 1 & 0 \\ 1 & 0 \\ 0 & 1 \\ 0 & -j \end{bmatrix}$	$\frac{1}{2} \begin{bmatrix} 1 & 0 \\ 1 & 0 \\ 0 & 1 \\ 0 & j \end{bmatrix}$	$\frac{1}{2} \begin{bmatrix} 1 & 0 \\ -j & 0 \\ 0 & 1 \\ 0 & 1 \end{bmatrix}$	$\frac{1}{2} \begin{bmatrix} 1 & 0 \\ -j & 0 \\ 0 & 1 \\ 0 & -1 \end{bmatrix}$
4-7	$\frac{1}{2} \begin{bmatrix} 1 & 0 \\ -1 & 0 \\ 0 & 1 \\ 0 & -j \end{bmatrix}$	$\frac{1}{2} \begin{bmatrix} 1 & 0 \\ -1 & 0 \\ 0 & 1 \\ 0 & j \end{bmatrix}$	$\frac{1}{2} \begin{bmatrix} 1 & 0 \\ j & 0 \\ 0 & 1 \\ 0 & 1 \end{bmatrix}$	$\frac{1}{2} \begin{bmatrix} 1 & 0 \\ j & 0 \\ 0 & 1 \\ 0 & -1 \end{bmatrix}$
8-11	$\frac{1}{2} \begin{bmatrix} 1 & 0 \\ 0 & 1 \\ 1 & 0 \\ 0 & 1 \end{bmatrix}$	$\frac{1}{2} \begin{bmatrix} 1 & 0 \\ 0 & 1 \\ 1 & 0 \\ 0 & -1 \end{bmatrix}$	$\frac{1}{2} \begin{bmatrix} 1 & 0 \\ 0 & 1 \\ -1 & 0 \\ 0 & 1 \end{bmatrix}$	$\frac{1}{2} \begin{bmatrix} 1 & 0 \\ 0 & 1 \\ -1 & 0 \\ 0 & -1 \end{bmatrix}$
12-15	$\frac{1}{2} \begin{bmatrix} 1 & 0 \\ 0 & 1 \\ 0 & 1 \\ 1 & 0 \end{bmatrix}$	$\frac{1}{2} \begin{bmatrix} 1 & 0 \\ 0 & 1 \\ 0 & -1 \\ 1 & 0 \end{bmatrix}$	$\frac{1}{2} \begin{bmatrix} 1 & 0 \\ 0 & 1 \\ 0 & 1 \\ -1 & 0 \end{bmatrix}$	$\frac{1}{2} \begin{bmatrix} 1 & 0 \\ 0 & 1 \\ 0 & -1 \\ -1 & 0 \end{bmatrix}$

Table 5.3.3A.2-4: Codebook for transmission on antenna ports {40,41,42,43} with $v = 3$

Codebook index	Number of layers $v = 3$			
0-3	$\frac{1}{2} \begin{bmatrix} 1 & 0 & 0 \\ 1 & 0 & 0 \\ 0 & 1 & 0 \\ 0 & 0 & 1 \end{bmatrix}$	$\frac{1}{2} \begin{bmatrix} 1 & 0 & 0 \\ -1 & 0 & 0 \\ 0 & 1 & 0 \\ 0 & 0 & 1 \end{bmatrix}$	$\frac{1}{2} \begin{bmatrix} 1 & 0 & 0 \\ 0 & 1 & 0 \\ 1 & 0 & 0 \\ 0 & 0 & 1 \end{bmatrix}$	$\frac{1}{2} \begin{bmatrix} 1 & 0 & 0 \\ 0 & 1 & 0 \\ -1 & 0 & 0 \\ 0 & 0 & 1 \end{bmatrix}$
4-7	$\frac{1}{2} \begin{bmatrix} 1 & 0 & 0 \\ 0 & 1 & 0 \\ 0 & 0 & 1 \\ 1 & 0 & 0 \end{bmatrix}$	$\frac{1}{2} \begin{bmatrix} 1 & 0 & 0 \\ 0 & 1 & 0 \\ 0 & 0 & 1 \\ -1 & 0 & 0 \end{bmatrix}$	$\frac{1}{2} \begin{bmatrix} 0 & 1 & 0 \\ 1 & 0 & 0 \\ 1 & 0 & 0 \\ 0 & 0 & 1 \end{bmatrix}$	$\frac{1}{2} \begin{bmatrix} 0 & 1 & 0 \\ 1 & 0 & 0 \\ -1 & 0 & 0 \\ 0 & 0 & 1 \end{bmatrix}$
8-11	$\frac{1}{2} \begin{bmatrix} 0 & 1 & 0 \\ 1 & 0 & 0 \\ 0 & 0 & 1 \\ 1 & 0 & 0 \end{bmatrix}$	$\frac{1}{2} \begin{bmatrix} 0 & 1 & 0 \\ 1 & 0 & 0 \\ 0 & 0 & 1 \\ -1 & 0 & 0 \end{bmatrix}$	$\frac{1}{2} \begin{bmatrix} 0 & 1 & 0 \\ 0 & 0 & 1 \\ 1 & 0 & 0 \\ 1 & 0 & 0 \end{bmatrix}$	$\frac{1}{2} \begin{bmatrix} 0 & 1 & 0 \\ 0 & 0 & 1 \\ 1 & 0 & 0 \\ -1 & 0 & 0 \end{bmatrix}$

Table 5.3.3A.2-5: Codebook for transmission on antenna ports {40,41,42,43} with $v = 4$

Codebook index	Number of layers $v = 4$
0	$\frac{1}{2} \begin{bmatrix} 1 & 0 & 0 & 0 \\ 0 & 1 & 0 & 0 \\ 0 & 0 & 1 & 0 \\ 0 & 0 & 0 & 1 \end{bmatrix}$

5.3.4 Mapping to physical resources

For each antenna port p used for transmission of the PUSCH in a subframe the block of complex-valued symbols $z^{(\tilde{p})}(0), \dots, z^{(\tilde{p})}(M_{\text{symb}}^{\text{ap}} - 1)$ shall be multiplied with the amplitude scaling factor β_{PUSCH} in order to conform to the transmit power P_{PUSCH} specified in clause 5.1.1.1 in 3GPP TS 36.213 [4], and mapped in sequence starting with $z^{(\tilde{p})}(0)$ to physical resource blocks on antenna port p and assigned for transmission of PUSCH. The relation between the index \tilde{p} and the antenna port number p is given by Table 5.2.1-1. The mapping to resource elements (k, l) corresponding to the physical resource blocks assigned for transmission shall fulfil the following criteria:

- not used for transmission of reference signals, and
- not part of the last SC-FDMA symbol in a subframe, if the UE transmits SRS in the same subframe in the same serving cell, and
- not part of the last SC-FDMA symbol in a subframe configured with cell-specific SRS for non-BL/CE UEs and BL/CE UEs in CEModeA, if the PUSCH transmission partly or fully overlaps with the cell-specific SRS bandwidth, and
- not part of an SC-FDMA symbol reserved for possible trigger type 1 SRS transmission as specified in [4] in a UE-specific aperiodic SRS subframe in the same serving cell, and
- not part of an SC-FDMA symbol reserved for possible trigger type 0 SRS transmission as specified in [4] in a UE-specific periodic SRS subframe in the same serving cell when the UE is configured with multiple TAGs
- not part of the first SC-FDMA symbol in a subframe if the associated DCI indicates PUSCH starting position '01', '10', or '11' and does not indicate PUSCH mode 2.
- not part of the first SC-FDMA symbol in the second slot in a subframe if the associated DCI indicates PUSCH starting position '01', '10', or '11' and PUSCH mode 2.
- not part of the last SC-FDMA symbol in a subframe if the associated DCI indicates PUSCH ending symbol '1' and does not indicate PUSCH mode 3.
- not part of the second slot in a subframe if the associated DCI indicates PUSCH ending symbol '0' and PUSCH mode 3.
- not part of SC-FDMA symbols 5 to 13 in a subframe if the associated DCI indicates PUSCH ending symbol '1' and PUSCH mode 3.

The mapping to resource elements (k, l) shall be in increasing order of first the index k , then the index l . The mapping starts with the first slot in an uplink subframe, except for slot-PUSCH, subslot-PUSCH transmission, or PUSCH mode 2.

In case of PUSCH transmissions using sub-PRB allocations for BL/CE UEs, the mapping starts over in every valid uplink subframe composing an UL resource unit.

In case of slot-PUSCH, the mapping shall start at $l = 0$ in the slot assigned for transmission.

In case of PUSCH mode 2, the mapping shall start at $l = 0$ in the second slot of the subframe assigned for transmission.

In case of subslot-PUSCH, the mapping shall start at symbol l where the start of the mapping is dependent on the uplink subslot number in the subframe assigned for transmission and the *DMRS-pattern* field in the related uplink DCI format [3] according to Table 5.3.4-1 where starting symbol index "4" for subslot #5 is applied if the UE has indicated the capability *ul-pattern-ddd-r15*.

Table 5.3.4-1: Starting symbol index for subslot-PUSCH transmission

<i>DMRS-pattern</i> field in uplink-related DCI format [3]	Uplink subslot number					
	#0	#1	#2	#3	#4	#5
00	1	4	6	1	3	5
01	0	3	5	0	2	4
10	–	3	–	0	2	–
11	–	3	–	–	2	–

In case of a semi-persistently scheduled subslot-PUSCH, and semi-persistent scheduling (i.e. higher layer parameter *sps-ConfigUL-STTI* is configured, see 3GPP TS 36.331 [9]) with a configured periodicity of 1 subslot (i.e. *semiPersistSchedIntervalUL-STTI* set to *sTTI*), the mapping shall start at symbol l depending on the *DMRS-pattern* field in the related uplink DCI format [3] according to Table 5.3.4-2.

In case of a semi-persistently scheduled subslot-PUSCH and semi-persistent scheduling (the higher layer parameter *sps-ConfigUL-STTI-r15* is configured, see 3GPP TS 36.331 [9]) with repetitions enabled (the higher layer parameter *totalNumberPUSCH-SPS-STTI-UL-Repetitions* is configured), the mapping shall start at symbol l depending on the *DMRS-pattern* field in the related uplink DCI format [3] according to Table 5.3.4-2.

Table 5.3.4-2: Starting symbol index for subslot-PUSCH transmission in case of semi-persistent scheduling with a configured periodicity of 1 subslot

<i>DMRS-pattern</i> field in uplink-related DCI format [3]	Uplink subslot number					
	#0	#1	#2	#3	#4	#5
00	1	4	6	1	3	5
10	1	3	6	0	3	5

In case of subslot-PUSCH and semi-persistent scheduling with a configured periodicity longer than 1 subslot the mapping shall start at symbol l according to the first row of Table 5.3.4-2 (i.e. equivalent to a signalling of *DMRS-pattern* field set to '00').

For the UpPTS, the mapping shall start at symbol $l = 1$ and if *dmrsLess-UpPts* is set to true the mapping shall end at symbol $l = symPUSCH_UpPts$ in the second slot of a special subframe, otherwise, the mapping shall end at symbol $l = symPUSCH_UpPts + 1$ in the second slot of a special subframe.

For BL/CE UEs, the PUSCH transmission is restricted as follows:

- For CEModeA, if the PUSCH is associated with C-RNTI or SPS C-RNTI and the higher layer parameter *ce-pusch-maxBandwidth-config* is set to 5 MHz, the maximum number of allocatable PRBs for PUSCH is 24 PRBs. The allocatable PRBs include the PRBs belonging to the narrowbands defined in clause 5.2.4 and the odd PRB at the center of the uplink system bandwidth in case of odd total number of uplink PRBs. If a resource assignment or frequency hopping would result in a PUSCH resource allocation outside the allocatable PRBs then the PUSCH transmission in that subframe is dropped.
- For all other cases, the maximum number of allocatable PRBs for PUSCH is 6 PRBs restricted to one of the narrowbands defined in clause 5.2.4.

For BL/CE UEs in CEModeB, resource elements in the last SC-FDMA symbol in a subframe configured with cell-specific SRS shall be counted in the PUSCH mapping but not used for transmission of the PUSCH.

For BL/CE UEs, if one or more SC-FDMA symbol(s) are left empty due to guard period for narrowband or wideband retuning, the affected SC-FDMA symbol(s) shall be counted in the PUSCH mapping but not used for transmission of the PUSCH.

For a UE configured with SRS carrier switching, if the first symbol in a subframe overlaps with an SRS transmission (including any interruption due to uplink or downlink RF retuning time) in a carrier without PUSCH/PUCCH, the resource elements in the first SC-FDMA symbol shall be counted in the PUSCH mapping but not used for transmission of PUSCH.

For a UE configured with SRS carrier switching, if the last symbol in a subframe is counted in the PUSCH mapping and the last symbol in the subframe overlaps with an SRS transmission (including any interruption due to uplink or

downlink RF retuning time) in a carrier without PUSCH/PUCCH, the resource elements in the last SC-FDMA symbol shall be counted in the PUSCH mapping but not used for transmission of PUSCH.

For a UE configured with SRS carrier switching, if the last symbol in a subframe is not counted in the PUSCH mapping and the second-to-last symbol in the subframe overlaps with an SRS transmission (including any interruption due to uplink or downlink RF retuning time) in a carrier without PUSCH/PUCCH, the resource elements in the second-to-last SC-FDMA symbol shall be counted in the PUSCH mapping but not used for transmission of PUSCH.

For a UE configured with PUSCH Mode 1, if DCI indicates PUSCH mode 1 enabled and the corresponding transmission of PUSCH starts in the second slot of a subframe, the resource elements in the first slot of the subframe shall be counted in the PUSCH mapping but not used for transmission of PUSCH.

For a UE configured with autonomous uplink,

- if the UE indicates PUSCH ending symbol '1' in uplink control information, or *endingSymbolAUL* is set to '12', the resource elements in the last SC-FDMA symbol shall be counted in the PUSCH mapping but not used for transmission of PUSCH;
- if the UE indicates PUSCH starting symbol '1' in uplink control information, the resource elements in the first SC-FDMA symbol shall be counted in the PUSCH mapping but not used for transmission of PUSCH.

If uplink frequency-hopping is disabled or the resource blocks allocated for PUSCH transmission are not contiguous in frequency, the set of physical resource blocks to be used for transmission is given by $n_{\text{PRB}} = n_{\text{VRB}}$ where n_{VRB} is obtained from the uplink scheduling grant as described in clause 8.1 in 3GPP TS 36.213 [4].

If uplink frequency-hopping with type 1 PUSCH hopping is enabled, the set of physical resource blocks to be used for transmission is given by clause 8.4.1 in 3GPP TS 36.213 [4].

If uplink frequency-hopping with predefined hopping pattern is enabled, the set of physical resource blocks to be used for transmission in slot n_s is given by the scheduling grant together with a predefined pattern according to

$$\begin{aligned} \tilde{n}_{\text{PRB}}(n_s) &= \left(\tilde{n}_{\text{VRB}} + f_{\text{hop}}(i) \cdot N_{\text{RB}}^{\text{sb}} + \left((N_{\text{RB}}^{\text{sb}} - 1) - 2(\tilde{n}_{\text{VRB}} \bmod N_{\text{RB}}^{\text{sb}}) \right) \cdot f_m(i) \right) \bmod (N_{\text{RB}}^{\text{sb}} \cdot N_{\text{sb}}) \\ i &= \begin{cases} \lfloor n_s/2 \rfloor & \text{inter - subframe hopping} \\ n_s & \text{intra and inter - subframe hopping} \end{cases} \\ n_{\text{PRB}}(n_s) &= \begin{cases} \tilde{n}_{\text{PRB}}(n_s) & N_{\text{sb}} = 1 \\ \tilde{n}_{\text{PRB}}(n_s) + \lceil N_{\text{RB}}^{\text{HO}}/2 \rceil & N_{\text{sb}} > 1 \end{cases} \\ \tilde{n}_{\text{VRB}} &= \begin{cases} n_{\text{VRB}} & N_{\text{sb}} = 1 \\ n_{\text{VRB}} - \lceil N_{\text{RB}}^{\text{HO}}/2 \rceil & N_{\text{sb}} > 1 \end{cases} \end{aligned}$$

where n_{VRB} is obtained from the scheduling grant as described in clause 8.1 in 3GPP TS 36.213 [4]. The parameter *pusch-HoppingOffset*, $N_{\text{RB}}^{\text{HO}}$, is provided by higher layers. The size $N_{\text{RB}}^{\text{sb}}$ of each sub-band is given by,

$$N_{\text{RB}}^{\text{sb}} = \begin{cases} N_{\text{RB}}^{\text{UL}} & N_{\text{sb}} = 1 \\ \left\lfloor \left(N_{\text{RB}}^{\text{UL}} - N_{\text{RB}}^{\text{HO}} - N_{\text{RB}}^{\text{HO}} \bmod 2 \right) / N_{\text{sb}} \right\rfloor & N_{\text{sb}} > 1 \end{cases}$$

where the number of sub-bands N_{sb} is given by higher layers. The function $f_m(i) \in \{0,1\}$ determines whether mirroring is used or not. The parameter *Hopping-mode* provided by higher layers determines if hopping is "inter-subframe" or "intra and inter-subframe".

The hopping function $f_{\text{hop}}(i)$ and the function $f_m(i)$ are given by

$$f_{\text{hop}}(i) = \begin{cases} 0 & N_{\text{sb}} = 1 \\ (f_{\text{hop}}(i-1) + \sum_{k=i-10+1}^{i-10+9} c(k) \times 2^{k-(i-10+1)}) \bmod N_{\text{sb}} & N_{\text{sb}} = 2 \\ (f_{\text{hop}}(i-1) + \left(\sum_{k=i-10+1}^{i-10+9} c(k) \times 2^{k-(i-10+1)} \right) \bmod (N_{\text{sb}} - 1) + 1) \bmod N_{\text{sb}} & N_{\text{sb}} > 2 \end{cases}$$

$$f_m(i) = \begin{cases} i \bmod 2 & N_{\text{sb}} = 1 \text{ and intra and inter - subframe hopping} \\ \text{CURRENT_TX_NB} \bmod 2 & N_{\text{sb}} = 1 \text{ and inter - subframe hopping} \\ c(i \cdot 10) & N_{\text{sb}} > 1 \end{cases}$$

where $f_{\text{hop}}(-1) = 0$ and the pseudo-random sequence $c(i)$ is given by clause 7.2 and CURRENT_TX_NB indicates the transmission number for the transport block transmitted in slot n_s as defined in [8]. The pseudo-random sequence generator shall be initialised with $c_{\text{init}} = N_{\text{ID}}^{\text{cell}}$ for frame structure type 1 and $c_{\text{init}} = 2^9 \cdot (n_f \bmod 4) + N_{\text{ID}}^{\text{cell}}$ for frame structure type 2 at the start of each frame.

For BL/CE UEs, the PRB resources for PUSCH transmission in the first subframe are obtained from the DCI as described in clauses 5.3.3.1.10 and 5.3.3.1.11 in [3]. Each of the $N_{TB} \geq 1$ PUSCH codewords is transmitted with $N_{\text{rep}}^{\text{PUSCH}} \geq 1$ repetitions, where N_{TB} is the number of transport blocks defined in clause 8.0 of 3GPP TS 36.213 [4]. The PUSCH transmission spans $N_{\text{abs}}^{\text{PUSCH}} \geq N_{TB} N_{\text{rep}}^{\text{PUSCH}}$ consecutive subframes, including subframes that are not BL/CE UL subframes where the UE postpones the PUSCH transmission if $N_{\text{rep}}^{\text{PUSCH}} > 1$.

- If higher layer parameter *resourceReservationDedicatedUL* is configured, and the Resource reservation field in the DCI is set to 1, then in case of PUSCH transmission with $N_{\text{rep}}^{\text{PUSCH}} > 1$ associated with C-RNTI or SPS C-RNTI using UE-specific MPDCCH search space including PUSCH transmission without a corresponding MPDCCH,
 - In a subframe that is fully reserved as defined in clause 8.0 in [4], the PUSCH transmission is postponed until the next BL/CE uplink subframe that is not fully reserved.
 - In a subframe that is partially reserved, the reserved SC-FDMA symbols shall be counted in the PUSCH mapping but not used for transmission of the PUSCH.
- In case the UE is a BL/CE UE configured with higher layer parameter *ce-PUSCH-SubPRB-Config-r15*, the PUSCH transmission spans $N_{\text{abs}}^{\text{PUSCH}} \geq N_{\text{rep}}^{\text{PUSCH}} M_{\text{RU}} M_{\text{slots}}^{\text{UL}} / 2$ consecutive subframes including subframes that are not BL/CE UL subframes where the UE postpones the PUSCH transmission.
- For BL/CE UE in CEModeA,
 - If PUSCH is transmitted using preconfigured uplink resources,
 - PUSCH frequency hopping is enabled when the higher layer parameter *pur-PUSCH-FreqHopping* is set, otherwise frequency hopping is disabled.
 - Else, if PUSCH scheduled by DCI format 6-0A is associated with PUR C-RNTI,
 - PUSCH frequency hopping is enabled when the higher layer parameter *pur-PUSCH-FreqHopping* is set and the frequency hopping flag in DCI format 6-0A indicates frequency hopping, otherwise frequency hopping is disabled.
 - Else,
 - PUSCH frequency hopping is enabled when the higher-layer parameter *pusch-HoppingConfig* is set and the frequency hopping flag in DCI format 6-0A indicates frequency hopping, otherwise frequency hopping is disabled.
- For BL/CE UE in CEModeB,
 - If PUSCH is transmitted using preconfigured uplink resources,

- PUSCH frequency hopping is enabled when the higher layer parameter *pur-PUSCH-FreqHopping* is set, otherwise frequency hopping is disabled.
- Else, if PUSCH scheduled by DCI format 6-0B is associated with PUR C-RNTI,
 - PUSCH frequency hopping is enabled when the higher layer parameter *pur-PUSCH-FreqHopping* is set, otherwise frequency hopping is disabled.
- Else,
 - PUSCH frequency hopping is enabled when the higher-layer parameter *pusch-HoppingConfig* is set, otherwise frequency hopping is disabled.
- If frequency hopping is not enabled for PUSCH, all PUSCH repetitions are located at the same PRB resources.
- If a BL/CE UE is configured with higher layer parameter *ce-PUSCH-FlexibleStartPRB-AllocConfig*, the UE is not expected to have the frequency hopping enabled for PUSCH with the resource allocation including the center PRB not belonging to any narrowband.
- If frequency hopping is enabled for PUSCH and the UE is not configured with CEModeA and higher layer parameter *ce-PUSCH-FlexibleStartPRB-AllocConfig*,
 - PUSCH is transmitted in uplink subframe i within the $N_{\text{abs}}^{\text{PUSCH}}$ consecutive subframes using the same number of consecutive PRBs as in the previous subframe starting from the PRB resources of the narrowband $n_{\text{NB}}^{(i)}$ with the same RIV as that of narrowband $n_{\text{NB}}^{(i_0)}$. The narrowband $n_{\text{NB}}^{(i)}$ is defined as

$$n_{\text{NB}}^{(i)} = \begin{cases} n_{\text{NB}}^{(i_0)} & \text{if } \lfloor i/N_{\text{NB}}^{\text{ch,UL}} - j_0 \rfloor \bmod 2 = 0 \\ (n_{\text{NB}}^{(i_0)} + f_{\text{NB,hop}}^{\text{PUSCH}}) \bmod N_{\text{NB}}^{\text{UL}} & \text{if } \lfloor i/N_{\text{NB}}^{\text{ch,UL}} - j_0 \rfloor \bmod 2 = 1 \end{cases}$$

$$j_0 = \lfloor i_0/N_{\text{NB}}^{\text{ch,UL}} \rfloor$$

$$i_0 \leq i \leq i_0 + N_{\text{abs}}^{\text{PUSCH}} - 1$$

where i_0 is the absolute subframe number of the first UL subframe intended for carrying the PUSCH and $N_{\text{NB}}^{\text{ch,UL}}$ and $f_{\text{NB,hop}}^{\text{PUSCH}}$ are cell-specific higher-layer parameters. For the $N_{\text{abs}}^{\text{PUSCH}}$ consecutive subframes, the UE shall not transmit PUSCH in subframe i if it is not a BL/CE UL subframe.

- If frequency hopping is enabled for PUSCH and the UE is configured with CEModeA and higher layer parameter *ce-PUSCH-FlexibleStartPRB-AllocConfig*,
 - Except when the PUSCH resource allocation includes the center PRB not belonging to any narrowband, PUSCH is transmitted in uplink subframe i within the $N_{\text{abs}}^{\text{PUSCH}}$ consecutive subframes using the same number of consecutive PRBs as in the previous subframe, where $n_{\text{NB}}^{(i_0)}$ is the narrowband index that starting PRB located in the absolute subframe number of the first UL subframe i_0 , defined as
 - If $N_{\text{RB}}^{\text{UL}} \bmod 2 = 0$ or $N_{\text{RB}}^{\text{UL}} \bmod 2 = 1$ with $RB_{\text{START}} < \lfloor N_{\text{RB}}^{\text{UL}}/2 \rfloor$, $n_{\text{NB}}^{(i_0)} = \lfloor \frac{RB_{\text{START}} - l_e}{6} \rfloor$
 - If $N_{\text{RB}}^{\text{UL}} \bmod 2 = 1$ with $RB_{\text{START}} > \lfloor N_{\text{RB}}^{\text{UL}}/2 \rfloor$, $n_{\text{NB}}^{(i_0)} = \lfloor \frac{RB_{\text{START}} - l_e - 1}{6} \rfloor$

where $l_e = \lfloor \frac{N_{\text{RB}}^{\text{UL}}}{2} \rfloor - \frac{6N_{\text{NB}}^{\text{UL}}}{2}$ is the number of edge PRB(s) not belonging to narrowbands in one side of system bandwidth $N_{\text{RB}}^{\text{UL}}$, $N_{\text{NB}}^{\text{UL}}$ is the number of narrowbands, the starting PRB index RB_{START} and the length L_{CRBs} of the allocated resources are defined in clause 8.1.1 of [4]. After hopping, the narrowband $n_{\text{NB}}^{(i)}$ in subframe i is defined as

$$n_{NB}^{(i)} = \begin{cases} n_{NB}^{(i_0)} & \text{if } \left\lfloor \frac{i}{N_{NB}^{ch,UL}} - j_0 \right\rfloor \bmod 2 = 0 \\ \left(n_{NB}^{(i_0)} + f_{NB,hop}^{PUSCH} \right) \bmod N_{NB}^{UL} & \text{if } \left\lfloor \frac{i}{N_{NB}^{ch,UL}} - j_0 \right\rfloor \bmod 2 = 1 \end{cases}$$

$$j_0 = \left\lfloor \frac{i_0}{N_{NB}^{ch,UL}} \right\rfloor$$

$$i_0 \leq i \leq i_0 + N_{abs}^{PUSCH} - 1$$

where $N_{NB}^{ch,UL}$ and $f_{NB,hop}^{PUSCH}$ are cell-specific higher-layer parameters. For the N_{abs}^{PUSCH} consecutive subframes, the UE shall not transmit PUSCH in subframe i if it is not a BL/CE UL subframe. After hopping, the resource blocks have the same relative location of starting PRB in $n_{NB}^{(i)}$ as in narrowband $n_{NB}^{(i_0)}$.

- If frequency hopping is enabled for PUSCH and the UE is configured with higher layer parameter *ce-PUSCH-FlexibleStartPRB-AllocConfig*,
 - If a frequency hopping leads to a split resource allocation, where some PRB(s) is (are) on one edge and some PRB(s) is (are) on the other edge of the system bandwidth, the PUSCH transmission is dropped in that subframe.
 - If a frequency hopping leads to a resource allocation, where some PRB(s) is (are) not belonging to any narrowband, the PUSCH transmission is dropped in that subframe.

For BL/CE UEs, for PUSCH transmission corresponding to the random access response grant and its retransmission, frequency hopping of the PUSCH is enabled when higher layer parameter *rar-HoppingConfig* is set. Further

- if PRACH CE level 0 or 1 is used for the last PRACH attempt, $N_{NB}^{ch,UL}$ is set to the higher layer parameter *interval-ULHoppingConfigCommonModeA*;
- if PRACH CE level 2 or 3 is used for the last PRACH attempt, $N_{NB}^{ch,UL}$ is set to the higher layer parameter *interval-ULHoppingConfigCommonModeB*.

For BL/CE UEs in CEModeB, for PUSCH transmission not associated with Temporary C-RNTI, for frame structure type 1, after a transmission duration of $256 \cdot 30720T_s$ time units (which may include subframes that are not BL/CE UL subframes), a gap of $40 \cdot 30720T_s$ time units shall be inserted, according to the UE capability *ue-CE-NeedULGaps*, as specified in 3GPP TS 36.331 [9]. BL/CE UL subframes within the gap of $40 \cdot 30720T_s$ time units shall be counted for the PUSCH resource mapping but not used for transmission of the PUSCH.

For BL/CE UEs, for PUSCH transmission associated with Temporary C-RNTI for frame structure type 1, and if PRACH CE level 2 or 3 is used for the last PRACH attempt, after a transmission duration of $256 \cdot 30720T_s$ time units (which may include subframes that are not BL/CE UL subframes), a gap of $40 \cdot 30720T_s$ time units shall be inserted. BL/CE UL subframes within the gap of $40 \cdot 30720T_s$ time units shall be counted for the PUSCH resource mapping but not used for transmission of the PUSCH.

For UEs configured with *PUSCH-EnhancementsConfig*, the number of PUSCH subframe repetitions N_{rep}^{PUSCH} and the PRB resources for PUSCH transmission in the first subframe are obtained from the DCI as described in clause 5.3.3.1.1C in [3]. The PUSCH transmission spans $N_{abs}^{PUSCH} \geq N_{rep}^{PUSCH}$ consecutive subframes, including DL subframes where the UE postpones the PUSCH transmission in the case of frame structure type 2. PUSCH frequency hopping is enabled when the higher-layer parameters *pusch-HoppingOffsetPUSCH-Enh* and *interval-ULHoppingPUSCH-Enh* are set and the frequency hopping flag in DCI format 0C indicates frequency hopping, otherwise frequency hopping is disabled. If frequency hopping is not enabled for PUSCH, the PUSCH repetitions are located at the same PRB resources as in the first subframe. If frequency hopping is enabled for PUSCH, PUSCH is transmitted in uplink subframe i within the N_{rep}^{PUSCH} consecutive subframes using the PRB resources starting at PRB index $n_{PRB}^{(i)}$

$$n_{PRB}^{(i)} = \begin{cases} n_{PRB}^{(i_0)} & \text{if } \left\lfloor \frac{i}{N_{PRB,hop}^{PUSCH}} - j_0 \right\rfloor \bmod 2 = 0 \\ \left(n_{PRB}^{(i_0)} + f_{PRB,hop}^{PUSCH} \right) \bmod N_{PRB}^{UL} & \text{if } \left\lfloor \frac{i}{N_{PRB,hop}^{PUSCH}} - j_0 \right\rfloor \bmod 2 = 1 \end{cases}$$

$$j_0 = \left\lfloor \frac{i_0}{N_{\text{PRB,hop}}^{\text{PUSCH}}} \right\rfloor, i_0 \leq i \leq i_0 + N_{\text{abs}}^{\text{PUSCH}} - 1$$

where i_0 is the absolute subframe number of the first UL subframe carrying the PUSCH and $N_{\text{PRB,hop}}^{\text{PUSCH}}$ is given by the higher-layer parameter *interval-ULHoppingPUSCH-Enh* and $f_{\text{PRB,hop}}^{\text{PUSCH}}$ is given by the higher-layer parameter *pusch-HoppingOffsetPUSCH-Enh*.

5.4 Physical uplink control channel

The physical uplink control channel, PUCCH, carries uplink control information. Simultaneous transmission of PUCCH and PUSCH from the same UE is supported if enabled by higher layers. For frame structure type 2, the PUCCH is not transmitted in the UpPTS field.

The physical uplink control channel supports multiple formats as shown in Table 5.4-1 with different number of bits per subframe, where $M_{\text{RB}}^{\text{PUCCH4}}$ represents the bandwidth of the PUCCH format 4 as defined by clause 5.4.2B, and N_0^{PUCCH} and N_1^{PUCCH} are defined in Table 5.4.2C-1.

Formats 2a and 2b are supported for normal cyclic prefix only.

Table 5.4-1: Supported PUCCH formats

PUCCH format	Modulation scheme	Number of bits per subframe, M_{bit}
1	N/A	N/A
1a	BPSK	1
1b	QPSK	2
2	QPSK	20
2a	QPSK+BPSK	21
2b	QPSK+QPSK	22
3	QPSK	48
4	QPSK	$M_{\text{RB}}^{\text{PUCCH4}} \cdot N_{\text{sc}}^{\text{RB}} \cdot (N_0^{\text{PUCCH}} + N_1^{\text{PUCCH}}) \cdot 2$
5	QPSK	$N_{\text{sc}}^{\text{RB}} \cdot (N_0^{\text{PUCCH}} + N_1^{\text{PUCCH}})$

All PUCCH formats use a cyclic shift, $n_{\text{cs}}^{\text{cell}}(n_s, l)$, which varies with the symbol number l and the slot number n_s according to

$$n_{\text{cs}}^{\text{cell}}(n_s, l) = \sum_{i=0}^7 c(8N_{\text{symb}}^{\text{UL}} \cdot n_s + 8l + i) \cdot 2^i$$

where the pseudo-random sequence $c(i)$ is defined by clause 7.2. The pseudo-random sequence generator shall be initialized with $c_{\text{init}} = n_{\text{ID}}^{\text{RS}}$, where $n_{\text{ID}}^{\text{RS}}$ is given by clause 5.5.1.5 with $N_{\text{ID}}^{\text{cell}}$ corresponding to the primary cell, at the beginning of each radio frame.

The physical resources used for PUCCH format 1/1a/1b and PUCCH format 2/2a/2b depends on two parameters, $N_{\text{RB}}^{(2)}$ and $N_{\text{cs}}^{(1)}$, given by higher layers.

The variable $N_{\text{RB}}^{(2)} \geq 0$ denotes the bandwidth in terms of resource blocks that are available for use by PUCCH formats 2/2a/2b transmission in each slot. The variable $N_{\text{cs}}^{(1)}$ denotes the number of cyclic shift used for PUCCH formats 1/1a/1b in a resource block used for a mix of formats 1/1a/1b and 2/2a/2b. The value of $N_{\text{cs}}^{(1)}$ is an integer multiple of $\Delta_{\text{shift}}^{\text{PUCCH}}$ within the range of $\{0, 1, \dots, 7\}$, where $\Delta_{\text{shift}}^{\text{PUCCH}}$ is provided by higher layers. No mixed resource block is present if $N_{\text{cs}}^{(1)} = 0$. At most one resource block in each slot supports a mix of formats 1/1a/1b and 2/2a/2b.

Resources used for transmission of PUCCH formats 1/1a/1b, 2/2a/2b, 3, 4, and 5 are represented by the non-negative

indices $n_{\text{PUCCH}}^{(1,\tilde{p})}$, $n_{\text{PUCCH}}^{(2,\tilde{p})} < N_{\text{RB}}^{(2)} N_{\text{sc}}^{\text{RB}} + \left\lceil \frac{N_{\text{cs}}^{(1)}}{8} \right\rceil \cdot (N_{\text{sc}}^{\text{RB}} - N_{\text{cs}}^{(1)} - 2)$, $n_{\text{PUCCH}}^{(3,\tilde{p})}$, $n_{\text{PUCCH}}^{(4)}$ and $n_{\text{PUCCH}}^{(5)}$, respectively.

5.4.1 PUCCH formats 1, 1a and 1b

For PUCCH format 1, information is carried by the presence/absence of transmission of PUCCH from the UE. In the remainder of this clause, $d(0) = 1$ shall be assumed for PUCCH format 1.

For PUCCH formats 1a and 1b, one or two explicit bits are transmitted, respectively. The block of bits $b(0), \dots, b(M_{\text{bit}} - 1)$ shall be modulated as described in Table 5.4.1-1, resulting in a complex-valued symbol $d(0)$. The modulation schemes for the different PUCCH formats are given by Table 5.4-1.

The complex-valued symbol $d(0)$ shall be multiplied with a cyclically shifted length $N_{\text{seq}}^{\text{PUCCH}} = 12$ sequence $r_{u,v}^{(\alpha_{\tilde{p}})}(n)$ for each of the P antenna ports used for PUCCH transmission according to

$$y^{(\tilde{p}, \delta)}(n) = \frac{1}{\sqrt{P}} d(0) \cdot r_{u,v}^{(\alpha_{\tilde{p}}, \delta)}(n), \quad n = 0, 1, \dots, N_{\text{seq}}^{\text{PUCCH}} - 1$$

where $r_{u,v}^{(\alpha_{\tilde{p}}, \delta)}(n)$ is defined by clause 5.5.1 with $M_{\text{sc}}^{\text{RS}} = N_{\text{seq}}^{\text{PUCCH}}$ and $\delta = 0$. The antenna-port specific cyclic shift $\alpha_{\tilde{p}}$ varies between symbols and slots as defined below.

The block of complex-valued symbols $y^{(\tilde{p})}(0), \dots, y^{(\tilde{p})}(N_{\text{seq}}^{\text{PUCCH}} - 1)$ shall be scrambled by $S(n_s)$ and block-wise spread with the antenna-port specific orthogonal sequence $w_{n_{\text{oc}}^{(\tilde{p})}}(i)$ according to

$$z^{(\tilde{p})}(m' \cdot N_{\text{SF}}^{\text{PUCCH}} \cdot N_{\text{seq}}^{\text{PUCCH}} + m \cdot N_{\text{seq}}^{\text{PUCCH}} + n) = S(n_s) \cdot w_{n_{\text{oc}}^{(\tilde{p})}}(m) \cdot y^{(\tilde{p})}(n)$$

where

$$\begin{aligned} m &= 0, \dots, N_{\text{SF}}^{\text{PUCCH}} - 1 \\ n &= 0, \dots, N_{\text{seq}}^{\text{PUCCH}} - 1 \\ m' &= 0, 1 \end{aligned}$$

and

$$S(n_s) = \begin{cases} 1 & \text{if } n_{\tilde{p}}'(n_s) \bmod 2 = 0 \\ e^{j\pi/2} & \text{otherwise} \end{cases}$$

with $N_{\text{SF}}^{\text{PUCCH}}$ for the two slots in a subframe given by Table 5.4.1-1a. The sequence $w_{n_{\text{oc}}^{(\tilde{p})}}(i)$ is given by Table 5.4.1-2 and Table 5.4.1-3 and $n_{\tilde{p}}'(n_s)$ is defined below.

Resources used for transmission of PUCCH format 1, 1a and 1b are identified by a resource index $n_{\text{PUCCH}}^{(1, \tilde{p})}$ from which the orthogonal sequence index $n_{\text{oc}}^{(\tilde{p})}(n_s)$ and the cyclic shift $\alpha_{\tilde{p}}(n_s, l)$ are determined according to

$$n_{\text{oc}}^{(\tilde{p})}(n_s) = \begin{cases} \left\lfloor n_{\tilde{p}}'(n_s) \cdot \Delta_{\text{shift}}^{\text{PUCCH}} / N' \right\rfloor & \text{for normal cyclic prefix} \\ 2 \cdot \left\lfloor n_{\tilde{p}}'(n_s) \cdot \Delta_{\text{shift}}^{\text{PUCCH}} / N' \right\rfloor & \text{for extended cyclic prefix} \end{cases}$$

$$\alpha_{\tilde{p}}(n_s, l) = 2\pi \cdot n_{\text{cs}}^{(\tilde{p})}(n_s, l) / N_{\text{sc}}^{\text{RB}}$$

$$n_{\text{cs}}^{(\tilde{p})}(n_s, l) = \begin{cases} \left[\left[n_{\text{cs}}^{\text{cell}}(n_s, l) + \left(n_{\tilde{p}}'(n_s) \cdot \Delta_{\text{shift}}^{\text{PUCCH}} + \left(n_{\text{oc}}^{(\tilde{p})}(n_s) \bmod \Delta_{\text{shift}}^{\text{PUCCH}} \right) \right) \bmod N' \right] \bmod N_{\text{sc}}^{\text{RB}} \right] & \text{for normal cyclic prefix} \\ \left[\left[n_{\text{cs}}^{\text{cell}}(n_s, l) + \left(n_{\tilde{p}}'(n_s) \cdot \Delta_{\text{shift}}^{\text{PUCCH}} + n_{\text{oc}}^{(\tilde{p})}(n_s) / 2 \right) \bmod N' \right] \bmod N_{\text{sc}}^{\text{RB}} \right] & \text{for extended cyclic prefix} \end{cases}$$

where

$$N' = \begin{cases} N_{cs}^{(1)} & \text{if } n_{PUCCH}^{(1,\tilde{p})} < c \cdot N_{cs}^{(1)} / \Delta_{shift}^{PUCCH} \\ N_{sc}^{RB} & \text{otherwise} \end{cases}$$

$$c = \begin{cases} 3 & \text{normal cyclic prefix} \\ 2 & \text{extended cyclic prefix} \end{cases}$$

The resource indices within the two resource blocks in the two slots of a subframe to which the PUCCH is mapped are given by

$$n'_{\tilde{p}}(n_s) = \begin{cases} n_{PUCCH}^{(1,\tilde{p})} & \text{if } n_{PUCCH}^{(1,\tilde{p})} < c \cdot N_{cs}^{(1)} / \Delta_{shift}^{PUCCH} \\ \left(n_{PUCCH}^{(1,\tilde{p})} - c \cdot N_{cs}^{(1)} / \Delta_{shift}^{PUCCH} \right) \bmod \left(c \cdot N_{sc}^{RB} / \Delta_{shift}^{PUCCH} \right) & \text{otherwise} \end{cases}$$

for $n_s \bmod 2 = 0$ and by

$$n'_{\tilde{p}}(n_s) = \begin{cases} \left[\left[c(n'_{\tilde{p}}(n_s - 1) + 1) \right] \bmod \left(cN_{sc}^{RB} / \Delta_{shift}^{PUCCH} + 1 \right) - 1 \right] & n_{PUCCH}^{(1,\tilde{p})} \geq c \cdot N_{cs}^{(1)} / \Delta_{shift}^{PUCCH} \\ \left\lfloor h_{\tilde{p}} / c \right\rfloor + (h_{\tilde{p}} \bmod c) N' / \Delta_{shift}^{PUCCH} & \text{otherwise} \end{cases}$$

for $n_s \bmod 2 = 1$, where $h_{\tilde{p}} = (n'_{\tilde{p}}(n_s - 1) + d) \bmod (cN' / \Delta_{shift}^{PUCCH})$, with $d = 2$ for normal CP and $d = 0$ for extended CP.

The parameter *deltaPUCCH-Shift* Δ_{shift}^{PUCCH} is provided by higher layers.

Table 5.4.1-1: Modulation symbol $d(0)$ for PUCCH formats 1a and 1b

PUCCH format	$b(0), \dots, b(M_{bit} - 1)$	$d(0)$
1a	0	1
	1	-1
1b	00	1
	01	-j
	10	j
	11	-1

Table 5.4.1-1a: The quantity N_{SF}^{PUCCH} for PUCCH formats 1a and 1b

PUCCH format	N_{SF}^{PUCCH}	
	first slot	second slot
normal 1/1a/1b	4	4
shortened 1/1a/1b	4	3

Table 5.4.1-2: Orthogonal sequences $[w(0) \dots w(N_{SF}^{PUCCH} - 1)]$ for $N_{SF}^{PUCCH} = 4$

Sequence index $n_{oc}^{(\tilde{p})}(n_s)$	Orthogonal sequences $[w(0) \dots w(N_{SF}^{PUCCH} - 1)]$
0	[+1 +1 +1 +1]
1	[+1 -1 +1 -1]
2	[+1 -1 -1 +1]

Table 5.4.1-3: Orthogonal sequences $[w(0) \dots w(N_{\text{SF}}^{\text{PUCCH}} - 1)]$ for $N_{\text{SF}}^{\text{PUCCH}} = 3$

Sequence index $n_{\text{oc}}^{(\tilde{p})}(n_s)$	Orthogonal sequences $[w(0) \dots w(N_{\text{SF}}^{\text{PUCCH}} - 1)]$
0	$[1 \ 1 \ 1]$
1	$[1 \ e^{j2\pi/3} \ e^{j4\pi/3}]$
2	$[1 \ e^{j4\pi/3} \ e^{j2\pi/3}]$

5.4.2 PUCCH formats 2, 2a and 2b

The block of bits $b(0), \dots, b(19)$ shall be scrambled with a UE-specific scrambling sequence, resulting in a block of scrambled bits $\tilde{b}(0), \dots, \tilde{b}(19)$ according to

$$\tilde{b}(i) = (b(i) + c(i)) \bmod 2$$

where the scrambling sequence $c(i)$ is given by clause 7.2. The scrambling sequence generator shall be initialised with $c_{\text{init}} = (\lfloor n_s/2 \rfloor + 1) \cdot (2N_{\text{ID}}^{\text{cell}} + 1) \cdot 2^{16} + n_{\text{RNTI}}$ at the start of each subframe where n_{RNTI} is C-RNTI.

The block of scrambled bits $\tilde{b}(0), \dots, \tilde{b}(19)$ shall be QPSK modulated as described in clause 7.1, resulting in a block of complex-valued modulation symbols $d(0), \dots, d(9)$.

Each complex-valued symbol $d(0), \dots, d(9)$ shall be multiplied with a cyclically shifted length $N_{\text{seq}}^{\text{PUCCH}} = 12$ sequence $r_{u,v}^{(\alpha_{\tilde{p}}, \delta)}(n)$ for each of the P antenna ports used for PUCCH transmission according to

$$z^{(\tilde{p})}(N_{\text{seq}}^{\text{PUCCH}} \cdot n + i) = \frac{1}{\sqrt{P}} d(n) \cdot r_{u,v}^{(\alpha_{\tilde{p}}, \delta)}(i)$$

$$n = 0, 1, \dots, 9$$

$$i = 0, 1, \dots, N_{\text{sc}}^{\text{RB}} - 1$$

where $r_{u,v}^{(\alpha_{\tilde{p}}, \delta)}(i)$ is defined by clause 5.5.1 with $M_{\text{sc}}^{\text{RS}} = N_{\text{seq}}^{\text{PUCCH}}$ and $\delta = 0$.

Resources used for transmission of PUCCH formats 2/2a/2b are identified by a resource index $n_{\text{PUCCH}}^{(2, \tilde{p})}$ from which the cyclic shift $\alpha_{\tilde{p}}(n_s, l)$ is determined according to

$$\alpha_{\tilde{p}}(n_s, l) = 2\pi \cdot n_{\text{cs}}^{(\tilde{p})}(n_s, l) / N_{\text{sc}}^{\text{RB}}$$

where

$$n_{\text{cs}}^{(\tilde{p})}(n_s, l) = (n_{\text{cs}}^{\text{cell}}(n_s, l) + n'_{\tilde{p}}(n_s)) \bmod N_{\text{sc}}^{\text{RB}}$$

and

$$n'_{\tilde{p}}(n_s) = \begin{cases} n_{\text{PUCCH}}^{(2, \tilde{p})} \bmod N_{\text{sc}}^{\text{RB}} & \text{if } n_{\text{PUCCH}}^{(2, \tilde{p})} < N_{\text{sc}}^{\text{RB}} N_{\text{RB}}^{(2)} \\ (n_{\text{PUCCH}}^{(2, \tilde{p})} + N_{\text{cs}}^{(1)} + 1) \bmod N_{\text{sc}}^{\text{RB}} & \text{otherwise} \end{cases}$$

for $n_s \bmod 2 = 0$ and by

$$n'_{\tilde{p}}(n_s) = \begin{cases} \left[\left\lfloor \frac{N_{\text{sc}}^{\text{RB}} (n'_{\tilde{p}}(n_s - 1) + 1)}{N_{\text{sc}}^{\text{RB}} + 1} \right\rfloor \right] \bmod (N_{\text{sc}}^{\text{RB}} + 1) - 1 & \text{if } n_{\text{PUCCH}}^{(2, \tilde{p})} < N_{\text{sc}}^{\text{RB}} N_{\text{RB}}^{(2)} \\ (N_{\text{sc}}^{\text{RB}} - 2 - n_{\text{PUCCH}}^{(2, \tilde{p})}) \bmod N_{\text{sc}}^{\text{RB}} & \text{otherwise} \end{cases}$$

for $n_s \bmod 2 = 1$.

For PUCCH formats 2a and 2b, supported for normal cyclic prefix only, the bit(s) $b(20), \dots, b(M_{\text{bit}} - 1)$ shall be modulated as described in Table 5.4.2-1 resulting in a single modulation symbol $d(10)$ used in the generation of the reference-signal for PUCCH format 2a and 2b as described in clause 5.5.2.2.1.

Table 5.4.2-1: Modulation symbol $d(10)$ for PUCCH formats 2a and 2b

PUCCH format	$b(20), \dots, b(M_{\text{bit}} - 1)$	$d(10)$
2a	0	1
	1	-1
2b	00	1
	01	$-j$
	10	j
	11	-1

5.4.2A PUCCH format 3

The block of bits $b(0), \dots, b(M_{\text{bit}} - 1)$ shall be scrambled with a UE-specific scrambling sequence, resulting in a block of scrambled bits $\tilde{b}(0), \dots, \tilde{b}(M_{\text{bit}} - 1)$ according to

$$\tilde{b}(i) = (b(i) + c(i)) \bmod 2$$

where the scrambling sequence $c(i)$ is given by clause 7.2. The scrambling sequence generator shall be initialised with $c_{\text{init}} = (\lfloor n_s/2 \rfloor + 1) \cdot (2N_{\text{ID}}^{\text{cell}} + 1) \cdot 2^{16} + n_{\text{RNTI}}$ at the start of each subframe where n_{RNTI} is the C-RNTI.

The block of scrambled bits $\tilde{b}(0), \dots, \tilde{b}(M_{\text{bit}} - 1)$ shall be QPSK modulated as described in Clause 7.1, resulting in a block of complex-valued modulation symbols $d(0), \dots, d(M_{\text{symb}} - 1)$ where $M_{\text{symb}} = M_{\text{bit}}/2 = 2N_{\text{sc}}^{\text{RB}}$.

The complex-valued symbols $d(0), \dots, d(M_{\text{symb}} - 1)$ shall be block-wise spread with the orthogonal sequences $w_{n_{\text{oc},0}}^{(\tilde{p})}(i)$ and $w_{n_{\text{oc},1}}^{(\tilde{p})}(i)$ resulting in $N_{\text{SF},0}^{\text{PUCCH}} + N_{\text{SF},1}^{\text{PUCCH}}$ sets of $N_{\text{sc}}^{\text{RB}}$ values each according to

$$y_n^{(\tilde{p})}(i) = \begin{cases} w_{n_{\text{oc},0}}^{(\tilde{p})}(\bar{n}) \cdot e^{j\pi \lfloor n_{\text{cs}}^{\text{cell}}(n_s, l)/64 \rfloor / 2} \cdot d(i) & n < N_{\text{SF},0}^{\text{PUCCH}} \\ w_{n_{\text{oc},1}}^{(\tilde{p})}(\bar{n}) \cdot e^{j\pi \lfloor n_{\text{cs}}^{\text{cell}}(n_s, l)/64 \rfloor / 2} \cdot d(N_{\text{sc}}^{\text{RB}} + i) & \text{otherwise} \end{cases}$$

$$\bar{n} = n \bmod N_{\text{SF},0}^{\text{PUCCH}}$$

$$n = 0, \dots, N_{\text{SF},0}^{\text{PUCCH}} + N_{\text{SF},1}^{\text{PUCCH}} - 1$$

$$i = 0, 1, \dots, N_{\text{sc}}^{\text{RB}} - 1$$

where $N_{\text{SF},0}^{\text{PUCCH}} = N_{\text{SF},1}^{\text{PUCCH}} = 5$ for both slots in a subframe using normal PUCCH format 3 and $N_{\text{SF},0}^{\text{PUCCH}} = 5$, $N_{\text{SF},1}^{\text{PUCCH}} = 4$ holds for the first and second slot, respectively, in a subframe using shortened PUCCH format 3. The orthogonal sequences $w_{n_{\text{oc},0}}^{(\tilde{p})}(i)$ and $w_{n_{\text{oc},1}}^{(\tilde{p})}(i)$ are given by Table 5.4.2A-1. Resources used for transmission of PUCCH format 3 are identified by a resource index $n_{\text{PUCCH}}^{(3, \tilde{p})}$ from which the quantities $n_{\text{oc},0}^{(\tilde{p})}$ and $n_{\text{oc},1}^{(\tilde{p})}$ are derived according to

$$n_{\text{oc},0}^{(\tilde{p})} = n_{\text{PUCCH}}^{(3, \tilde{p})} \bmod N_{\text{SF},1}^{\text{PUCCH}}$$

$$n_{\text{oc},1}^{(\tilde{p})} = \begin{cases} (3n_{\text{oc},0}^{(\tilde{p})}) \bmod N_{\text{SF},1}^{\text{PUCCH}} & \text{if } N_{\text{SF},1}^{\text{PUCCH}} = 5 \\ n_{\text{oc},0}^{(\tilde{p})} \bmod N_{\text{SF},1}^{\text{PUCCH}} & \text{otherwise} \end{cases}$$

Each set of complex-valued symbols shall be cyclically shifted according to

$$\tilde{y}_n^{(\tilde{p})}(i) = y_n^{(\tilde{p})} \left((i + n_{\text{cs}}^{\text{cell}}(n_s, l)) \bmod N_{\text{sc}}^{\text{RB}} \right)$$

where $n_{\text{cs}}^{\text{cell}}(n_s, l)$ is given by Clause 5.4, n_s is the slot number within a radio frame and l is the SC-FDMA symbol number within a slot.

The shifted sets of complex-valued symbols shall be transform precoded according to

$$z^{(\tilde{p})}(n \cdot N_{sc}^{RB} + k) = \frac{1}{\sqrt{P}} \frac{1}{\sqrt{N_{sc}^{RB}}} \sum_{i=0}^{N_{sc}^{RB}-1} \tilde{y}_n^{(\tilde{p})}(i) e^{-j \frac{2\pi k i}{N_{sc}^{RB}}}$$

$$k = 0, \dots, N_{sc}^{RB} - 1$$

$$n = 0, \dots, N_{SF,0}^{PUCCH} + N_{SF,1}^{PUCCH} - 1$$

where P is the number of antenna ports used for PUCCH transmission, resulting in a block of complex-valued symbols $z^{(\tilde{p})}(0), \dots, z^{(\tilde{p})}((N_{SF,0}^{PUCCH} + N_{SF,1}^{PUCCH})N_{sc}^{RB} - 1)$.

Table 5.4.2A-1: The orthogonal sequence $w_{n_{oc}}(i)$

Sequence index n_{oc}	Orthogonal sequence $[w_{n_{oc}}(0) \ \dots \ w_{n_{oc}}(N_{SF}^{PUCCH} - 1)]$	
	$N_{SF}^{PUCCH} = 5$	$N_{SF}^{PUCCH} = 4$
0	[1 1 1 1 1]	[+1 +1 +1 +1]
1	[1 $e^{j2\pi/5}$ $e^{j4\pi/5}$ $e^{j6\pi/5}$ $e^{j8\pi/5}$]	[+1 -1 +1 -1]
2	[1 $e^{j4\pi/5}$ $e^{j8\pi/5}$ $e^{j2\pi/5}$ $e^{j6\pi/5}$]	[+1 +1 -1 -1]
3	[1 $e^{j6\pi/5}$ $e^{j2\pi/5}$ $e^{j8\pi/5}$ $e^{j4\pi/5}$]	[+1 -1 -1 +1]
4	[1 $e^{j8\pi/5}$ $e^{j6\pi/5}$ $e^{j4\pi/5}$ $e^{j2\pi/5}$]	-

5.4.2B PUCCH format 4

The block of bits $b(0), \dots, b(M_{\text{bit}} - 1)$ shall be scrambled with a UE-specific scrambling sequence, resulting in a block of scrambled bits $\tilde{b}(0), \dots, \tilde{b}(M_{\text{bit}} - 1)$ according to

$$\tilde{b}(i) = (b(i) + c(i)) \bmod 2$$

where the scrambling sequence $c(i)$ is given by clause 7.2. The scrambling sequence generator shall be initialised with $c_{\text{init}} = (\lfloor n_s/2 \rfloor + 1) \cdot (2N_{\text{ID}}^{\text{cell}} + 1) \cdot 2^{16} + n_{\text{RNTI}}$ at the start of each subframe where n_{RNTI} is the C-RNTI.

The block of scrambled bits $\tilde{b}(0), \dots, \tilde{b}(M_{\text{bit}} - 1)$ shall be QPSK modulated as described in Clause 7.1, resulting in a block of complex-valued modulation symbols $d(0), \dots, d(M_{\text{symb}} - 1)$ where $M_{\text{symb}} = M_{\text{bit}}/2$.

The block of complex-valued symbols $d(0), \dots, d(M_{\text{symb}} - 1)$ is divided into $N_0^{\text{PUCCH}} + N_1^{\text{PUCCH}}$ sets, each corresponding to one SC-FDMA symbol. Transform precoding shall be applied according to

$$z^{(\tilde{p})}(l \cdot M_{\text{sc}}^{\text{PUCCH4}} + k) = \frac{1}{\sqrt{M_{\text{sc}}^{\text{PUCCH4}}}} \sum_{i=0}^{M_{\text{sc}}^{\text{PUCCH4}} - 1} d(l \cdot M_{\text{sc}}^{\text{PUCCH4}} + i) e^{-j \frac{2\pi k i}{M_{\text{sc}}^{\text{PUCCH4}}}}$$

$$k = 0, \dots, M_{\text{sc}}^{\text{PUCCH4}} - 1$$

$$l = 0, \dots, N_0^{\text{PUCCH}} + N_1^{\text{PUCCH}} - 1$$

where $\tilde{p} = 0$, N_0^{PUCCH} and N_1^{PUCCH} are given by Table 5.4.2C-1 for normal PUCCH format 4 and shortened PUCCH format 4, resulting in a block of complex-valued symbols $z^{(\tilde{p})}(0), \dots, z^{(\tilde{p})}(M_{\text{symb}} - 1)$. The variable

$M_{\text{sc}}^{\text{PUCCH4}} = M_{\text{RB}}^{\text{PUCCH4}} \cdot N_{\text{sc}}^{\text{RB}}$, where $M_{\text{RB}}^{\text{PUCCH4}}$ represents the bandwidth of the PUCCH format 4 in terms of resource blocks, shall fulfil

$$M_{\text{RB}}^{\text{PUCCH4}} = 2^{\alpha_2} \cdot 3^{\alpha_3} \cdot 5^{\alpha_5} \leq N_{\text{RB}}^{\text{UL}}$$

where $\alpha_2, \alpha_3, \alpha_5$ is a set of non-negative integers.

5.4.2C PUCCH format 5

The block of bits $b(0), \dots, b(M_{\text{bit}} - 1)$ shall be scrambled with a UE-specific scrambling sequence, resulting in a block of scrambled bits $\tilde{b}(0), \dots, \tilde{b}(M_{\text{bit}} - 1)$ according to

$$\tilde{b}(i) = (b(i) + c(i)) \bmod 2$$

where the scrambling sequence $c(i)$ is given by clause 7.2. The scrambling sequence generator shall be initialised with $c_{\text{init}} = (\lfloor n_s/2 \rfloor + 1) \cdot (2N_{\text{ID}}^{\text{cell}} + 1) \cdot 2^{16} + n_{\text{RNTI}}$ at the start of each subframe where n_{RNTI} is the C-RNTI.

The block of scrambled bits $\tilde{b}(0), \dots, \tilde{b}(M_{\text{bit}} - 1)$ shall be QPSK modulated as described in Clause 7.1, resulting in a block of complex-valued modulation symbols $d(0), \dots, d(M_{\text{symb}} - 1)$ where $M_{\text{symb}} = M_{\text{bit}}/2$.

The complex-valued symbols $d(0), \dots, d(M_{\text{symb}} - 1)$ shall be divided into $N_0^{\text{PUCCH}} + N_1^{\text{PUCCH}}$ sets, each corresponding to one SC-FDMA symbol. Block-wise spreading shall be applied according to

$$y_n(i) = w_{n_{\text{oc}}}(i) \cdot d(i \bmod N_{\text{sc}}^{\text{RB}} / N_{\text{SF}}^{\text{PUCCH}} + n \cdot N_{\text{sc}}^{\text{RB}} / N_{\text{SF}}^{\text{PUCCH}})$$

$$n = 0, \dots, N_0^{\text{PUCCH}} + N_1^{\text{PUCCH}} - 1$$

$$i = 0, 1, \dots, N_{\text{sc}}^{\text{RB}} - 1$$

where $N_{SF}^{PUCCH} = 2$, N_0^{PUCCH} and N_1^{PUCCH} are given by Table 5.4.2C-1 for normal PUCCH format 5 and shortened PUCCH format 5, and $w_{n_{oc}}(i)$ is given by Table 5.4.2C-2 with n_{oc} provided by higher layers.

The block-wise spread complex-valued symbols shall be transform precoded according to

$$z^{(\tilde{p})}(n \cdot N_{sc}^{RB} + k) = \frac{1}{\sqrt{N_{sc}^{RB}}} \sum_{i=0}^{N_{sc}^{RB}-1} y_n(i) e^{-j \frac{2\pi i k}{N_{sc}^{RB}}}$$

$$k = 0, \dots, N_{sc}^{RB} - 1$$

$$n = 0, \dots, N_0^{PUCCH} + N_1^{PUCCH} - 1$$

where $\tilde{p} = 0$, resulting in a block of complex-valued symbols $z^{(\tilde{p})}(0), \dots, z^{(\tilde{p})}((N_0^{PUCCH} + N_1^{PUCCH})N_{sc}^{RB} - 1)$.

Table 5.4.2C-1: The quantities N_0^{PUCCH} and N_1^{PUCCH}

PUCCH format type	Normal cyclic prefix		Extended cyclic prefix	
	N_0^{PUCCH}	N_1^{PUCCH}	N_0^{PUCCH}	N_1^{PUCCH}
Normal PUCCH format	6	6	5	5
Shortened PUCCH format	6	5	5	4

Table 5.4.2C-2: Orthogonal sequences $w_{n_{oc}}(i)$

n_{oc}	Orthogonal sequences $[w_{n_{CDM}}(0) \dots w_{n_{CDM}}(N_{sc}^{RB} - 1)]$
0	[+1 +1 +1 +1 +1 +1 +1 +1 +1 +1 +1 +1]
1	[+1 +1 +1 +1 +1 +1 -1 -1 -1 -1 -1 -1]

5.4.3 Mapping to physical resources

The block of complex-valued symbols $z^{(\tilde{p})}(i)$ shall be multiplied with the amplitude scaling factor β_{PUCCH} in order to conform to the transmit power P_{PUCCH} specified in Clause 5.1.2.1 in 3GPP TS 36.213 [4], and mapped in sequence starting with $z^{(\tilde{p})}(0)$ to resource elements. PUCCH uses one or more resource block in each of the two slots in a subframe. Within the physical resource block(s) used for transmission, the mapping of $z^{(\tilde{p})}(i)$ to resource elements (k, l) on antenna port p and not used for transmission of reference signals shall be in increasing order of first k , then l and finally the slot number, starting with the first slot in the subframe. The relation between the index \tilde{p} and the antenna port number p is given by Table 5.2.1-1.

For non-BL/CE UEs, except for PUCCH format 4, the physical resource blocks to be used for transmission of PUCCH in slot n_s are given by

$$n_{PRB} = \begin{cases} \left\lfloor \frac{m}{2} \right\rfloor & \text{if } (m + n_s \bmod 2) \bmod 2 = 0 \\ N_{RB}^{UL} - 1 - \left\lfloor \frac{m}{2} \right\rfloor & \text{if } (m + n_s \bmod 2) \bmod 2 = 1 \end{cases}$$

For BL/CE UEs, PUCCH is transmitted with $N_{rep}^{PUCCH} \geq 1$ repetitions. The PUCCH transmission spans

$N_{abs}^{PUCCH} \geq N_{rep}^{PUCCH}$ consecutive subframes, including subframes that are not BL/CE UL subframes where the UE postpones the PUCCH transmission if $N_{rep}^{PUCCH} > 1$.

- The quantity $N_{\text{rep}}^{\text{PUCCH}}$ is given
 - by the higher layer parameter *pucch-NumRepetitionCE-Format1* for PUCCH format 1/1a and *pucch-NumRepetitionCE-Format2* for PUCCH format 2/2a/2b, if configured. Otherwise
 - by the higher-layer parameter *pucch-NumRepetitionCE-Msg4-Level0-r13*, *pucch-NumRepetitionCE-Msg4-Level1-r13*, *pucch-NumRepetitionCE-Msg4-Level2-r13* or *pucch-NumRepetitionCE-Msg4-Level3-r13*.
- If higher layer parameter *resourceReservationDedicatedUL* is configured, then in case of PUCCH transmission with $N_{\text{rep}}^{\text{PUCCH}} > 1$ associated with C-RNTI or SPS C-RNTI using UE-specific MPDCCH search space including PUCCH transmission without a corresponding MPDCCH,
 - In a subframe that is fully reserved as defined in clause 8.0 in [4], the PUCCH transmission is postponed until the next BL/CE uplink subframe that is not fully reserved.
 - In a subframe that is partially reserved, the reserved SC-FDMA symbols shall be counted in the PUCCH mapping but not used for transmission of the PUCCH.

The physical resource blocks to be used for transmission of PUCCH in subframe i within the $N_{\text{abs}}^{\text{PUCCH}}$ consecutive subframes are given by

$$n_{\text{PRB}}(i) = \begin{cases} m'(j)/2 & \text{if } m'(j) \bmod 2 = 0 \\ N_{\text{RB}}^{\text{UL}} - 1 - \lfloor m'(j)/2 \rfloor & \text{if } m'(j) \bmod 2 = 1 \end{cases}$$

$$m'(j) = \begin{cases} m & \text{if } j \bmod 2 = 0 \\ m+1 & \text{if } j \bmod 2 = 1 \text{ and } m \bmod 2 = 0 \\ m-1 & \text{if } j \bmod 2 = 1 \text{ and } m \bmod 2 = 1 \end{cases}$$

$$j = \left\lfloor \frac{i}{N_{\text{ch,UL}}^{\text{NB}}} \right\rfloor$$

$$i_0 \leq i \leq i_0 + N_{\text{abs}}^{\text{PUCCH}} - 1$$

where i_0 is the absolute subframe number of the first uplink subframe intended for PUCCH.

The variable m depends on the PUCCH format.

- Formats 1, 1a and 1b:

$$m = \begin{cases} N_{\text{RB}}^{(2)} & \text{if } n_{\text{PUCCH}}^{(1,\tilde{p})} < c \cdot N_{\text{cs}}^{(1)} / \Delta_{\text{shift}}^{\text{PUCCH}} \\ \left\lfloor \frac{n_{\text{PUCCH}}^{(1,\tilde{p})} - c \cdot N_{\text{cs}}^{(1)} / \Delta_{\text{shift}}^{\text{PUCCH}}}{c \cdot N_{\text{sc}}^{\text{RB}} / \Delta_{\text{shift}}^{\text{PUCCH}}} \right\rfloor + N_{\text{RB}}^{(2)} + \left\lfloor \frac{N_{\text{cs}}^{(1)}}{8} \right\rfloor & \text{otherwise} \end{cases}$$

$$c = \begin{cases} 3 & \text{normal cyclic prefix} \\ 2 & \text{extended cyclic prefix} \end{cases}$$

- Formats 2, 2a and 2b:

$$m = \left\lfloor n_{\text{PUCCH}}^{(2,\tilde{p})} / N_{\text{sc}}^{\text{RB}} \right\rfloor$$

- Format 3:

$$m = \left\lfloor n_{\text{PUCCH}}^{(3,\tilde{p})} / N_{\text{SF},0}^{\text{PUCCH}} \right\rfloor$$

- Format 5 (non-BL/CE UEs only):

$$m = n_{\text{PUCCH}}^{(5)}$$

For non-BL/CE UEs, for PUCCH format 4, the physical resource blocks to be used for transmission of PUCCH in slot n_s are given by

$$n_{\text{PRB}} = \begin{cases} m & \text{if } n_s \bmod 2 = 0 \\ N_{\text{RB}}^{\text{UL}} - 1 - m & \text{if } n_s \bmod 2 = 1 \end{cases}$$

$$m = n_{\text{PUCCH}}^{(4)}, n_{\text{PUCCH}}^{(4)} + 1, \dots, n_{\text{PUCCH}}^{(4)} + M_{\text{RB}}^{\text{PUCCH4}} - 1$$

where $M_{\text{RB}}^{\text{PUCCH4}}$ is obtained from [4].

Mapping of modulation symbols for the physical uplink control channel for PUCCH formats 1 – 3 is illustrated in Figure 5.4.3-1.

In case of simultaneous transmission of sounding reference signal and PUCCH format 1, 1a, 1b, 3, 4 or 5 when there is one serving cell configured, the shortened PUCCH format shall be used where the last SC-FDMA symbol in the second slot of a subframe shall be left empty.

In case of guard period for narrowband or wideband retuning for BL/CE UEs, if an SC-FDMA symbol is left empty due to guard period, the SC-FDMA symbol shall be counted in the PUCCH mapping but not used for transmission of the PUCCH. The SC-FDMA symbol affected by the guard period can be the first SC-FDMA symbol in the first slot of a subframe and/or the last SC-FDMA symbol in the second slot of a subframe.

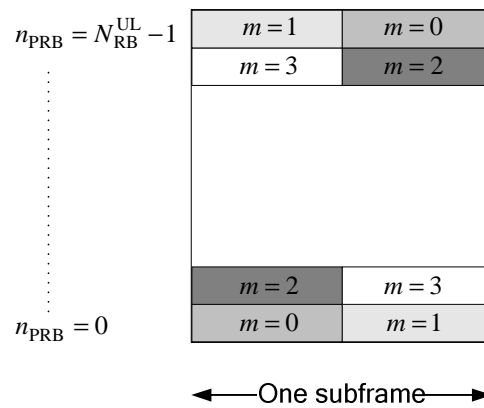

Figure 5.4.3-1: Mapping to physical resource blocks for PUCCH formats 1 – 3 for non-BL/CE UEs.

5.4A Short Physical Uplink Control Channel

5.4A.1 General

The short physical uplink control channel, SPUCCH, carries uplink control information. Simultaneous transmission of SPUCCH and PUSCH from the same UE where both SPUCCH and PUSCH is using either slot or subslot transmission is supported if enabled by higher layers (see *simultaneousPUCCH-PUSCH* in 3GPP TS 36.331 [9]). For frame structure type 2 and in UpPTS, transmission of SPUCCH is not supported.

SPUCCH supports multiple formats as shown in Table 5.4A-1 and Table 5.4A-2 with different number of bits carried by each SPUCCH.

Table 5.4A-1: SPUCCH formats for slot transmission

SPUCCH format	Modulation scheme	Number of bits per slot, M_{bit}
1	N/A	N/A
1a	BPSK	1
1b	QPSK	2
3	QPSK	24
4	QPSK	$M_{\text{RB}}^{\text{SPUCCH4}} \cdot N_{\text{sc}}^{\text{RB}} \cdot N_{\text{slot}}^{\text{SPUCCH}} \cdot 2$

Table 5.4A-2: SPUCCH formats for subslot transmission

SPUCCH format	Modulation scheme	Number of bits per subslot, M_{bit}
1	N/A	N/A
1a	N/A	1
1b	N/A	2
4	QPSK	$M_{\text{RB}}^{\text{SPUCCH4}} \cdot N_{\text{sc}}^{\text{RB}} \cdot N_{\text{subslot}}^{\text{SPUCCH}} \cdot 2$

The quantity $M_{\text{RB}}^{\text{SPUCCH4}}$ represents the bandwidth of the SPUCCH format 4 as defined by clause 5.4A.4.1, and $N_{\text{slot}}^{\text{SPUCCH}}$ and $N_{\text{subslot}}^{\text{SPUCCH}}$ are defined in Table 5.4A.4.1-1 and Table 5.4A.4.2-1, respectively.

SPUCCH formats 1/1a/1b use a cyclic shift, $n_{\text{cs}}^{\text{cell}}(n_s, l)$, which varies with the symbol number l and the slot number n_s as described in clause 5.4.

5.4A.2 SPUCCH formats 1, 1a, 1b

5.4A.2.1 Slot-SPUCCH

Slot-SPUCCH format 1, 1a, 1b can be configured by higher layers to either have frequency hopping enabled or disabled (see *n1SlotSPUCCH-FH-AN-List* and *n1SlotSPUCCH-NoFH-AN-List* in 3GPP TS 36.331 [9]).

In case slot-SPUCCH format 1, 1a, 1b and frequency hopping is enabled, the scrambled and block-wise spread complex-valued symbols $z^{(\tilde{p})}$ are generated as described in clause 5.4.1 for PUCCH format 1/1a/1b where $S(n_s) = 1$, $m' = 0$ and $w(m) = +1$.

In case slot-SPUCCH format 1, 1a, 1b and frequency hopping is disabled, the scrambled and block-wise spread complex-valued symbols $z^{(\tilde{p})}$ are generated as described in clause 5.4.1 for PUCCH format 1/1a/1b where $m' = 0$.

Irrespective of frequency hopping being enabled or disabled, $N_{\text{SF}}^{\text{PUCCH}}$ is applied as described in clause 5.4.1 for the slot in which the slot-SPUCCH is transmitted in, i.e. either in the first or the second slot of the subframe.

Resources used for transmission of slot-SPUCCH format 1, 1a and 1b are identified by a resource index $n_{\text{SPUCCH}}^{(1, \tilde{p})}$ from which the cyclic shift $\alpha_{\tilde{p}}(n_s, l)$ is derived:

$$\alpha_{\tilde{p}}(n_s, l) = 2\pi \cdot n_{cs}^{(\tilde{p})}(n_s, l) / N_{sc}^{RB},$$

In case frequency hopping is enabled, the cyclic shift is determined as described in clause 5.4.2, assuming the condition $n_{PUCCH}^{(2, \tilde{p})} < N_{sc}^{RB} N_{RB}^{(2)}$ is fulfilled.

In case frequency hopping is disabled, the resource index $n_{SPUCCH}^{(1, \tilde{p})}$ also indicates the orthogonal sequence index $n_{oc}^{(\tilde{p})}(n_s)$. Both the cyclic shift and the orthogonal sequence index is in this case determined as described in clause 5.4.1.

5.4A.2.2 Subslot-SPUCCH

For subslot-SPUCCH formats 1a and 1b, one or two bits are communicated by SPUCCH resource selection. The resource set available for selection are configured by higher layers (see *n1SubslotSPUCCH-AN-List* and *sr-SubslotSPUCCH-ResourceList* in 3GPP TS 36.331 [9]). For subslot-SPUCCH format 1, information is carried by the presence/absence of transmission of subslot-SPUCCH from the UE.

The sequence $y^{(\tilde{p}, \delta)}(n)$ is generated as described in clause 5.4.1, assuming $d(0) = 1$.

The block of complex-valued symbols $y^{(\tilde{p})}(0), \dots, y^{(\tilde{p})}(N_{seq}^{PUCCH} - 1)$ shall be scrambled by $S(n_s) = 1$ as described in clause 5.4.1 assuming $w_{n_{oc}^{(\tilde{p})}}(i) = 1$, $m' = 0$, and with N_{SF}^{PUCCH} replaced by N_{SF}^{SPUCCH} , defined in Table 5.4A.2.2-1.

Table 5.4A.2.2-1: The quantity N_{SF}^{SPUCCH} for subslot-SPUCCH formats 1a and 1b

SPUCCH format type	Subslot number in subframe	N_{SF}^{SPUCCH}
Normal SPUCCH format	1,2,3,4	2
Normal SPUCCH format	0,5	3
Shortened SPUCCH format	5	2

Resources used for transmission of SPUCCH format 1, 1a and 1b are identified by a resource index $n_{SPUCCH,i}^{(1, \tilde{p})}$ from which the cyclic shift $\alpha_{\tilde{p}}(n_s, l)$ is determined, as described in clause 5.4.2, assuming the condition $n_{PUCCH}^{(2, \tilde{p})} < N_{sc}^{RB} N_{RB}^{(2)}$ is fulfilled. The resource set for subslot-SPUCCH format 1/1a/1b is configured by higher layers (see *n1SubslotSPUCCH-AN-List* in 3GPP TS 36.331 [9]):

- subslot-SPUCCH format 1: $n_{SPUCCH,i}^{(1, \tilde{p})}, i \in \{0\}$
- subslot-SPUCCH format 1a: $n_{SPUCCH,i}^{(1, \tilde{p})}, i \in \{0,1\}$
- subslot-SPUCCH format 1b: $n_{SPUCCH,i}^{(1, \tilde{p})}, i \in \{0,1,2,3\}$

Each resource indicates (a) bit state(s) as defined by Table 5.4A.2.2-2.

Table 5.4A.2.2-2: Subslot-SPUCCH resource for formats 1a and 1b

PUCCH format	$b(0), \dots, b(M_{\text{bit}} - 1)$	$n_{\text{SPUCCH},i}^{(1,\tilde{p})}$
1	-	$n_{\text{SPUCCH},0}^{(1,\tilde{p})}$
1a	0	$n_{\text{SPUCCH},0}^{(1,\tilde{p})}$
	1	$n_{\text{SPUCCH},1}^{(1,\tilde{p})}$
1b	00	$n_{\text{SPUCCH},0}^{(1,\tilde{p})}$
	10	$n_{\text{SPUCCH},1}^{(1,\tilde{p})}$
	01	$n_{\text{SPUCCH},2}^{(1,\tilde{p})}$
	11	$n_{\text{SPUCCH},3}^{(1,\tilde{p})}$

5.4A.3 SPUCCH format 3

5.4A.3.1 Slot-SPUCCH

The complex-valued modulation symbols $d(0), \dots, d(M_{\text{symb}} - 1)$ shall be generated as described in clause 5.4.2A.

Depending on if the slot-SPUCCH is transmitted in the first or the second slot of the subframe, different block-wise spreading with the orthogonal sequences $w_{n_{\text{oc},0}}^{(\tilde{p})}(i)$ or $w_{n_{\text{oc},1}}^{(\tilde{p})}(i)$ is applied. Each spreading results in $N_{\text{SF}}^{\text{SPUCCH}}$ sets of $N_{\text{sc}}^{\text{RB}}$ values each according to:

$$y_n^{(\tilde{p})}(i) = \begin{cases} w_{n_{\text{oc},0}}^{(\tilde{p})}(n) \cdot e^{j\pi \lfloor n_{\text{cs}}^{\text{cell}}(n_s, l) / 64 \rfloor / 2} \cdot d(i) & \text{if } n_s \bmod 2 = 0 \\ w_{n_{\text{oc},1}}^{(\tilde{p})}(n) \cdot e^{j\pi \lfloor n_{\text{cs}}^{\text{cell}}(n_s, l) / 64 \rfloor / 2} \cdot d(i) & \text{otherwise} \end{cases}$$

$$n = 0, \dots, N_{\text{SF}}^{\text{SPUCCH}} - 1$$

$$i = 0, 1, \dots, N_{\text{sc}}^{\text{RB}} - 1$$

where

- $N_{\text{SF}}^{\text{SPUCCH}} = N_{\text{SF},0}^{\text{PUCCH}}$ (see clause 5.4.2A) if transmitted in the first slot, and $N_{\text{SF}}^{\text{SPUCCH}} = N_{\text{SF},1}^{\text{PUCCH}}$ (see clause 5.4.2A), if transmitted in the second slot.
- The orthogonal sequences $w_{n_{\text{oc},0}}^{(\tilde{p})}(i)$ and $w_{n_{\text{oc},1}}^{(\tilde{p})}(i)$ are given by Table 5.4.2A-1

Resources used for transmission of SPUCCH format 3 are identified by a resource index $n_{\text{SPUCCH}}^{(3,\tilde{p})}$ from which the quantities $n_{\text{oc},0}^{(\tilde{p})}$ and $n_{\text{oc},1}^{(\tilde{p})}$ are derived according to clause 5.4A.3 by replacing $n_{\text{PUCCH}}^{(3,\tilde{p})}$ with $n_{\text{SPUCCH}}^{(3,\tilde{p})}$.

Each set of complex-valued symbols shall be cyclically shifted and transform precoded according to clause 5.4.2A with $N_{\text{SF},0}^{\text{PUCCH}} + N_{\text{SF},1}^{\text{PUCCH}}$ replaced by $N_{\text{SF}}^{\text{SPUCCH}}$ in the transform precoding.

5.4A.4 SPUCCH format 4

5.4A.4.1 Slot-SPUCCH

The block of bits $b(0), \dots, b(M_{\text{bit}} - 1)$ shall be scrambled according to clause 5.4.2B.

The block of scrambled bits $\tilde{b}(0), \dots, \tilde{b}(M_{\text{bit}} - 1)$ shall be QPSK modulated as described in Clause 7.1, resulting in a block of complex-valued modulation symbols $d(0), \dots, d(M_{\text{symb}} - 1)$ where $M_{\text{symb}} = M_{\text{bit}}/2$.

The block of complex-valued symbols $d(0), \dots, d(M_{\text{symb}} - 1)$ is divided into $N_{\text{slot}}^{\text{SPUCCH}}$ (defined in Table 5.4A.4.1-1) sets, each corresponding to one SC-FDMA symbol. Transform precoding shall be applied according to clause 5.4.2B replacing $M_{\text{sc}}^{\text{PUCCH4}}$ with $M_{\text{sc}}^{\text{SPUCCH4}}$ and replacing $N_0^{\text{PUCCH}} + N_1^{\text{PUCCH}}$ with $N_{\text{slot}}^{\text{SPUCCH}}$.

The variable $M_{\text{sc}}^{\text{SPUCCH4}} = M_{\text{RB}}^{\text{SPUCCH4}} \cdot N_{\text{sc}}^{\text{RB}}$, where $M_{\text{RB}}^{\text{SPUCCH4}}$ represents the bandwidth of the SPUCCH format 4 in terms of resource blocks in the frequency domain, and is determined by higher layer signalling (*n4numberOfPRB-r15*, see 3GPP TS 36.213 [4, Table 10.1.1-2] and 3GPP TS 36.331 [9]), and shall fulfil

$$M_{\text{RB}}^{\text{SPUCCH4}} = 2^{\alpha_2} \cdot 3^{\alpha_3} \cdot 5^{\alpha_5} \leq N_{\text{RB}}^{\text{UL}},$$

where, $\alpha_2, \alpha_3, \alpha_5$ is a set of non-negative integers.

Table 5.4A.4.1-1: The quantity $N_{\text{slot}}^{\text{SPUCCH}}$.

SPUCCH format type	$N_{\text{slot}}^{\text{SPUCCH}}$
Normal SPUCCH format	5
Shortened SPUCCH format	4

5.4A.4.2 Subslot-SPUCCH

For subslot-SPUCCH the procedure of slot-SPUCCH in clause 5.4A.4.1 is followed except that:

- the block of complex-valued symbols $d(0), \dots, d(M_{\text{symb}} - 1)$ is divided into $N_{\text{subslot}}^{\text{SPUCCH}}$ (defined in Table 5.4A.4.2-1) sets, instead of $N_{\text{slot}}^{\text{SPUCCH}}$ sets, and,
- $N_{\text{slot}}^{\text{SPUCCH}}$ is replaced by $N_{\text{subslot}}^{\text{SPUCCH}}$, in the transform precoding.

Table 5.4A.4.2-1: The quantity $N_{\text{subslot}}^{\text{SPUCCH}}$.

SPUCCH format type	Subslot number in subframe	$N_{\text{subslot}}^{\text{SPUCCH}}$
Normal SPUCCH format	1,2,3,4	1
Normal SPUCCH format	0,5	2
Shortened SPUCCH format	5	1

5.4A.5 Mapping to physical resources

The block of complex-valued symbols $z^{(\tilde{p})}(i)$ shall be multiplied with the amplitude scaling factor β_{SPUCCH} in order to conform to the transmit power P_{SPUCCH} specified in Clause 5.1.2.1 of 3GPP TS 36.213 [4], and mapped in sequence starting with $z^{(\tilde{p})}(0)$ to resource elements.

SPUCCH uses one or more resource block in the frequency domain and is mapped to either a slot or a subslot in the time domain. Within the physical resource block(s) used for transmission, the mapping of $z^{(\tilde{p})}(i)$ to resource elements (k, l) on antenna port p and not used for transmission of reference signals shall be in increasing order of first k , then l .

The starting symbol l for each subslot number is provided by Table 5.4A.4.5-1 for subslot-SPUCCH.

For slot-SPUCCH the starting symbol is $l = 0$ for the slot the SPUCCH is transmitted in.

Table 5.4A.5-1: Starting symbol for subslot-SPUCCH mapping

	Subslot number					
	0	1	2	3	4	5
Format 1/1a/1b	0	3	5	0	2	4
Format 4	1	4	6	1	3	5

The relation between the index \tilde{p} and the antenna port number p is given by Table 5.2.1-1.

The physical resource blocks (n_{PRB}) within which the transmission of SPUCCH is carried out in slot n_s depends on the SPUCCH format and whether frequency hopping is enabled or not.

In case of slot-SPUCCH format 1, 1a, 1b and frequency hopping disabled, the PRB used is determined as described in clause 5.4.3 for PUCCH format 1, 1a, 1b.

In case of slot-SPUCCH format 3, the PRB used is given by

$$n_{\text{PRB}} = \begin{cases} \left\lfloor \frac{m}{2} \right\rfloor & \text{if } (m + n_s \bmod 2) \bmod 2 = 0 \\ N_{\text{RB}}^{\text{UL}} - 1 - \left\lfloor \frac{m}{2} \right\rfloor & \text{if } (m + n_s \bmod 2) \bmod 2 = 1 \end{cases}$$

For the other SPUCCH formats, it is determined by Table 5.4A.5-2, Table 5.4A.5-3 and Table 5.4A.5-4.

Table 5.4A.5-2: n_{PRB} for slot-SPUCCH format 1, 1a, 1b with frequency hopping enabled

Slot number	Slot-SPUCCH format
	Format 1/1a/1b with frequency hopping enabled
$n_s \bmod 2 = 0$	$\left\lfloor \frac{m}{2} \right\rfloor \quad \text{for } l = 0, 1 \text{ or } 2$ $N_{RB}^{UL} - 1 - \left\lfloor \frac{m}{2} \right\rfloor \quad \text{for } l = 3, 4, 5 \text{ or } 6$ <p style="text-align: center;">for $(m + n_s \bmod 2) \bmod 2 = 0$</p> $N_{RB}^{UL} - 1 - \left\lfloor \frac{m}{2} \right\rfloor \quad \text{for } l = 0, 1 \text{ or } 2$ $\left\lfloor \frac{m}{2} \right\rfloor \quad \text{for } l = 3, 4, 5 \text{ or } 6$ <p style="text-align: center;">for $(m + n_s \bmod 2) \bmod 2 = 1$</p>
$n_s \bmod 2 = 1$	$\left\lfloor \frac{m}{2} \right\rfloor \quad \text{for } l = 0, 1, 2 \text{ or } 3$ $N_{RB}^{UL} - 1 - \left\lfloor \frac{m}{2} \right\rfloor \quad \text{for } l = 4, 5 \text{ or } 6$ <p style="text-align: center;">for $(m + n_s \bmod 2) \bmod 2 = 0$</p> $N_{RB}^{UL} - 1 - \left\lfloor \frac{m}{2} \right\rfloor \quad \text{for } l = 0, 1, 2 \text{ or } 3$ $\left\lfloor \frac{m}{2} \right\rfloor \quad \text{for } l = 4, 5 \text{ or } 6$ <p style="text-align: center;">for $(m + n_s \bmod 2) \bmod 2 = 1$</p>

Table 5.4A.5-3: n_{PRB} for slot-SPUCCH format 4

Slot number	Slot-SPUCCH format
	Format 4
$n_s \bmod 2 = 0$	$m \quad \text{for } l = 0, 1 \text{ or } 2$ $N_{RB}^{UL} - 1 - m \quad \text{for } l = 3, 4, 5 \text{ or } 6$
$n_s \bmod 2 = 1$	$m \quad \text{for } l = 4, 5 \text{ or } 6$ $N_{RB}^{UL} - 1 - m \quad \text{for } l = 0, 1, 2 \text{ or } 3$

Table 5.4A.5-4: n_{PRB} for subslot-SPUCCH format 1, 1a, 1b, 4

Subslot number	SPUCCH format	
	Format 1/1a/1b	Format 4
0	$\left\lfloor \frac{m}{2} \right\rfloor$ for $l = 0$ $N_{RB}^{UL} - 1 - \left\lfloor \frac{m}{2} \right\rfloor$ for $l = 1, 2$ $N_{RB}^{UL} - 1 - \left\lfloor \frac{m}{2} \right\rfloor$ for $l = 0$ $\left\lfloor \frac{m}{2} \right\rfloor$ for $l = 1, 2$	m for $l = 1, 2$
1	$\left\lfloor \frac{m}{2} \right\rfloor$ for $l = 4$ $N_{RB}^{UL} - 1 - \left\lfloor \frac{m}{2} \right\rfloor$ for $l = 3$ $N_{RB}^{UL} - 1 - \left\lfloor \frac{m}{2} \right\rfloor$ for $l = 4$ $\left\lfloor \frac{m}{2} \right\rfloor$ for $l = 3$	m for $l = 4$
2	$\left\lfloor \frac{m}{2} \right\rfloor$ for $l = 5$ $N_{RB}^{UL} - 1 - \left\lfloor \frac{m}{2} \right\rfloor$ for $l = 6$ $N_{RB}^{UL} - 1 - \left\lfloor \frac{m}{2} \right\rfloor$ for $l = 5$ $\left\lfloor \frac{m}{2} \right\rfloor$ for $l = 6$	m for $l = 6$
3	$\left\lfloor \frac{m}{2} \right\rfloor$ for $l = 1$ $N_{RB}^{UL} - 1 - \left\lfloor \frac{m}{2} \right\rfloor$ for $l = 0$ $N_{RB}^{UL} - 1 - \left\lfloor \frac{m}{2} \right\rfloor$ for $l = 1$ $\left\lfloor \frac{m}{2} \right\rfloor$ for $l = 0$	m for $l = 1$
4	$\left\lfloor \frac{m}{2} \right\rfloor$ for $l = 2$ $N_{RB}^{UL} - 1 - \left\lfloor \frac{m}{2} \right\rfloor$ for $l = 3$ $N_{RB}^{UL} - 1 - \left\lfloor \frac{m}{2} \right\rfloor$ for $l = 2$ $\left\lfloor \frac{m}{2} \right\rfloor$ for $l = 3$	m for $l = 3$

5	$\begin{aligned} & \left\lfloor \frac{m}{2} \right\rfloor && \text{for } l = 5,6 && \text{for } (m + n_s \bmod 2) \bmod 2 = 0 \\ N_{RB}^{UL} - 1 - & \left\lfloor \frac{m}{2} \right\rfloor && \text{for } l = 4 \end{aligned}$ $\begin{aligned} & \left\lfloor \frac{m}{2} \right\rfloor && \text{for } l = 5,6 && \text{for } (m + n_s \bmod 2) \bmod 2 = 1 \\ N_{RB}^{UL} - 1 - & \left\lfloor \frac{m}{2} \right\rfloor && \text{for } l = 4 \end{aligned}$	m for $l = 5,6$
---	--	-------------------

The variable m depends on the SPUCCH format as defined in Table 5.4A.5-5.

Table 5.4A.5-5: m for SPUCCH

SPUCCH Format		m
Slot	Format 1, 1a, 1b	Frequency hopping disabled: see derivation of m for PUCCH format 1, 1a, 1b in clause 5.4.3 replacing $n_{PUCCH}^{(1,\tilde{p})}$ with $n_{SPUCCH}^{(1,\tilde{p})}$ Frequency hopping enabled: see derivation of m for PUCCH format 2, 2a, 2b in clause 5.4.3 replacing $n_{PUCCH}^{(2,\tilde{p})}$ with $n_{SPUCCH}^{(1,\tilde{p})}$
	Format 3	$\left\lfloor \frac{n_{SPUCCH}^{(3,\tilde{p})}}{N_{SF,0}^{PUCCH}} \right\rfloor$
	Format 4	$m = n_{SPUCCH}^{(4)}, n_{SPUCCH}^{(4)} + 1, \dots, n_{SPUCCH}^{(4)} + M_{RB}^{SPUCCH4} - 1$
Subslot	Format 1, 1a, 1b	see derivation of m for PUCCH format 2, 2a, 2b in clause 5.4.3 replacing $n_{PUCCH}^{(2,\tilde{p})}$ with $n_{SPUCCHi}^{(1,\tilde{p})}$
	Format 4	$m = n_{SPUCCH}^{(4)}, n_{SPUCCH}^{(4)} + 1, \dots, n_{SPUCCH}^{(4)} + M_{RB}^{SPUCCH4} - 1$

In case of subslot-SPUCCH, there is a configuration restriction that each SPUCCH resource in the resource set, of up to four resources, $n_{SPUCCHi}^{(1,\tilde{p})}, i \in \{0,1,2,3\}$, shall map to the same pair of PRBs (n_{PRB}) This restriction applies separately to each of $nI_{SubslotSPUCCH-AN-List}$ and $sr_{SubslotSPUCCH-Resource}$ in 3GPP TS 36.331 [9].

In case of simultaneous transmission of sounding reference signal and SPUCCH when there is one serving cell configured, the shortened SPUCCH format shall be used where the last SC-FDMA symbol in the second slot of a subframe shall be left empty.

5.5 Reference signals

Two types of uplink reference signals are supported:

- Demodulation reference signal, associated with transmission of PUSCH or (S)PUCCH
- Sounding reference signal, not associated with transmission of PUSCH or (S)PUCCH

The same set of base sequences is used for demodulation and sounding reference signals.

5.5.1 Generation of the reference signal sequence

Reference signal sequence $r_{u,v}^{(\alpha,\delta)}(n)$ is defined by a cyclic shift α of a base sequence $\bar{r}_{u,v}(n)$ according to

$$r_{u,v}^{(\alpha,\delta)}(n) = e^{j\alpha\left(\frac{n+\delta \bmod 2}{2}\right)} \bar{r}_{u,v}(n), \quad 0 \leq n < M_{sc}^{RS}$$

where

- $M_{sc}^{RS} = mN_{sc}^{RB} / 2^\delta$ is the length of the reference signal sequence, $1 \leq m \leq N_{RB}^{\max,UL}$, δ is defined in clause 5.5.2.1.2, and,
- $\delta = 1$ when either
 - the higher-layer parameter *ul-DMRS-IFDMA* is set and the most recent uplink-related DCI contains the *Cyclic Shift Field mapping table for DMRS bit* field which is set to 1 to indicate the use of Table 5.5.2.1.1-3, or,
 - the *Cyclic Shift Field mapping table for DMRS bit* is set to 1 in the most recent uplink-related DCI format 7 which indicates the use of Table 5.5.2.1.1-4, and
- $\delta = 0$ otherwise.

Multiple reference signal sequences are defined from a single base sequence through different values of α .

Base sequences $\bar{r}_{u,v}(n)$ are divided into groups, where $u \in \{0,1,\dots,29\}$ is the group number and v is the base sequence number within the group, such that each group contains one base sequence ($v = 0$) of each length $M_{sc}^{RS} = mN_{sc}^{RB}$, $1 \leq m \leq 5$ and two base sequences ($v = 0,1$) of each length $M_{sc}^{RS} = mN_{sc}^{RB}$, $6 \leq m \leq N_{RB}^{\max,UL}$. The sequence group number u and the number v within the group may vary in time as described in clauses 5.5.1.3 and 5.5.1.4, respectively. The definition of the base sequence $\bar{r}_{u,v}(0), \dots, \bar{r}_{u,v}(M_{sc}^{RS} - 1)$ depends on the sequence length M_{sc}^{RS} .

5.5.1.1 Base sequences of length $3N_{sc}^{RB}$ or larger

For $M_{sc}^{RS} \geq 3N_{sc}^{RB}$, the base sequence $\bar{r}_{u,v}(0), \dots, \bar{r}_{u,v}(M_{sc}^{RS} - 1)$ is given by

$$\bar{r}_{u,v}(n) = x_q(n \bmod N_{ZC}^{RS}), \quad 0 \leq n < M_{sc}^{RS}$$

where the q^{th} root Zadoff-Chu sequence is defined by

$$x_q(m) = e^{-j \frac{\pi q m(m+1)}{N_{ZC}^{RS}}}, \quad 0 \leq m \leq N_{ZC}^{RS} - 1$$

with q given by

$$q = \lfloor \bar{q} + 1/2 \rfloor + v \cdot (-1)^{\lfloor 2\bar{q} \rfloor}$$

$$\bar{q} = N_{ZC}^{RS} \cdot (u+1) / 31$$

The length N_{ZC}^{RS} of the Zadoff-Chu sequence is given by the largest prime number such that $N_{ZC}^{RS} < M_{sc}^{RS}$.

5.5.1.2 Base sequences of length less than $3N_{sc}^{RB}$

For $M_{sc}^{RS} = N_{sc}^{RB}$, $M_{sc}^{RS} = 2N_{sc}^{RB}$, $M_{sc}^{RS} = N_{sc}^{RB}/2$, and $M_{sc}^{RS} = 3N_{sc}^{RB}/2$, the base sequence is given by

$$\bar{r}_{u,v}(n) = e^{j\varphi(n)\pi/4}, \quad 0 \leq n \leq M_{sc}^{RS} - 1$$

where the value of $\varphi(n)$ is given by Table 5.5.1.2-1, Table 5.5.1.2-2, Table 5.5.1.2-3, and Table 5.5.1.2-4 for $M_{sc}^{RS} = N_{sc}^{RB}$, $M_{sc}^{RS} = 2N_{sc}^{RB}$, $M_{sc}^{RS} = N_{sc}^{RB}/2$, and $M_{sc}^{RS} = 3N_{sc}^{RB}/2$, respectively. For $M_{sc}^{RS} = 5N_{sc}^{RB}/2$, the base sequence $\bar{r}_{u,v}(0), \dots, \bar{r}_{u,v}(M_{sc}^{RS} - 1)$ is given by

$$\bar{r}_{u,v}(n) = e^{-j\frac{\pi(u+1)(n+1)(n+2)}{31}}, \quad 0 \leq n \leq M_{sc}^{RS} - 1$$

Table 5.5.1.2-1: Definition of $\varphi(n)$ for $M_{sc}^{RS} = N_{sc}^{RB}$.

u	$\varphi(0), \dots, \varphi(11)$											
0	-1	1	3	-3	3	3	1	1	3	1	-3	3
1	1	1	3	3	3	-1	1	-3	-3	1	-3	3
2	1	1	-3	-3	-3	-1	-3	-3	1	-3	1	-1
3	-1	1	1	1	1	-1	-3	-3	1	-3	3	-1
4	-1	3	1	-1	1	-1	-3	-1	1	-1	1	3
5	1	-3	3	-1	-1	1	1	-1	-1	3	-3	1
6	-1	3	-3	-3	-3	3	1	-1	3	3	-3	1
7	-3	-1	-1	-1	1	-3	3	-1	1	-3	3	1
8	1	-3	3	1	-1	-1	-1	1	1	3	-1	1
9	1	-3	-1	3	3	-1	-3	1	1	1	1	1
10	-1	3	-1	1	1	-3	-3	-1	-3	-3	3	-1
11	3	1	-1	-1	3	3	-3	1	3	1	3	3
12	1	-3	1	1	-3	1	1	1	-3	-3	-3	1
13	3	3	-3	3	-3	1	1	3	-1	-3	3	3
14	-3	1	-1	-3	-1	3	1	3	3	3	-1	1
15	3	-1	1	-3	-1	-1	1	1	3	1	-1	-3
16	1	3	1	-1	1	3	3	3	-1	-1	3	-1
17	-3	1	1	3	-3	3	-3	-3	3	1	3	-1
18	-3	3	1	1	-3	1	-3	-3	-1	-1	1	-3
19	-1	3	1	3	1	-1	-1	3	-3	-1	-3	-1
20	-1	-3	1	1	1	1	3	1	-1	1	-3	-1
21	-1	3	-1	1	-3	-3	-3	-3	-3	1	-1	-3
22	1	1	-3	-3	-3	-3	-1	3	-3	1	-3	3
23	1	1	-1	-3	-1	-3	1	-1	1	3	-1	1
24	1	1	3	1	3	3	-1	1	-1	-3	-3	1
25	1	-3	3	3	1	3	3	1	-3	-1	-1	3
26	1	3	-3	-3	3	-3	1	-1	-1	3	-1	-3
27	-3	-1	-3	-1	-3	3	1	-1	1	3	-3	-3
28	-1	3	-3	3	-1	3	3	-3	3	3	-1	-1
29	3	-3	-3	-1	-1	-3	-1	3	-3	3	1	-1

Table 5.5.1.2-2: Definition of $\varphi(n)$ for $M_{sc}^{RS} = 2N_{sc}^{RB}$

u	$\varphi(0), \dots, \varphi(23)$																							
0	-1	3	1	-3	3	-1	1	3	-3	3	1	3	-3	3	1	1	-1	1	3	-3	3	-3	-1	-3
1	-3	3	-3	-3	-3	1	-3	-3	3	-1	1	1	1	3	1	-1	3	-3	-3	1	3	1	1	-3
2	3	-1	3	3	1	1	-3	3	3	3	3	1	-1	3	-1	1	1	-1	-3	-1	-1	1	3	3
3	-1	-3	1	1	3	-3	1	1	-3	-1	-1	1	3	1	3	1	-1	3	1	1	-3	-1	-3	-1
4	-1	-1	-1	-3	-3	-1	1	1	3	3	-1	3	-1	1	-1	-3	1	-1	-3	-3	1	-3	-1	-1
5	-3	1	1	3	-1	1	3	1	-3	1	-3	1	1	-1	-1	3	-1	-3	3	-3	-3	-3	1	1
6	1	1	-1	-1	3	-3	-3	3	-3	1	-1	-1	1	-1	1	1	-1	-3	-1	1	-1	3	-1	-3
7	-3	3	3	-1	-1	-3	-1	3	1	3	1	3	1	1	-1	3	1	-1	1	3	-3	-1	-1	1
8	-3	1	3	-3	1	-1	-3	3	-3	3	-1	-1	-1	-1	1	-3	-3	-3	1	-3	-3	-3	1	-3
9	1	1	-3	3	3	-1	-3	-1	3	-3	3	3	3	-1	1	1	-3	1	-1	1	1	-3	1	1
10	-1	1	-3	-3	3	-1	3	-1	-1	-3	-3	-3	-1	-3	-3	1	-1	1	3	3	-1	1	-1	3
11	1	3	3	-3	-3	1	3	1	-1	-3	-3	-3	3	3	-3	3	3	-1	-3	3	-1	1	-3	1
12	1	3	3	1	1	1	-1	-1	1	-3	3	-1	1	1	-3	3	3	-1	-3	3	-3	-1	-3	-1
13	3	-1	-1	-1	-1	-3	-1	3	3	1	-1	1	3	3	3	-1	1	1	-3	1	3	-1	-3	3
14	-3	-3	3	1	3	1	-3	3	1	3	1	1	3	3	-1	-1	-3	1	-3	-1	3	1	1	3
15	-1	-1	1	-3	1	3	-3	1	-1	-3	-1	3	1	3	1	-1	-3	-3	-1	-1	-3	-3	-3	-1
16	-1	-3	3	-1	-1	-1	-1	1	1	-3	3	1	3	3	1	-1	1	-3	1	-3	1	1	-3	-1
17	1	3	-1	3	3	-1	-3	1	-1	-3	3	3	3	-1	1	1	3	-1	-3	-1	3	-1	-1	-1
18	1	1	1	1	1	-1	3	-1	-3	1	1	3	-3	1	-3	-1	1	1	-3	-3	3	1	1	-3
19	1	3	3	1	-1	-3	3	-1	3	3	3	-3	1	-1	1	-1	-3	-1	1	3	-1	3	-3	-3
20	-1	-3	3	-3	-3	-3	-1	-1	-3	-1	-3	3	1	3	-3	-1	3	-1	1	-1	3	-3	1	-1
21	-3	-3	1	1	-1	1	-1	1	-1	3	1	-3	-1	1	-1	1	-1	-1	3	3	-3	-1	1	-3
22	-3	-1	-3	3	1	-1	-3	-1	-3	-3	3	-3	3	-3	-1	1	3	1	-3	1	3	3	-1	-3
23	-1	-1	-1	-1	3	3	3	1	3	3	-3	1	3	-1	3	-1	3	3	-3	3	1	-1	3	3
24	1	-1	3	3	-1	-3	3	-3	-1	-1	3	-1	3	-1	-1	1	1	1	1	-1	-1	-3	-1	3
25	1	-1	1	-1	3	-1	3	1	1	-1	-1	-3	1	1	-3	1	3	-3	1	1	-3	-3	-1	-1
26	-3	-1	1	3	1	1	-3	-1	-1	-3	3	-3	3	1	-3	3	-3	1	-1	1	-3	1	1	1
27	-1	-3	3	3	1	1	3	-1	-3	-1	-1	-1	3	1	-3	-3	-1	3	-3	-1	-3	-1	-3	-1
28	-1	-3	-1	-1	1	-3	-1	-1	1	-1	-3	1	1	-3	1	-3	-3	3	1	1	-1	3	-1	-1
29	1	1	-1	-1	-3	-1	3	-1	3	-1	1	3	1	-1	3	1	3	-3	-3	1	-1	-1	1	3

Table 5.5.1.2-3: Definition of $\varphi(n)$ for $M_{sc}^{RS} = N_{sc}^{RB} / 2$

u	$\varphi(0), \dots, \varphi(5)$					
0	-1	-3	3	-3	3	-3
1	-1	3	-1	1	1	1
2	3	-1	-3	-3	1	3
3	3	-1	-1	1	-1	-1
4	-1	-1	-3	1	-3	-1
5	1	3	-3	-1	-3	3
6	-3	3	-1	-1	1	-3
7	-1	-3	-3	1	3	3
8	3	-1	-1	3	1	3
9	3	-3	3	1	-1	1
10	-3	1	-3	-3	-3	-3
11	-3	-3	-3	1	-3	-3
12	3	-3	1	-1	-3	-3
13	3	-3	3	-1	-1	-3
14	3	-1	1	3	3	1
15	-1	1	-1	-3	1	1
16	-3	-1	-3	-1	3	3
17	1	-1	3	-3	3	3
18	1	3	1	1	-3	3
19	-1	-3	-1	-1	3	-3
20	3	-1	-3	-1	-1	-3
21	3	1	3	-3	-3	1
22	1	3	-1	-1	1	-1
23	-3	1	-3	3	3	3
24	1	3	-3	3	-3	3
25	-1	-1	1	-3	1	-1
26	1	-3	-1	-1	3	1
27	-3	-1	-1	3	1	1
28	-1	3	-3	-3	-3	3
29	3	1	-1	1	3	1

Table 5.5.1.2-4: Definition of $\varphi(n)$ for $M_{sc}^{RS} = 3N_{sc}^{RB} / 2$

u	$\varphi(0), \dots, \varphi(17)$																	
0	-3	-3	-3	-3	-3	-1	1	-1	-3	3	-1	3	-1	3	-3	-1	-1	3
1	-3	-3	-3	-3	-3	-1	1	-1	1	-3	-3	-3	1	-1	3	-3	-3	1
2	-3	-3	-3	-3	-3	-1	1	1	3	-3	1	1	-3	1	-3	3	1	-1
3	-3	-3	-3	-3	-3	-1	1	3	-3	-1	3	-1	3	1	-1	-3	3	-3
4	-3	-3	-3	-3	-3	-1	3	-3	-1	1	-1	-3	3	3	1	-3	1	-1
5	-3	-3	-3	-3	-3	1	-3	-3	-3	-3	1	1	1	-3	1	1	-3	-3
6	-3	-3	-3	-3	-3	1	-3	-3	1	1	-3	-3	-3	1	-1	3	-1	3
7	-3	-3	-3	-3	-3	1	-3	-1	3	-1	3	3	-1	-1	1	3	3	-1
8	-3	-3	-3	-3	-3	1	-1	-1	-1	-3	3	-1	3	-3	3	-1	1	3
9	-3	-3	-3	-3	-3	3	-3	1	-1	3	-3	3	3	-1	-3	1	1	-3
10	-3	-3	-3	-3	-3	3	-1	-3	-3	1	1	3	-3	-1	3	-1	3	1
11	-3	-3	-3	-3	-3	3	3	-1	-1	-1	3	1	-3	3	-1	1	-3	1
12	-3	-3	-3	-3	-1	-3	-3	-3	1	3	1	-1	3	-3	-1	-3	1	1
13	-3	-3	-3	-3	-1	-3	-3	1	-1	-1	3	-3	-3	1	3	1	-3	1
14	-3	-3	-3	-3	-1	-3	-3	1	3	-3	-1	3	1	3	-1	3	-1	-3
15	-3	-3	-3	-3	-1	-3	-1	3	-3	1	-3	1	-1	-3	-3	1	1	3
16	-3	-3	-3	-3	-1	-1	3	-3	3	-1	-3	1	1	-1	-3	-1	3	-3
17	-3	-3	-3	-3	-1	-1	3	-1	-3	1	3	-1	-3	-3	1	3	-1	1
18	-3	-3	-3	-3	-1	3	-1	-1	3	3	-1	-3	1	1	1	-1	-3	-1
19	-3	-3	-3	-3	-1	3	1	-3	-1	-3	3	1	-1	3	-1	1	3	-1
20	-3	-3	-3	-3	1	-3	-3	3	1	1	-3	-1	1	3	3	-1	3	-1
21	-3	-3	-3	-3	1	-3	1	3	1	-1	-1	3	3	-1	1	1	-3	3
22	-3	-3	-3	-3	1	-3	3	-3	-1	3	1	1	-1	-1	3	3	-1	3
23	-3	-3	-3	-3	1	-3	3	-1	3	-3	-1	-1	-1	1	-3	-3	3	1
24	-3	-3	-3	-3	1	1	3	1	1	-1	3	1	1	3	-1	-3	1	3
25	-3	-3	-3	-3	1	3	3	3	1	-3	1	-3	-3	3	-3	1	-1	-3
26	-3	-3	-3	-3	3	1	3	3	-1	3	-3	-3	-1	3	-1	-1	-3	1
27	-3	-3	-3	-1	-3	-3	-1	-1	-3	3	3	1	-3	-1	-1	3	1	-3
28	-3	-3	-3	-1	-3	1	-1	1	-3	3	1	-3	-1	1	3	1	-1	-1
29	-3	-3	-3	-1	-3	3	1	1	-1	-1	1	3	1	-3	1	-3	-1	1

5.5.1.3 Group hopping

The sequence-group number u in slot n_s is defined by a group hopping pattern $f_{gh}(n_s)$ and a sequence-shift pattern f_{ss} according to

$$u = (f_{gh}(n_s) + f_{ss}) \bmod 30$$

There are 17 different hopping patterns and 30 different sequence-shift patterns. Sequence-group hopping can be enabled or disabled by means of the cell-specific parameter *Group-hopping-enabled* provided by higher layers. Sequence-group hopping for PUSCH can be disabled for a certain UE through the higher-layer parameter *Disable-sequence-group-hopping* despite being enabled on a cell basis unless the PUSCH transmission corresponds to a Random Access Response Grant or a retransmission of the same transport block as part of the contention based random access procedure.

The group-hopping pattern $f_{gh}(n_s)$ may be different for PUSCH, (S)PUCCH and SRS and is given by

$$f_{gh}(n_s) = \begin{cases} 0 & \text{if group hopping is disabled} \\ \left(\sum_{i=0}^7 c(8n_s + i) \cdot 2^i \right) \bmod 30 & \text{if group hopping is enabled} \end{cases}$$

where the pseudo-random sequence $c(i)$ is defined by clause 7.2. The pseudo-random sequence generator shall be

initialized with $c_{\text{init}} = \left\lfloor \frac{n_{\text{ID}}^{\text{RS}}}{30} \right\rfloor$ at the beginning of each radio frame where $n_{\text{ID}}^{\text{RS}}$ is given by clause 5.5.1.5.

The sequence-shift pattern f_{ss} definition differs between PUCCH, PUSCH and SRS.

For SPUCCH/PUCCH, the sequence-shift pattern f_{ss}^{PUCCH} is given by $f_{ss}^{\text{PUCCH}} = n_{\text{ID}}^{\text{RS}} \bmod 30$ where $n_{\text{ID}}^{\text{RS}}$ is given by clause 5.5.1.5.

For PUSCH, the sequence-shift pattern f_{ss}^{PUSCH} is given by $f_{ss}^{\text{PUSCH}} = (N_{\text{ID}}^{\text{cell}} + \Delta_{ss}) \bmod 30$, where $\Delta_{ss} \in \{0, 1, \dots, 29\}$ is configured by higher layers, if no value for $n_{\text{ID}}^{\text{PUSCH}}$ is provided by higher layers or if the PUSCH transmission corresponds to a Random Access Response Grant or a retransmission of the same transport block as part of the contention based random access procedure, otherwise it is given by $f_{ss}^{\text{PUSCH}} = n_{\text{ID}}^{\text{RS}} \bmod 30$ with $n_{\text{ID}}^{\text{RS}}$ given by clause 5.5.1.5.

For SRS, the sequence-shift pattern f_{ss}^{SRS} is given by $f_{ss}^{\text{SRS}} = n_{\text{ID}}^{\text{RS}} \bmod 30$ where $n_{\text{ID}}^{\text{RS}}$ is given by clause 5.5.1.5.

5.5.1.4 Sequence hopping

Sequence hopping only applies for reference-signals of length $M_{sc}^{RS} \geq 6N_{sc}^{RB}$.

For reference-signals of length $M_{sc}^{RS} < 6N_{sc}^{RB}$, the base sequence number v within the base sequence group is given by $v = 0$.

For reference-signals of length $M_{sc}^{RS} \geq 6N_{sc}^{RB}$, the base sequence number v within the base sequence group in slot n_s is defined by

$$v = \begin{cases} c(n_s) & \text{if group hopping is disabled and sequence hopping is enabled} \\ 0 & \text{otherwise} \end{cases}$$

where the pseudo-random sequence $c(i)$ is given by clause 7.2. The parameter *Sequence-hopping-enabled* provided by higher layers determines if sequence hopping is enabled or not. Sequence hopping for PUSCH can be disabled for a certain UE through the higher-layer parameter *Disable-sequence-group-hopping* despite being enabled on a cell basis unless the PUSCH transmission corresponds to a Random Access Response Grant or a retransmission of the same transport block as part of the contention based random access procedure.

For PUSCH or SPUCCH/PUCCH format 4 transmission with ≥ 6 RBs, the pseudo-random sequence generator shall be initialized with $c_{init} = \left\lfloor \frac{n_{ID}^{RS}}{30} \right\rfloor \cdot 2^5 + f_{ss}^{PUSCH}$ at the beginning of each radio frame where n_{ID}^{RS} is given by clause 5.5.1.5.

For SRS, the pseudo-random sequence generator shall be initialized with $c_{init} = \left\lfloor \frac{n_{ID}^{RS}}{30} \right\rfloor \cdot 2^5 + (n_{ID}^{RS} + \Delta_{ss}) \bmod 30$ at the beginning of each radio frame where n_{ID}^{RS} is given by clause 5.5.1.5 and Δ_{ss} is given by clause 5.5.1.3.

5.5.1.5 Determining virtual cell identity for sequence generation

The definition of n_{ID}^{RS} depends on the type of transmission.

Transmissions associated with PUSCH:

- $n_{ID}^{RS} = N_{ID}^{cell}$ if no value for n_{ID}^{PUSCH} is configured by higher layers or if the PUSCH transmission corresponds to a Random Access Response Grant or a retransmission of the same transport block as part of the contention based random access procedure,
- $n_{ID}^{RS} = n_{ID}^{PUSCH}$ otherwise.

Transmissions associated with SPUCCH/PUCCH:

- $n_{ID}^{RS} = N_{ID}^{cell}$ if no value for n_{ID}^{PUCCH} is configured by higher layers,
- $n_{ID}^{RS} = n_{ID}^{PUCCH}$ otherwise.

Basic sounding reference signals:

- $n_{ID}^{RS} = n_{ID}^{SRS}$ if the higher-layer parameters *nSRS-Identity-Legacy* and *nSRS-Identity* both are configured, where n_{ID}^{SRS} equals the higher-layer parameter *nSRS-Identity*
- $n_{ID}^{RS} = N_{ID}^{cell}$ otherwise.

Additional sounding reference signals:

- $n_{ID}^{RS} = N_{ID}^{cell}$ if no value for n_{ID}^{SRS} is configured by the higher-layer parameter *nSRS-Identity*
- $n_{ID}^{RS} = n_{ID}^{SRS}$ otherwise.

5.5.2 Demodulation reference signal

5.5.2.1 Demodulation reference signal for PUSCH

5.5.2.1.1 Reference signal sequence

The PUSCH demodulation reference signal sequence $r_{\text{PUSCH}}^{(\lambda)}(\cdot)$ associated with layer $\lambda \in \{0, 1, \dots, \nu-1\}$ is defined by

$$r_{\text{PUSCH}}^{(\lambda)}(m \cdot M_{\text{sc}}^{\text{RS}} + n) = w^{(\lambda)}(m) r_{u,v}^{(\alpha_\lambda, \delta)}(n)$$

where

$$m = \begin{cases} 0 & \text{for special subframe and (sub)slot - PUSCH} \\ 0, 1 & \text{otherwise} \end{cases}$$

$$n = 0, \dots, M_{\text{sc}}^{\text{RS}} - 1$$

and $M_{\text{sc}}^{\text{RS}} = M_{\text{sc}}^{\text{PUSCH}}/2$ if

- the higher-layer parameter *ul-DMRS-IFDMA* is set and the most recent uplink-related DCI contains the *Cyclic Shift Field mapping table for DMRS bit* field which is set to 1 to indicate the use of Table 5.5.2.1.1-3, or,
- the *Cyclic Shift Field mapping table for DMRS bit* field is set to 1 in the most recent uplink-related DCI format 7 which indicates the use of Table 5.5.2.1.1-4, or,
- subslot-PUSCH/slot-PUSCH for the transport block is semi-persistently scheduled (i.e. higher layer parameter *sps-ConfigUL-STTI* is configured, see 3GPP TS 36.331 [9]), and *ifdma-Config-SPS* is set.

In all other cases, $M_{\text{sc}}^{\text{RS}} = M_{\text{sc}}^{\text{PUSCH}}$.

Clause 5.5.1 defines the sequence $r_{u,v}^{(\alpha_\lambda, \delta)}(0), \dots, r_{u,v}^{(\alpha_\lambda, \delta)}(M_{\text{sc}}^{\text{RS}} - 1)$ where, for PUSCH demodulation reference signal sequence, $\delta = 1$ when

- the higher-layer parameter *ul-DMRS-IFDMA* is set and the most recent uplink-related DCI contains the *Cyclic Shift Field mapping table for DMRS bit* field which is set to 1 to indicate the use of Table 5.5.2.1.1-3, or,
- the *Cyclic Shift Field mapping table for DMRS bit* field is set to 1 in the most recent uplink-related DCI format 7 which indicates the use of Table 5.5.2.1.1-4, or,
- subslot-PUSCH/slot-PUSCH for the transport block is semi-persistently scheduled (i.e. higher layer parameter *sps-ConfigUL-STTI* is configured, see 3GPP TS 36.331 [9]), and *ifdma-Config-SPS* is set.

In all other cases, $\delta = 0$.

The orthogonal sequence $w^{(\lambda)}(m)$ is given by $w^{(\lambda)}(m) = 1$ for subslot-PUSCH/slot-PUSCH. In all other cases, it is given by $\begin{bmatrix} w^{(\lambda)}(0) & w^{(\lambda)}(1) \end{bmatrix} = \begin{bmatrix} 1 & 1 \end{bmatrix}$ for DCI format 0 if the higher-layer parameter *Activate-DMRS-with OCC* is not set or if the temporary C-RNTI was used to transmit the most recent uplink-related DCI for the transport block associated with the corresponding PUSCH transmission. Otherwise,

- if higher-layer parameter *ul-DMRS-IFDMA* is not set, $w^{(\lambda)}(m)$ is given by Table 5.5.2.1.1-1 using the cyclic shift field in the most recent uplink-related DCI [3],
- if higher-layer parameter *ul-DMRS-IFDMA* is set and the *Cyclic Shift Field mapping table for DMRS bit* field is not present in the most recent uplink-related DCI, $w^{(\lambda)}(m)$ is given by Table 5.5.2.1.1-1 using the cyclic shift field in the most recent uplink-related DCI,
- if higher-layer parameter *ul-DMRS-IFDMA* is set and the *Cyclic Shift Field mapping table for DMRS bit* field is present in the most recent uplink-related DCI, $w^{(\lambda)}(m)$ is given by Table 5.5.2.1.1-1 using the cyclic shift field

in the most recent uplink-related DCI when the *Cyclic Shift Field mapping table for DMRS bit* field is set to 0, and

- if higher-layer parameter *ul-DMRS-IFDMA* is set and the *Cyclic Shift Field mapping table for DMRS bit* field is present in the most recent uplink-related DCI, $w^{(\lambda)}(m)$ is given by Table 5.5.2.1.1-3 using the cyclic shift field in the most recent uplink-related DCI when the *Cyclic Shift Field mapping table for DMRS bit* field is set to 1.

The cyclic shift α_λ in a slot n_s is given as $\alpha_\lambda = 0$ if the ul-V-SPS-RNTI-r14 was used to transmit the most recent uplink-related DCI for the transport block associated with the corresponding PUSCH transmission. For PUSCH transmissions not using sub-PRB allocations, if *pusch-CyclicShift* in higher layer parameter *PUR-PUSCH-Config* is configured it provides the value of $n_{cs,\lambda}$ and the cyclic shift α_λ in a slot n_s is given as $\alpha_\lambda = 2\pi n_{cs,\lambda}/12$.

Otherwise, the cyclic shift α_λ in a slot n_s is given as $\alpha_\lambda = 2\pi n_{cs,\lambda}/12$ with

$$n_{cs,\lambda} = (n_{\text{DMRS}}^{(1)} + n_{\text{DMRS},\lambda}^{(2)} + (1 + \delta)n_{\text{PN}}(n_s)) \bmod 12$$

where the value of $n_{\text{DMRS}}^{(1)}$ is given by Table 5.5.2.1.1-2 according to the parameter *cyclicShift* provided by higher layers. For non-BL/CE UEs $n_{\text{DMRS},\lambda}^{(2)}$ is given using the most recent uplink-related DCI 3GPP TS 36.212 [3] for the transport block associated with the corresponding PUSCH transmission, except for subslot-PUSCH/slot-PUSCH, as follows:

- if the higher-layer parameter *ul-DMRS-IFDMA* is not set, $n_{\text{DMRS},\lambda}^{(2)}$ is given by Table 5.5.2.1.1-1 using the cyclic shift field in the most recent uplink-related DCI,
- if higher-layer parameter *ul-DMRS-IFDMA* is set and the *Cyclic Shift Field mapping table for DMRS bit* field is not present in the most recent uplink-related DCI, $n_{\text{DMRS},\lambda}^{(2)}$ is given by Table 5.5.2.1.1-1 using the cyclic shift field in the most recent uplink-related DCI,
- if higher-layer parameter *ul-DMRS-IFDMA* is set and the *Cyclic Shift Field mapping table for DMRS bit* field is present in the most recent uplink-related DCI, $n_{\text{DMRS},\lambda}^{(2)}$ is given by Table 5.5.2.1.1-1 using the cyclic shift field in the most recent uplink-related DCI when the *Cyclic Shift Field mapping table for DMRS bit* field is set to 0, and
- if higher-layer parameter *ul-DMRS-IFDMA* is set and the *Cyclic Shift Field mapping table for DMRS bit* field is present in the most recent uplink-related DCI, $n_{\text{DMRS},\lambda}^{(2)}$ is given by Table 5.5.2.1.1-3 using the cyclic shift field in the most recent uplink-related DCI when the *Cyclic Shift Field mapping table for DMRS bit* field is set to 1.

For subslot-PUSCH/slot-PUSCH for non-BL/CE UEs, $n_{\text{DMRS},\lambda}^{(2)}$ is given by Table 5.5.2.1.1-4, using the cyclic shift field in the most recent uplink-related DCI. If the *Cyclic Shift Field mapping table for DMRS bit* field is set to 0, ϖ in Table 5.5.2.1.1-4 is ignored. If the *Cyclic Shift Field mapping table for DMRS bit* field is set to 1, both $n_{\text{DMRS},\lambda}^{(2)}$ and ϖ are given by Table 5.5.2.1.1-4.

For BL/CE UEs, a cyclic shift field of '000' shall be assumed when determining $n_{\text{DMRS},\lambda}^{(2)}$ from Table 5.5.2.1.1-1.

For subframe-based PUSCH transmission, the first row of Table 5.5.2.1.1-1 shall be used to obtain $n_{\text{DMRS},0}^{(2)}$ and $w^{(\lambda)}(m)$ if there is no uplink-related DCI for the same transport block associated with the corresponding PUSCH transmission, and

- if the initial PUSCH for the same transport block is semi-persistently scheduled and *cyclicShiftSPS* is not configured, or
- if the initial PUSCH for the same transport block is scheduled by the random-access response grant.

An exception applies if subframe-based PUSCH for the transport block is semi-persistently scheduled and the higher-layer parameter *cyclicShiftSPS* is configured. In this case, the value of $n_{\text{DMRS},0}^{(2)}$ is given by Table 5.5.2.1.1-1 according to the higher-layer parameter *cyclicShiftSPS*.

An exception applies if subslot-PUSCH/slot-PUSCH for the transport block is semi-persistently scheduled (see 3GPP TS 36.331, *sps-ConfigUL-sTTI*). In this case:

- $n_{\text{DMRS},0}^{(2)}$ is given by Table 5.5.2.1.1-1 according to the higher-layer parameter *cyclicShiftSPS-STTI* if the higher layer parameter *ifdma-Config-SPS* is not set, and,
- $n_{\text{DMRS},0}^{(2)}$ and ϖ are given by Table 5.5.2.1.1-3 according to the higher-layer parameter *cyclicShiftSPS-STTI* if the higher layer parameter *ifdma-Config-SPS* is set.

The quantity $n_{\text{PN}}(n_s)$ is given by

$$n_{\text{PN}}(n_s) = \sum_{i=0}^7 c(8N_{\text{sym}}^{\text{UL}} \cdot n_s + i) \cdot 2^i$$

where the pseudo-random sequence $c(i)$ is defined by clause 7.2. The application of $c(i)$ is cell-specific. The pseudo-random sequence generator shall be initialized with c_{init} at the beginning of each radio frame. The quantity c_{init} is

given by $c_{\text{init}} = \left\lfloor \frac{N_{\text{ID}}^{\text{cell}}}{30} \right\rfloor \cdot 2^5 + \left((N_{\text{ID}}^{\text{cell}} + \Delta_{\text{ss}}) \bmod 30 \right)$ if no value for $N_{\text{ID}}^{\text{csh_DMRS}}$ is configured by higher layers for

PUSCH/(S)PUCCH format 4/PUCCH format 5 or the PUSCH transmission corresponds to a Random Access Response Grant or a retransmission of the same transport block as part of the contention based random access procedure,

otherwise it is given by $c_{\text{init}} = \left\lfloor \frac{N_{\text{ID}}^{\text{csh_DMRS}}}{30} \right\rfloor \cdot 2^5 + (N_{\text{ID}}^{\text{csh_DMRS}} \bmod 30)$.

The vector of reference signals shall be precoded according to

$$\begin{bmatrix} \tilde{r}_{\text{PUSCH}}^{(0)} \\ \vdots \\ \tilde{r}_{\text{PUSCH}}^{(P-1)} \end{bmatrix} = W \begin{bmatrix} r_{\text{PUSCH}}^{(0)} \\ \vdots \\ r_{\text{PUSCH}}^{(\nu-1)} \end{bmatrix}$$

where P is the number of antenna ports used for PUSCH transmission.

For PUSCH transmission using a single antenna port, $P = 1$, $W = 1$ and $\nu = 1$.

For spatial multiplexing, $P = 2$ or $P = 4$ and the precoding matrix W shall be identical to the precoding matrix used in clause 5.3.3A.2 for precoding of the PUSCH in the same subframe.

Table 5.5.2.1.1-1: Mapping of Cyclic Shift Field in uplink-related DCI format to $n_{\text{DMRS},\lambda}^{(2)}$ and

$$\left[w^{(\lambda)}(0) \quad w^{(\lambda)}(1) \right]$$

Cyclic Shift Field in uplink-related DCI format [3]	$n_{\text{DMRS},\lambda}^{(2)}$				$\left[w^{(\lambda)}(0) \quad w^{(\lambda)}(1) \right]$			
	$\lambda = 0$	$\lambda = 1$	$\lambda = 2$	$\lambda = 3$	$\lambda = 0$	$\lambda = 1$	$\lambda = 2$	$\lambda = 3$

000	0	6	3	9	[1 1]	[1 1]	[1 -1]	[1 -1]
001	6	0	9	3	[1 -1]	[1 -1]	[1 1]	[1 1]
010	3	9	6	0	[1 -1]	[1 -1]	[1 1]	[1 1]
011	4	10	7	1	[1 1]	[1 1]	[1 1]	[1 1]
100	2	8	5	11	[1 1]	[1 1]	[1 1]	[1 1]
101	8	2	11	5	[1 -1]	[1 -1]	[1 -1]	[1 -1]
110	10	4	1	7	[1 -1]	[1 -1]	[1 -1]	[1 -1]
111	9	3	0	6	[1 1]	[1 1]	[1 -1]	[1 -1]

Table 5.5.2.1.1-2: Mapping of cyclicShift to $n_{\text{DMRS}}^{(1)}$ values

cyclicShift	$n_{\text{DMRS}}^{(1)}$
0	0
1	2
2	3
3	4
4	6
5	8
6	9
7	10

Table 5.5.2.1.1-3: Mapping of Cyclic Shift Field in uplink-related DCI format to $n_{\text{DMRS}\lambda}^{(2)}$, ϖ , and $[w^{(\lambda)}(0) \ w^{(\lambda)}(1)]$

Cyclic Shift Field in uplink-related DCI format [3]	ϖ	$n_{\text{DMRS}\lambda}^{(2)}$				$[w^{(\lambda)}(0) \ w^{(\lambda)}(1)]$			
		$\lambda=0$	$\lambda=1$	$\lambda=2$	$\lambda=3$	$\lambda=0$	$\lambda=1$	$\lambda=2$	$\lambda=3$
000	1	0	6	3	9	[1 1]	[1 1]	[1 -1]	[1 -1]
001	1	6	0	9	3	[1 -1]	[1 -1]	[1 1]	[1 1]
010	1	3	9	6	0	[1 -1]	[1 -1]	[1 1]	[1 1]
011	0	4	10	7	1	[1 1]	[1 1]	[1 1]	[1 1]
100	0	2	8	5	11	[1 1]	[1 1]	[1 1]	[1 1]
101	0	8	2	11	5	[1 -1]	[1 -1]	[1 -1]	[1 -1]
110	0	10	4	1	7	[1 -1]	[1 -1]	[1 -1]	[1 -1]
111	1	9	3	0	6	[1 1]	[1 1]	[1 -1]	[1 -1]

Table 5.5.2.1.1-4: $n_{\text{DMRS}\lambda}^{(2)}$ for subslot-PUSCH/slot-PUSCH

Cyclic Shift Field in uplink-related DCI format [3]	$n_{\text{DMRS}, \lambda}^{(2)}$				ϖ			
	$\lambda=0$	$\lambda=1$	$\lambda=2$	$\lambda=3$	$\lambda=0$	$\lambda=1$	$\lambda=2$	$\lambda=3$
0	0	6	3	9	0	0	1	1
1	6	0	9	3	1	1	0	0

5.5.2.1.2 Mapping to physical resources

For each antenna port used for transmission of the PUSCH, the sequence $\tilde{r}_{\text{PUSCH}}^{(\tilde{p})}(\cdot)$ shall be multiplied with the amplitude scaling factor $\sqrt{1+\delta}\beta_{\text{PUSCH}}$ and mapped in sequence starting with $\tilde{r}_{\text{PUSCH}}^{(\tilde{p})}(0)$ to the resource blocks.

- $\delta=1$ when either
 - the higher-layer parameter *ul-DMRS-IFDMA* is set and the most recent uplink-related DCI contains the *Cyclic Shift Field mapping table for DMRS bit* field which is set to 1 to indicate the use of Table 5.5.2.1.1-3, or
 - the *Cyclic Shift Field mapping table for DMRS bit* field is set to 1 in the most recent uplink-related DCI format 7 which indicates the use of Table 5.5.2.1.1-4, and
- $\delta=0$ otherwise.

If higher-layer parameter *ul-DMRS-IFDMA* is set and the most recent uplink-related DCI contains the *Cyclic Shift Field mapping table for DMRS bit* field which is set to 1 to indicate the use of Table 5.5.2.1.1-3, the mapping to resource elements (k,l) , with $l=3$ for normal cyclic prefix and $l=2$ for extended cyclic prefix, in the subframe shall be in increasing order of first k for all values of k satisfying $k \bmod 2 = \varpi$, then the slot number. The quantity ϖ is given by Table 5.5.2.1.1-3 using the cyclic shift field in the most recent uplink-related DCI.

In case of slot-PUSCH, the mapping to resource elements (k,l) , with $l=3$ for normal cyclic prefix, in the slot of the subframe where slot-PUSCH is transmitted shall be in increasing order of first k for all values of k , except if the *Cyclic Shift Field mapping table for DMRS bit* field is set to 1 in the most recent uplink-related DCI format 7, which indicates the use of Table 5.5.2.1.1-4. In this case the mapping to resource element shall be in increasing order of first k only for values of k satisfying $k \bmod 2 = \varpi$.

In case of subslot-PUSCH, the mapping to resource elements (k,l) , in the subframe shall be in increasing order of first k for all values of k , except if the *Cyclic Shift Field mapping table for DMRS bit* field is set to 1 in the most recent uplink-related DCI format 7, which indicates the use of Table 5.5.2.1.1-4. In this case the mapping to resource element shall be in increasing order of first k only for values of k satisfying $k \bmod 2 = \varpi$. The value of l depends on the uplink subslot number and the *DMRS-pattern* field in the most recent uplink-related DCI, according to Table 5.5.2.1.2-1, or according to Table 5.5.2.1.2-2 in case of semi-persistent scheduling of subslot-PUSCH (i.e. higher layer parameter *sps-ConfigUL-sTTI-r15* is configured, see 3GPP TS 36.331 [9]) and with a configured periodicity of 1 subslot (i.e. *semiPersistSchedIntervalUL-STTI-r15* set to *sTTI*). In case of subslot-PUSCH and semi-persistent scheduling with a configured periodicity longer than 1 subslot, the mapping shall start at symbol l according to the first row of Table 5.5.2.1.2-2 (i.e. equivalent to a signalling of *DMRS-pattern* field set to '00'). In case no value of l is defined for the uplink subslot number, and in case no valid starting symbol index (see table 5.3.4-1), no reference signal is transmitted associated with the uplink-related DCI format.

Table 5.5.2.1.2-1: The quantity l for subslot-PUSCH

<i>DMRS-pattern</i> field in uplink-related DCI format [3]	Uplink subslot number					
	#0	#1	#2	#3	#4	#5
00	0	3	5	0	2	4
01	2	4	-	1	3	-
10	-	-	-	2	-	-
11	-	5	-	-	4	-

Table 5.5.2.1.2-2: The quantity l for subslot-PUSCH for semi-persistent scheduling

<i>DMRS-pattern</i> field in uplink-related DCI format [3]	Uplink subslot number					
	#0	#1	#2	#3	#4	#5
00	0	3	5	0	2	4
10	0	5	5	2	2	4

For all other cases, the set of physical resource blocks used in the mapping process and the relation between the index \tilde{p} and the antenna port number p shall be identical to the corresponding PUSCH transmission as defined in clause 5.3.4.

The mapping to resource elements (k, l) , with $l=3$, or with l according to Table 5.5.2.1.2-1 for subslot-PUSCH, for normal cyclic prefix and $l=2$ for extended cyclic prefix, in the subframe shall be in increasing order of first k , then the slot number, except for slot-PUSCH and subslot-PUSCH where the reference signal is only mapped to the slot where the slot-PUSCH/subslot-PUSCH is transmitted). No DM-RS shall be transmitted in UpPTS if *dmrsLess-UpPts* is set to true.

For BL/CE UEs, if higher layer parameter *resourceReservationDedicatedUL* is configured, and the Resource reservation field in the DCI is set to 1, then in case of PUSCH transmission with $N_{\text{rep}}^{\text{PUSCH}} > 1$ associated with C-RNTI or SPS C-RNTI using UE-specific MPDCCH search space including PUSCH transmission without a corresponding MPDCCH,

- In a subframe that is fully reserved as defined in clause 8.0 in [4], the demodulation reference signal transmission is postponed until the next BL/CE uplink subframe that is not fully reserved.
- In a subframe that is partially reserved, the demodulation reference signal transmission in a SC-FDMA symbol that is reserved is dropped.

5.5.2.1A Demodulation reference signal for PUSCH with sub-PRB allocations

5.5.2.1A.1 Reference signal sequence using modulation schemes other than $\pi/2$ -BPSK

The reference signal sequence $r_{\text{PUSCH}}(n)$ for $M_{\text{sc}}^{\text{RU}} > 1$ is defined by a cyclic shift α of a base sequence according to

$$r_{\text{PUSCH}}(n) = e^{j\alpha n} e^{j\phi(n)\pi/4}$$

$$0 \leq n < M_{\text{sc}}^{\text{RU}}$$

where $\phi(n)$ is given by Tables 5.5.2.1A.1-1 and 5.5.2.1A.1-2 for $M_{\text{sc}}^{\text{RU}} = 3$ and $M_{\text{sc}}^{\text{RU}} = 6$, respectively. The cyclic shift α is derived from higher layer parameters *threeTone-CyclicShift* and *sixTone-CyclicShift*, respectively, as defined in Table 5.5.2.1A.1-3.

If group hopping is enabled, the base sequence index u is given by clause 5.5.2.1A.3.

If group hopping is not enabled, the base sequence index u is given by

- $N_{\text{ID}}^{\text{cell}} \bmod 12$ for $M_{\text{sc}}^{\text{RU}} = 3$
- $N_{\text{ID}}^{\text{cell}} \bmod 14$ for $M_{\text{sc}}^{\text{RU}} = 6$

Table 5.5.2.1A.1-1: Definition of $\phi(n)$ for $M_{\text{sc}}^{\text{RU}} = 3$

u	$\phi(0), \dots, \phi(2)$		
0	1	-3	-3
1	1	-3	-1
2	1	-3	3
3	1	-1	-1
4	1	-1	1
5	1	-1	3
6	1	1	-3
7	1	1	-1
8	1	1	3
9	1	3	-1
10	1	3	1
11	1	3	3

Table 5.5.2.1A.1-2: Definition of $\phi(n)$ for $M_{sc}^{RU} = 6$

u	$\phi(0), \dots, \phi(5)$					
0	1	1	1	1	3	-3
1	1	1	3	1	-3	3
2	1	-1	-1	-1	1	-3
3	1	-1	3	-3	-1	-1
4	1	3	1	-1	-1	3
5	1	-3	-3	1	3	1
6	-1	-1	1	-3	-3	-1
7	-1	-1	-1	3	-3	-1
8	3	-1	1	-3	-3	3
9	3	-1	3	-3	-1	1
10	3	-3	3	-1	3	3
11	-3	1	3	1	-3	-1
12	-3	1	-3	3	-3	-1
13	-3	3	-3	1	1	-3

Table 5.5.2.1A.1-3: Definition of α

$M_{sc}^{RU} = 3$ <i>threeTone-CyclicShift</i>		α	$M_{sc}^{RU} = 6$ <i>sixTone-CyclicShift</i>		α
0		0	0		0
1		$2\pi/3$	1		$2\pi/6$
2		$4\pi/3$	2		$4\pi/6$
-		-	3		$8\pi/6$

5.5.2.1A.2 Reference signal sequence using $\pi/2$ -BPSK modulation scheme

For $M_{sc}^{RU} = 3$ using $\pi/2$ -BPSK modulation scheme, $N_{ID}^{cell} \bmod 2$ is used to determine which 2 of 3 subcarriers will be used:

- 0 indicates that the two subcarriers having the lowest indices among the three allocated are utilized.
- 1 indicates that the two subcarriers having the highest indices among the three allocated are utilized.

The reference signal sequences $\bar{r}_{u1}(n)$ and $\bar{r}_{u2}(n)$ for $M_{sc}^{RU} = 3$ using 2 out of 3 subcarriers are defined by

$$\bar{r}_{u1}(n) = \frac{1}{\sqrt{2}}(1+j)(1-2c(n))w(n \bmod 16), \quad 0 \leq n < N_{rep}^{PUSCH} M_{slots}^{UL} M_{RU}$$

$$\bar{r}_{u2}(n) = (-1)^n \left(\frac{1}{\sqrt{2}}(1+j)(1-2c(n))w(n \bmod 16) \right), \quad 0 \leq n < N_{rep}^{PUSCH} M_{slots}^{UL} M_{RU}$$

where the binary sequence $c(n)$ is defined by clause 7.2 and shall be initialised with $c_{init} = 35$ at the start of the PUSCH transmission using sub-PRB allocations for BL/CE UEs. The quantity $w(n)$ is given by Table 5.5.2.1A.2-1 where $u = N_{ID}^{cell} \bmod 16$ if group hopping is not enabled, and by clause 5.5.2.1A.3 if group hopping is enabled for PUSCH using sub-PRB allocations for BL/CE UEs.

Table 5.5.2.1A.2-1: Definition of $w(n)$

u	$w(0), \dots, w(15)$															
0	1	1	1	1	1	1	1	1	1	1	1	1	1	1	1	1
1	1	-1	1	-1	1	-1	1	-1	1	-1	1	-1	1	-1	1	-1
2	1	1	-1	-1	1	1	-1	-1	1	1	-1	-1	1	1	-1	-1
3	1	-1	-1	1	1	-1	-1	1	1	-1	-1	1	1	-1	-1	1
4	1	1	1	1	-1	-1	-1	-1	1	1	1	1	-1	-1	-1	-1
5	1	-1	1	-1	-1	1	-1	1	1	-1	1	-1	-1	1	-1	1
6	1	1	-1	-1	-1	-1	1	1	1	1	-1	-1	-1	-1	1	1
7	1	-1	-1	1	1	-1	1	1	-1	1	-1	-1	1	-1	1	-1
8	1	1	1	1	1	1	1	1	-1	-1	-1	-1	-1	-1	-1	-1
9	1	-1	1	-1	1	-1	1	-1	-1	1	-1	1	-1	1	-1	1
10	1	1	-1	-1	1	1	-1	-1	-1	-1	1	1	-1	-1	1	1
11	1	-1	-1	1	1	-1	-1	1	-1	1	1	-1	-1	1	1	-1
12	1	1	1	1	-1	-1	-1	-1	-1	-1	-1	-1	1	1	1	1
13	1	-1	1	-1	-1	1	-1	1	-1	1	-1	1	1	-1	1	-1
14	1	1	-1	-1	-1	-1	1	1	-1	-1	1	1	1	1	-1	-1
15	1	-1	-1	1	-1	1	1	-1	-1	1	1	-1	1	-1	-1	1

The reference signal sequences for PUSCH using sub-PRB allocations for BL/CE UEs is given by clause 5.3.3, where $\bar{r}_{u1}(n)$ and $\bar{r}_{u2}(n)$ correspond to the complex-valued symbols at the input of the transform precoding. The resulting complex-valued symbols at the output of the transform precoding correspond to the sequence $r(\cdot)$ which is mapped to physical resources as described in clause 5.5.2.1A.4.

5.5.2.1A.3 Group hopping

For the reference signal for PUSCH transmission using sub-PRB allocations for BL/CE UEs, sequence-group hopping can be enabled where the sequence-group number u in slot n_s of a radio frame n_f is defined by a group hopping pattern $f_{gh}(n')$ and a sequence-shift pattern f_{ss} according to

$$u = (f_{gh}(n') + f_{ss}) \bmod M_{\text{seq}}^{\text{RU}}$$

where the number of reference signal sequences available for each resource unit size, $M_{\text{seq}}^{\text{RU}}$ is given by Table 5.5.2.1A.3-1.

Table 5.5.2.1A.3-1: Definition of $M_{\text{seq}}^{\text{RU}}$

Modulation Scheme	$M_{\text{sc}}^{\text{RU}}$	$M_{\text{seq}}^{\text{RU}}$
$\pi/2$ -BPSK	3	16
QPSK	3	12
	6	14

Sequence-group hopping can be enabled or disabled as described in clause 5.5.1.3.

The group-hopping pattern $f_{gh}(n')$ is given by

$$f_{gh}(n') = (\sum_{i=0}^7 c(8n' + i) \cdot 2^i) \bmod M_{\text{seq}}^{\text{RU}}$$

where $n' = n_s$ for $M_{\text{sc}}^{\text{RU}} > 1$ using QPSK modulation scheme. When $M_{\text{sc}}^{\text{RU}} = 3$ using $\pi/2$ -BPSK modulation scheme, for frame structure type 1, n' is the slot number n_s of the first slot of the resource unit, and for frame structure type 2, n' is the frame number n_f of the first slot of the resource unit. The pseudo-random sequence $c(i)$ is defined by clause 7.2.

The pseudo-random sequence generator shall be initialized with $c_{\text{init}} = \lfloor N_{\text{ID}}^{\text{cell}} / M_{\text{seq}}^{\text{RU}} \rfloor$ at the beginning of the resource unit for $M_{\text{sc}}^{\text{RU}} = 3$ using $\pi/2$ -BPSK modulation scheme and in every even slot for $M_{\text{sc}}^{\text{RU}} > 1$ using QPSK modulation scheme.

The sequence-shift pattern f_{ss} is given by

$$f_{ss}(n_s) = (N_{ID}^{cell} + \Delta_{ss}) \bmod M_{seq}^{RU}$$

where $\Delta_{ss} = 0$.

5.5.2.1A.4 Mapping to physical resources

The sequence $r(\cdot)$ shall be multiplied with the amplitude scaling factor β_{PUSCH} and mapped in sequence starting with $r(0)$ to the sub-carriers.

The set of sub-carriers used in the mapping process shall be identical to the corresponding PUSCH transmissions using sub-PRB allocations for BL/CE UEs as defined in clause 5.3.4.

The mapping to resource elements (k, l) shall be in increasing order of first k , then l , and finally the slot number. The value of the symbol index l in a slot is 3.

For BL/CE UEs, if higher layer parameter *resourceReservationDedicatedUL* is configured, and the Resource reservation field in the DCI is set to 1, then in case of PUSCH transmission with $N_{rep}^{PUSCH} > 1$ associated with C-RNTI or SPS C-RNTI using UE-specific MPDCCH search space including PUSCH transmission without a corresponding MPDCCH,

- In a subframe that is fully reserved as defined in clause 8.0 in [4], the demodulation reference signal transmission is postponed until the next BL/CE uplink subframe that is not fully reserved.
- In a subframe that is partially reserved, the demodulation reference signal transmission in a SC-FDMA symbol that is reserved is dropped.

5.5.2.2 Demodulation reference signal for PUCCH

5.5.2.2.1 Reference signal sequence

The PUCCH demodulation reference signal sequence $r_{PUCCH}^{(\tilde{p})}(\cdot)$ for PUCCH formats 1, 1a, 1b, 2, 2a, 2b, and 3 is defined by

$$r_{PUCCH}^{(\tilde{p})}(m' N_{RS}^{PUCCH} M_{sc}^{RS} + m M_{sc}^{RS} + n) = \frac{1}{\sqrt{P}} \bar{w}^{(\tilde{p})}(m) z(m) r_{u,v}^{(\alpha_{\tilde{p}}, \delta)}(n)$$

where

$$\begin{aligned} m &= 0, \dots, N_{RS}^{PUCCH} - 1 \\ n &= 0, \dots, M_{sc}^{RS} - 1 \\ m' &= 0, 1 \end{aligned}$$

and P is the number of antenna ports used for PUCCH transmission. For PUCCH formats 2a and 2b, $z(m)$ equals $d(10)$ for $m = 1$, where $d(10)$ is defined in clause 5.4.2. For all other cases, $z(m) = 1$.

The sequence $r_{u,v}^{(\alpha_{\tilde{p}})}(n)$ is given by clause 5.5.1 with $M_{sc}^{RS} = 12$ and $\delta = 0$ where the expression for the cyclic shift $\alpha_{\tilde{p}}$ is determined by the PUCCH format.

For PUCCH formats 1, 1a and 1b, $\alpha_{\tilde{p}}(n_s, l)$ is given by

$$\bar{n}_{oc}^{(\tilde{p})}(n_s) = \lfloor n'_{\tilde{p}}(n_s) \cdot \Delta_{\text{shift}}^{\text{PUCCH}} / N' \rfloor$$

$$\alpha_{\tilde{p}}(n_s, l) = 2\pi \cdot \bar{n}_{cs}^{(\tilde{p})}(n_s, l) / N_{sc}^{\text{RB}}$$

$$\bar{n}_{cs}^{(\tilde{p})}(n_s, l) = \begin{cases} \left[n_{cs}^{\text{cell}}(n_s, l) + \left(n'_{\tilde{p}}(n_s) \cdot \Delta_{\text{shift}}^{\text{PUCCH}} + \left(\bar{n}_{oc}^{(\tilde{p})}(n_s) \bmod \Delta_{\text{shift}}^{\text{PUCCH}} \right) \right) \bmod N' \right] \bmod N_{sc}^{\text{RB}} & \text{for normal cyclic prefix} \\ \left[n_{cs}^{\text{cell}}(n_s, l) + \left(n'_{\tilde{p}}(n_s) \cdot \Delta_{\text{shift}}^{\text{PUCCH}} + \bar{n}_{oc}^{(\tilde{p})}(n_s) \right) \bmod N' \right] \bmod N_{sc}^{\text{RB}} & \text{for extended cyclic prefix} \end{cases}$$

where $n'_{\tilde{p}}(n_s)$, N' , $\Delta_{\text{shift}}^{\text{PUCCH}}$ and $n_{cs}^{\text{cell}}(n_s, l)$ are defined by clause 5.4.1. The number of reference symbols per slot N_{RS}^{PUCCH} and the sequence $\bar{w}(n)$ are given by Table 5.5.2.2.1-1 and 5.5.2.2.1-2, respectively.

For PUCCH formats 2, 2a and 2b, $\alpha_{\tilde{p}}(n_s, l)$ is defined by clause 5.4.2. The number of reference symbols per slot N_{RS}^{PUCCH} and the sequence $\bar{w}^{(\tilde{p})}(n)$ are given by Table 5.5.2.2.1-1 and 5.5.2.2.1-3, respectively.

For PUCCH format 3, $\alpha_{\tilde{p}}(n_s, l)$ is given by

$$\alpha_{\tilde{p}}(n_s, l) = 2\pi \cdot n_{cs}^{(\tilde{p})}(n_s, l) / N_{sc}^{\text{RB}}$$

$$n_{cs}^{(\tilde{p})}(n_s, l) = \left(n_{cs}^{\text{cell}}(n_s, l) + n'_{\tilde{p}}(n_s) \right) \bmod N_{sc}^{\text{RB}}$$

where $n'_{\tilde{p}}(n_s)$ is given by Table 5.5.2.2.1-4 and $n_{oc,0}^{(\tilde{p})}$ and $n_{oc,1}^{(\tilde{p})}$ for the first and second slot in a subframe, respectively, are obtained from clause 5.4.2A. The number of reference symbols per slot N_{RS}^{PUCCH} and the sequence $\bar{w}(n)$ are given by Table 5.5.2.2.1-1 and 5.5.2.2.1-3, respectively.

Table 5.5.2.2.1-1: Number of PUCCH demodulation reference symbols per slot N_{RS}^{PUCCH}

PUCCH format	Normal cyclic prefix	Extended cyclic prefix
1, 1a, 1b	3	2
2, 3	2	1
2a, 2b	2	N/A

Table 5.5.2.2.1-2: Orthogonal sequences $\left[\bar{w}^{(\tilde{p})}(0) \dots \bar{w}^{(\tilde{p})}(N_{RS}^{\text{PUCCH}} - 1) \right]$ for PUCCH formats 1, 1a and 1b

Sequence index $\bar{n}_{oc}^{(\tilde{p})}(n_s)$	Normal cyclic prefix	Extended cyclic prefix
0	$[1 \ 1 \ 1]$	$[1 \ 1]$
1	$[1 \ e^{j2\pi/3} \ e^{j4\pi/3}]$	$[1 \ -1]$
2	$[1 \ e^{j4\pi/3} \ e^{j2\pi/3}]$	N/A

Table 5.5.2.2.1-3: Orthogonal sequences $\left[\bar{w}^{(\tilde{p})}(0) \dots \bar{w}^{(\tilde{p})}(N_{RS}^{\text{PUCCH}} - 1) \right]$ for PUCCH formats 2, 2a, 2b and 3.

Normal cyclic prefix	Extended cyclic prefix
$[1 \ 1]$	$[1]$

Table 5.5.2.2.1-4: Relation between $n_{oc}^{(\tilde{p})}$ and $n_{\tilde{p}}'(n_s)$ for PUCCH format 3.

$n_{oc}^{(\tilde{p})}$	$n_{\tilde{p}}'(n_s)$	
	$N_{SF,1} = 5$	$N_{SF,1} = 4$
0	0	0
1	3	3
2	6	6
3	8	9
4	10	N/A

The PUCCH demodulation reference signal sequence $r_{PUCCH}^{(\tilde{p})}(\cdot)$ for PUCCH formats 4 and 5 is defined by

$$r_{PUCCH}^{(\tilde{p})}(m \cdot M_{sc}^{RS} + n) = r_{u,v}^{(\alpha,\delta)}(n)$$

where

$$\begin{aligned} \tilde{p} &= 0 \\ m &= 0,1 \\ n &= 0, \dots, M_{sc}^{RS} - 1 \end{aligned}$$

and

$$M_{sc}^{RS} = \begin{cases} M_{sc}^{PUCCH4} & \text{for PUCCH format 4} \\ N_{sc}^{RB} & \text{for PUCCH format 5} \end{cases}$$

Clause 5.5.1 defines the sequence $r_{u,v}^{(\alpha_\lambda,\delta)}(0), \dots, r_{u,v}^{(\alpha_\lambda,\delta)}(M_{sc}^{RS} - 1)$ where $\delta = 0$.

The cyclic shift α_λ in a slot n_s is given as $\alpha_\lambda = 2m_{cs,\lambda}/12$ with

$$n_{cs,\lambda} = (n_{DMRS}^{(1)} + n_{DMRS}^{(2)} + n_{PN}(n_s)) \bmod 2$$

where the values of $n_{DMRS}^{(1)}$ and $n_{PN}(n_s)$ are given by Clause 5.5.2.1.1 and

$$n_{DMRS}^{(2)} = \begin{cases} 0 & \text{PUCCH format 4} \\ 0 & \text{PUCCH format 5 with } n_{oc} = 0 \\ 6 & \text{PUCCH format 5 with } n_{oc} = 1 \end{cases}$$

with n_{oc} obtained as described in clause 5.4.2C.

5.5.2.2.2 Mapping to physical resources

The sequence $r_{PUCCH}^{(\tilde{p})}(\cdot)$ shall be multiplied with the amplitude scaling factor β_{PUCCH} and mapped in sequence starting with $r_{PUCCH}^{(\tilde{p})}(0)$ to resource elements (k, l) on antenna port p . The mapping shall be in increasing order of first k , then l and finally the slot number. The set of values for k and the relation between the index \tilde{p} and the antenna port number p shall be identical to the values used for the corresponding PUCCH transmission. The values of the symbol index l in a slot are given by Table 5.5.2.2.2-1.

Table 5.5.2.2-1: Demodulation reference signal location for different PUCCH formats.

PUCCH format	Set of values for l	
	Normal cyclic prefix	Extended cyclic prefix
1, 1a, 1b	2, 3, 4	2, 3
2, 3	1, 5	3
2a, 2b	1, 5	N/A
4,5	3	2

For BL/CE UEs, if higher layer parameter *resourceReservationDedicatedUL* is configured, then in case of PUCCH transmission with $N_{rep}^{PUCCH} > 1$ associated with C-RNTI or SPS C-RNTI using UE-specific MPDCCH search space including PUCCH transmission without a corresponding MPDCCH,

- In a subframe that is fully reserved as defined in clause 8.0 in [4], the demodulation reference signal transmission is postponed until the next BL/CE uplink subframe that is not fully reserved.
- In a subframe that is partially reserved, the demodulation reference signal transmission in a SC-FDMA symbol that is reserved is dropped.

5.5.2.3 Demodulation reference signal for SPUCCH

5.5.2.3.1 Reference signal sequence

The SPUCCH demodulation reference signal sequence $r_{SPUCCH}^{(\tilde{p})}(n)$ for subslot-SPUCCH format 4, and, slot-SPUCCH formats 1, 1a, 1b, 3 and 4 is as defined for $r_{PUCCH}^{(\tilde{p})}(n)$ in clause 5.5.2.2.1 for PUCCH format 1, 1a, 1b, 2, 2a, 2b and 3, using the parameter settings in Table 5.5.2.3.1-1, and with the number of reference symbols N_{RS}^{PUCCH} replaced by N_{RS}^{SPUCCH} and given by Table 5.5.2.3.1-2.

NOTE: Subslot-SPUCCH format 1/1a/1b does not employ a reference signal based design.

The sequence $r_{u,v}^{(\alpha_{\tilde{p}})}(n)$ is given by clause 5.5.1 with $\delta = 0$, where the expression for the cyclic shift α is determined depending on the SPUCCH format, see table 5.5.2.3.1-3.

Table 5.5.2.3.1-1: Parameters for SPUCCH demodulation reference signal

SPUCCH format		Frequency hopping	m^l	M_{sc}^{RS}	$\overline{w}^{(\tilde{p})}(m)$	$z(m)$
Slot	1, 1a, 1b	Disabled	0	12	See Table 5.5.2.2.1-2 for normal cyclic prefix	1
		Enabled	0	12	1	1
	3	Disabled	0	12	See clause 5.5.2.2.2	1
	4	Enabled	0	$M_{sc}^{SPUCCH4}$	1	1
Subslot	4	Disabled	0	$M_{sc}^{SPUCCH4}$	1	1

Table 5.5.2.3.1-2: Number of SPUCCH demodulation reference symbols N_{RS}^{SPUCCH} per slot or per subslot

SPUCCH format		Frequency hopping	N_{RS}^{SPUCCH}
Slot	1, 1a, 1b	Enabled or disabled	3
	3	Disabled	2
	4	Enabled	2
Subslot	4	Disabled	1

Table 5.5.2.3.1-3: α

SPUCCH format		Frequency hopping	α
Slot	1, 1a, 1b	Enabled or disabled	see $\alpha_{\tilde{p}}$ in clause 5.4A.2
	3	Disabled	see $\alpha_{\tilde{p}}$ for PUCCH format 3 in clause 5.5.2.2.1 and determining $n_{oc,0}^{(\tilde{p})}$ and $n_{oc,1}^{(\tilde{p})}$ in clause 5.4A.3.1
	4	Enabled	see α_{λ} for PUCCH format 4 in clause 5.5.2.2.1
Subslot	4	Disabled	see α_{λ} for PUCCH format 4 in clause 5.5.2.2.1

5.5.2.3.2 Mapping to physical resources

The sequence $r_{\text{SPUCCH}}^{(\tilde{p})}(i)$ shall be multiplied with the amplitude scaling factor β_{SPUCCH} and mapped in sequence starting with $r_{\text{SPUCCH}}^{(\tilde{p})}(0)$ to resource elements (k,l) on antenna port p . The mapping shall be in increasing order of first k , then l . The set of values for k and the relation between the index \tilde{p} and the antenna port number p shall be identical to the values used for the corresponding SPUCCH transmission. The values of the symbol index l in a slot and a subslot are given by Table 5.5.2.3.2-1 and Table 5.5.2.3.2-2 respectively.

Table 5.5.2.3.2-1: Demodulation reference signal location for different slot-SPUCCH formats

SPUCCH format	Frequency hopping	Slot	Set of values for l
1, 1a, 1b	Enabled	1 st	1, 4, 5
		2 nd	1, 2, 5
	Disabled	1 st and 2 nd	2, 3, 4
3	Disabled	1 st and 2 nd	1, 5
4	Enabled	1 st and 2 nd	1, 5

Table 5.5.2.3.2-2: Demodulation reference signal location for different subslot-SPUCCH formats

SPUCCH format	Subslot number in subframe	Slot	l
4	0	1 st	0
	1	1 st	3
	2	1 st	5
	3	2 nd	0
	4	2 nd	2
	5	2 nd	4

5.5.3 Sounding reference signal

Two types of sounding reference signals can be configured:

- basic sounding reference signal, supporting periodic or aperiodic transmission
- additional sounding reference signal, supporting aperiodic transmission only

5.5.3.1 Sequence generation

5.5.3.1.1 Sequence generation for basic SRS

The sounding reference signal sequence $r_{\text{SRS}}^{(\tilde{p})}(n) = r_{u,v}^{(\alpha_{\tilde{p}}, \delta)}(n)$ is defined by clause 5.5.1, where u is the sequence-group number defined in clause 5.5.1.3, v is the base sequence number defined in clause 5.5.1.4, and $\delta = 0$. The cyclic shift $\alpha_{\tilde{p}}$ of the sounding reference signal is given as

$$\alpha_{\tilde{p}} = 2\pi \frac{n_{\text{SRS}}^{\text{cs}, \tilde{p}}}{n_{\text{SRS}}^{\text{cs}, \text{max}}}$$

$$n_{\text{SRS}}^{\text{cs}, \tilde{p}} = \left(n_{\text{SRS}}^{\text{cs}} + \frac{n_{\text{SRS}}^{\text{cs}, \text{max}} \tilde{p}}{N_{\text{ap}}} \right) \bmod n_{\text{SRS}}^{\text{cs}, \text{max}},$$

$$\tilde{p} \in \{0, 1, \dots, N_{\text{ap}} - 1\}$$

where $n_{\text{SRS}}^{\text{cs}} = \{0, 1, \dots, n_{\text{SRS}}^{\text{cs}, \text{max}} - 1\}$ is configured separately for periodic and each configuration of aperiodic sounding by the higher-layer parameters *cyclicShift* and *cyclicShift-ap*, respectively, for each UE and N_{ap} is the number of antenna ports used for sounding reference signal transmission. The parameter $n_{\text{SRS}}^{\text{cs}, \text{max}} = 8$ if $K_{\text{TC}} = 2$, otherwise $n_{\text{SRS}}^{\text{cs}, \text{max}} = 12$. The parameter K_{TC} is given by the higher layer parameter *transmissionCombNum* if configured, otherwise $K_{\text{TC}} = 2$.

5.5.3.1.2 Sequence generation for additional SRS

The sounding reference signal $r_{\text{SRS}}^{(\tilde{p})}(n)$ is defined by clause 5.5.3.1.1 with the following exceptions

- $n_{\text{SRS}}^{\text{cs}}$ is given by the higher-layer parameter *additionalSRS-cyclicShift*
- N_{ap} is given by the higher-layer parameter *additionalSRS-AntennaPort*
- K_{TC} is given by the higher-layer parameter *additionalSRS-transmissionComb*
- the function f_{gh} in clause 5.5.1.3 is given by

$$f_{\text{gh}}(n_s, l) = \begin{cases} 0 & \text{if group hopping is disabled} \\ \left(\sum_{i=0}^7 2^i c(8(n_s N_{\text{symb}}^{\text{UL}} + l) + i) \right) \bmod 30 & \text{if group hopping is enabled} \end{cases}$$

where l is the OFDM symbol index within the slot n_s and $N_{\text{symb}}^{\text{UL}}$ is the number of OFDM symbols per slot

- the function v in clause 5.5.1.4 is given by

$$v = \begin{cases} c(n_s N_{\text{symb}}^{\text{UL}} + l) & \text{if group hopping is disabled and sequence hopping is enabled} \\ 0 & \text{otherwise} \end{cases}$$

5.5.3.2 Mapping to physical resources

5.5.3.2.1 Mapping to physical resources for basic SRS

The sequence shall be multiplied with the amplitude scaling factor β_{SRS} in order to conform to the transmit power P_{SRS} specified in clause 5.1.3.1 in 3GPP TS 36.213 [4], and mapped in sequence starting with $r_{\text{SRS}}^{(\tilde{p})}(0)$ to resource elements (k, l) on antenna port p according to

$$a_{K_{\text{TC}}k+k_0^{(p)}, l}^{(p)} = \begin{cases} \frac{1}{\sqrt{N_{\text{ap}}}} \beta_{\text{SRS}} r_{\text{SRS}}^{(\tilde{p})}(k') & k' = 0, 1, \dots, M_{\text{sc}, b}^{\text{RS}} - 1 \\ 0 & \text{otherwise} \end{cases}$$

where N_{ap} is the number of antenna ports used for sounding reference signal transmission and the relation between the index \tilde{p} and the antenna port p is given by Table 5.2.1-1. The set of antenna ports used for sounding reference signal transmission is configured independently for periodic and each configuration of aperiodic sounding. The quantity $k_0^{(p)}$ is the frequency-domain starting position of the sounding reference signal and for $b = B_{\text{SRS}}$ and $M_{\text{sc}, b}^{\text{RS}}$ is the length of the sounding reference signal sequence defined as

$$M_{\text{sc}, b}^{\text{RS}} = m_{\text{SRS}, b} N_{\text{sc}}^{\text{RB}} / K_{\text{TC}}$$

where $m_{\text{SRS}, b}$ is given by Table 5.5.3.2-1 through Table 5.5.3.2-4 for each uplink bandwidth $N_{\text{RB}}^{\text{UL}}$. The cell-specific parameter *srs-BandwidthConfig*, $C_{\text{SRS}} \in \{0, 1, 2, 3, 4, 5, 6, 7\}$ and the UE-specific parameter *srs-Bandwidth*, $B_{\text{SRS}} \in \{0, 1, 2, 3\}$ are given by higher layers. For UpPTS, $m_{\text{SRS}, 0}$ shall be reconfigured to $m_{\text{SRS}, 0}^{\text{max}} = \max_{c \in C_{\text{SRS}}} \{m_{\text{SRS}, 0}^c\} \leq (N_{\text{RB}}^{\text{UL}} - 6N_{\text{RA}})$ if this reconfiguration is enabled by the cell-specific parameter *srsMaxUpPts* given by higher layers, otherwise if the reconfiguration is disabled $m_{\text{SRS}, 0}^{\text{max}} = m_{\text{SRS}, c}$ where c is a SRS BW configuration and C_{SRS} is the set of SRS BW configurations from the Tables 5.5.3.2-1 to 5.5.3.2-4 for each uplink bandwidth $N_{\text{RB}}^{\text{UL}}$, N_{RA} is the number of format 4 PRACH in the addressed UpPTS and derived from Table 5.7.1-4.

The frequency-domain starting position $k_0^{(p)}$ is defined by

$$k_0^{(p)} = \bar{k}_0^{(p)} + \sum_{b=0}^{B_{\text{SRS}}} K_{\text{TC}} M_{\text{sc}, b}^{\text{RS}} n_b$$

where for normal uplink subframes $\bar{k}_0^{(p)}$ is defined by

$$\bar{k}_0^{(p)} = \left\lfloor N_{\text{RB}}^{\text{UL}} / 2 \right\rfloor - m_{\text{SRS}, 0} / 2 \Big) N_{\text{sc}}^{\text{RB}} + k_{\text{TC}}^{(p)}$$

and for UpPTS by

$$\bar{k}_0^{(p)} = \begin{cases} (N_{\text{RB}}^{\text{UL}} - m_{\text{SRS}, 0}^{\text{max}}) N_{\text{sc}}^{\text{RB}} + k_{\text{TC}}^{(p)} & \text{if } ((n_f \bmod 2) \cdot (2 - N_{\text{SP}}) + n_{\text{hf}}) \bmod 2 = 0 \\ k_{\text{TC}}^{(p)} & \text{otherwise} \end{cases}$$

The quantity $k_{\text{TC}}^{(p)} \in \{0, 1, \dots, K_{\text{TC}} - 1\}$ is given by

$$k_{\text{TC}}^{(p)} = \begin{cases} 1 - \bar{k}_{\text{TC}} & \text{if } n_{\text{SRS}}^{\text{cs}} \in \{4, 5, 6, 7\} \text{ and } \tilde{p} \in \{1, 3\} \text{ and } N_{\text{ap}} = 4 \\ \bar{k}_{\text{TC}} & \text{otherwise} \end{cases}$$

where the relation between the index \tilde{p} and the antenna port p is given by Table 5.2.1-1, $\bar{k}_{\text{TC}} \in \{0, 1, \dots, K_{\text{TC}} - 1\}$ is given by the UE-specific parameter *transmissionComb* or *transmissionComb-ap* for periodic and each configuration of aperiodic transmission, respectively, provided by higher layers for the UE, and n_b is frequency position index. The

variable n_{hf} is equal to 0 for UpPTS in the first half frame and equal to 1 for UpPTS in the second half frame of a radio frame.

The frequency hopping of the sounding reference signal is configured by the parameter $b_{hop} \in \{0,1,2,3\}$, provided by higher-layer parameter *srs-HoppingBandwidth*. Frequency hopping is not supported for aperiodic transmission, except for additional SRS. If frequency hopping of the sounding reference signal is not enabled (i.e., $b_{hop} \geq B_{SRS}$), the frequency position index n_b remains constant (unless re-configured) and is defined by $n_b = \lfloor 4n_{RRC}/m_{SRS,b} \rfloor \bmod N_b$ where the parameter n_{RRC} is given by higher-layer parameters *freqDomainPosition* and *freqDomainPosition-ap* for periodic and each configuration of aperiodic transmission, respectively. If frequency hopping of the sounding reference signal is enabled (i.e., $b_{hop} < B_{SRS}$), the frequency position indexes n_b are defined by

$$n_b = \begin{cases} \lfloor 4n_{RRC}/m_{SRS,b} \rfloor \bmod N_b & b \leq b_{hop} \\ \{F_b(n_{SRS}) + \lfloor 4n_{RRC}/m_{SRS,b} \rfloor\} \bmod N_b & \text{otherwise} \end{cases}$$

where N_b is given by Table 5.5.3.2-1 through Table 5.5.3.2-4 for each uplink bandwidth N_{RB}^{UL} ,

$$F_b(n_{SRS}) = \begin{cases} (N_b/2) \left\lfloor \frac{n_{SRS} \bmod \Pi_{b'=b_{hop}}^b N_{b'}}{\Pi_{b'=b_{hop}}^{b-1} N_{b'}} \right\rfloor + \left\lfloor \frac{n_{SRS} \bmod \Pi_{b'=b_{hop}}^b N_{b'}}{2\Pi_{b'=b_{hop}}^{b-1} N_{b'}} \right\rfloor & \text{if } N_b \text{ even} \\ \lfloor N_b/2 \rfloor \lfloor n_{SRS} / \Pi_{b'=b_{hop}}^{b-1} N_{b'} \rfloor & \text{if } N_b \text{ odd} \end{cases}$$

where $N_{b_{hop}} = 1$ regardless of the N_b value on Table 5.5.3.2-1 through Table 5.5.3.2-4, and

$$n_{SRS} = \begin{cases} \left\lfloor 2N_{SP}n_f + 2(N_{SP}-1) \left\lfloor \frac{n_s}{10} \right\rfloor + \left\lfloor \frac{T_{offset}}{T_{offset_max}} \right\rfloor \right\rfloor, & \text{for 2 ms SRS periodicity of frame structure type 2} \\ \lfloor (n_f \times 10 + \lfloor n_s/2 \rfloor) / T_{SRS} \rfloor, & \text{otherwise} \end{cases}$$

counts the number of UE-specific SRS transmissions, where T_{SRS} is UE-specific periodicity of SRS transmission defined in clause 8.2 of 3GPP TS 36.213 [4], T_{offset} is SRS subframe offset defined in Table 8.2-2 of 3GPP TS 36.213 [4] and T_{offset_max} is the maximum value of T_{offset} for a certain configuration of SRS subframe offset.

The sounding reference signal shall be transmitted in the last symbol of the uplink subframe.

Table 5.5.3.2-1: $m_{SRS,b}$ and N_b , $b = 0,1,2,3$, values for the uplink bandwidth of $6 \leq N_{RB}^{UL} \leq 40$

SRS bandwidth configuration C_{SRS}	SRS-Bandwidth $B_{SRS} = 0$		SRS-Bandwidth $B_{SRS} = 1$		SRS-Bandwidth $B_{SRS} = 2$		SRS-Bandwidth $B_{SRS} = 3$	
	$m_{SRS,0}$	N_0	$m_{SRS,1}$	N_1	$m_{SRS,2}$	N_2	$m_{SRS,3}$	N_3
0	36	1	12	3	4	3	4	1
1	32	1	16	2	8	2	4	2
2	24	1	4	6	4	1	4	1
3	20	1	4	5	4	1	4	1
4	16	1	4	4	4	1	4	1
5	12	1	4	3	4	1	4	1
6	8	1	4	2	4	1	4	1
7	4	1	4	1	4	1	4	1

Table 5.5.3.2-2: $m_{\text{SRS},b}$ and N_b , $b=0,1,2,3$, values for the uplink bandwidth of $40 < N_{\text{RB}}^{\text{UL}} \leq 60$

SRS bandwidth configuration C_{SRS}	SRS-Bandwidth $B_{\text{SRS}} = 0$		SRS-Bandwidth $B_{\text{SRS}} = 1$		SRS-Bandwidth $B_{\text{SRS}} = 2$		SRS-Bandwidth $B_{\text{SRS}} = 3$	
	$m_{\text{SRS},0}$	N_0	$m_{\text{SRS},1}$	N_1	$m_{\text{SRS},2}$	N_2	$m_{\text{SRS},3}$	N_3
0	48	1	24	2	12	2	4	3
1	48	1	16	3	8	2	4	2
2	40	1	20	2	4	5	4	1
3	36	1	12	3	4	3	4	1
4	32	1	16	2	8	2	4	2
5	24	1	4	6	4	1	4	1
6	20	1	4	5	4	1	4	1
7	16	1	4	4	4	1	4	1

Table 5.5.3.2-3: $m_{\text{SRS},b}$ and N_b , $b=0,1,2,3$, values for the uplink bandwidth of $60 < N_{\text{RB}}^{\text{UL}} \leq 80$

SRS bandwidth configuration C_{SRS}	SRS-Bandwidth $B_{\text{SRS}} = 0$		SRS-Bandwidth $B_{\text{SRS}} = 1$		SRS-Bandwidth $B_{\text{SRS}} = 2$		SRS-Bandwidth $B_{\text{SRS}} = 3$	
	$m_{\text{SRS},0}$	N_0	$m_{\text{SRS},1}$	N_1	$m_{\text{SRS},2}$	N_2	$m_{\text{SRS},3}$	N_3
0	72	1	24	3	12	2	4	3
1	64	1	32	2	16	2	4	4
2	60	1	20	3	4	5	4	1
3	48	1	24	2	12	2	4	3
4	48	1	16	3	8	2	4	2
5	40	1	20	2	4	5	4	1
6	36	1	12	3	4	3	4	1
7	32	1	16	2	8	2	4	2

Table 5.5.3.2-4: $m_{\text{SRS},b}$ and N_b , $b=0,1,2,3$, values for the uplink bandwidth of $80 < N_{\text{RB}}^{\text{UL}} \leq 110$

SRS bandwidth configuration C_{SRS}	SRS-Bandwidth $B_{\text{SRS}} = 0$		SRS-Bandwidth $B_{\text{SRS}} = 1$		SRS-Bandwidth $B_{\text{SRS}} = 2$		SRS-Bandwidth $B_{\text{SRS}} = 3$	
	$m_{\text{SRS},0}$	N_0	$m_{\text{SRS},1}$	N_1	$m_{\text{SRS},2}$	N_2	$m_{\text{SRS},3}$	N_3
0	96	1	48	2	24	2	4	6
1	96	1	32	3	16	2	4	4
2	80	1	40	2	20	2	4	5
3	72	1	24	3	12	2	4	3
4	64	1	32	2	16	2	4	4
5	60	1	20	3	4	5	4	1
6	48	1	24	2	12	2	4	3
7	48	1	16	3	8	2	4	2

5.5.3.2.2 Mapping to physical resources for additional SRS

An additional SRS spans one or more OFDM symbols in the time domain, where

- the starting OFDM symbol l_0 within the subframe is given by the higher-layer parameter *additionalSRS-startPos*;
- the duration N in number of OFDM symbols, including potential guard symbols, is given by the higher-layer parameter *additionalSRS-duration*;

Mapping to physical resources shall be done according to clause 5.5.3.2.1 with the following exceptions:

- frequency hopping between OFDM symbols is supported and if a UE is configured by higher layer parameter *additionalSRS-GuardSymbolFH*, a guard symbol is added between every frequency hop;

- antenna switching within a subframe is supported and if a UE is configured by higher layer parameter *additionalSRS-GuardSymbolAS*, a guard symbol is added between every antenna switching;
- $n_{\text{SRS}} = \lfloor l'/R \rfloor$ where l' is the additional SRS transmission number not counting guard symbol(s) within the subframe with $l' = 0$ corresponding to the starting OFDM symbol l_0 , and $R \in \{1,2,3,4,6,7,8,9,12,13\}$ is the repetition factor given by the higher-layer parameter *additionalSRS-RepNum*;
- B_{SRS} is given by the higher-layer parameter *additionalSRS-Bandwidth*;
- b_{hop} is given by the higher-layer parameter *additionalSRS-HoppingBandwidth*;
- N_{FH} is the number of frequency hops with the same antenna/antenna pair for additional SRS, derived from $N = RN_{\text{FH}} + (N_{\text{FH}} - 1)G_{\text{FH}}$ if antenna switching is not configured for additional SRS, and from $N = RN_{\text{AS}}N_{\text{FH}} + (N_{\text{AS}} - 1)G_{\text{AS}} + (N_{\text{FH}} - 1)N_{\text{AS}}G_{\text{FH}} + (N_{\text{AS}} - 1)(1 - G_{\text{AS}})G_{\text{FH}}$ if antenna switching is configured for additional SRS, where R is the repetition factor given by the higher-layer parameter *additionalSRS-RepNum*, N_{AS} is the number of antenna switches for additional SRS defined in 8.2 of [4], $G_{\text{AS}} \in \{0, 1\}$ is the guard-symbol configuration for antenna switching given by the higher-layer parameter *additionalSRS-GuardSymbolAS*, $G_{\text{FH}} \in \{0, 1\}$ is the guard symbol configuration for frequency hopping given by the higher-layer parameter *additionalSRS-GuardSymbolFH*, and N is given by the higher-layer parameter *additionalSRS-duration*;
- n_{RRC} is given by the higher-layer parameter *freqDomainPosition-additionalSRS*;
- N_{ap} is given by the higher-layer parameter *additionalSRS-AntennaPort*;
- $n_{\text{SRS}}^{\text{cs}}$ is given by the higher-layer parameter *additionalSRS-cyclicShift*;
- K_{TC} is given by the higher-layer parameter *additionalSRS-transmissionCombNum*;
- \bar{k}_{TC} is given by the higher-layer parameter *additionalSRS-transmissionComb*.

5.5.3.3 Sounding reference signal subframe configuration

The cell-specific subframe configuration period T_{SFC} and the cell-specific subframe offset Δ_{SFC} for the transmission of sounding reference signals are listed in Tables 5.5.3.3-1 and 5.5.3.3-2, for frame structures type 1 and 2 respectively, where the parameter *srs-SubframeConfig* is provided by higher layers. Sounding reference signal subframes are the subframes satisfying $\lfloor n_s / 2 \rfloor \bmod T_{\text{SFC}} \in \Delta_{\text{SFC}}$. For frame structure type 2, a sounding reference signal is transmitted only in uplink subframes or UpPTS.

Table 5.5.3.3-1: Frame structure type 1 sounding reference signal subframe configuration

srs-SubframeConfig	Binary	Configuration Period T_{SFC} (subframes)	Transmission offset Δ_{SFC} (subframes)
0	0000	1	{0}
1	0001	2	{0}
2	0010	2	{1}
3	0011	5	{0}
4	0100	5	{1}
5	0101	5	{2}
6	0110	5	{3}
7	0111	5	{0,1}
8	1000	5	{2,3}
9	1001	10	{0}
10	1010	10	{1}
11	1011	10	{2}
12	1100	10	{3}
13	1101	10	{0,1,2,3,4,6,8}
14	1110	10	{0,1,2,3,4,5,6,8}
15	1111	reserved	reserved

Table 5.5.3.3-2: Frame structure type 2 sounding reference signal subframe configuration

srs-SubframeConfig	Binary	Configuration Period T_{SFC} (subframes)	Transmission offset Δ_{SFC} (subframes)
0	0000	5	{1}
1	0001	5	{1, 2}
2	0010	5	{1, 3}
3	0011	5	{1, 4}
4	0100	5	{1, 2, 3}
5	0101	5	{1, 2, 4}
6	0110	5	{1, 3, 4}
7	0111	5	{1, 2, 3, 4}
8	1000	10	{1, 2, 6}
9	1001	10	{1, 3, 6}
10	1010	10	{1, 6, 7}
11	1011	10	{1, 2, 6, 8}
12	1100	10	{1, 3, 6, 9}
13	1101	10	{1, 4, 6, 7}
14	1110	reserved	reserved
15	1111	reserved	reserved

5.6 SC-FDMA baseband signal generation

This clause applies to all uplink physical signals and uplink physical channels except the physical random access channel and PUSCH using sub-PRB allocations for BL/CE UEs.

The time-continuous signal $s_l^{(p)}(t)$ for antenna port p in SC-FDMA symbol l in an uplink slot is defined by

$$s_l^{(p)}(t) = \sum_{k=-\lfloor N_{RB}^{UL} N_{sc}^{RB} / 2 \rfloor}^{\lfloor N_{RB}^{UL} N_{sc}^{RB} / 2 \rfloor - 1} a_{k^{(-)},l}^{(p)} \cdot e^{j2\pi(k+1/2)\Delta f(t - N_{CP,l}T_s)}$$

for $0 \leq t < (N_{CP,l} + N) \times T_s$ where $k^{(-)} = k + \lfloor N_{RB}^{UL} N_{sc}^{RB} / 2 \rfloor$, $N = 2048$, $\Delta f = 15$ kHz and $a_{k,l}^{(p)}$ is the content of resource element (k, l) on antenna port p .

For frame structure type 3, if the associated DCI indicates PUSCH starting position other than '00' or if 'autonomous PUSCH' is configured, $s_l^{(p)}(t), l=0$ is given by

$$s_0^{(p)}(t) = \begin{cases} 0 & 0 \leq t < N_{start}^{FS3} T_s \\ -s_1^{(p)}(t - N_{CP,0} T_s) & N_{start}^{FS3} T_s \leq t < (N_{CP,0} + N) T_s \end{cases}$$

where

$$N_{start}^{FS3} = \begin{cases} 768 & \text{if the associated DCI indicates PUSCH starting position '01'} \\ 768 + N_{TA} & \text{if the associated DCI indicates PUSCH starting position '10'} \\ N_{CP,0} + N & \text{if the associated DCI indicates PUSCH starting position '11'} \end{cases}$$

and were N_{start}^{FS3} is given by TS36.213 [4] if 'autonomous PUSCH' is configured.

The quantity N_{TA} is given by clause 8.1. The UE behaviour if $N_{start}^{FS3} > N_{CP,0} + N$ is undefined.

The SC-FDMA symbols in a slot shall be transmitted in increasing order of l , starting with $l=0$, where SC-FDMA symbol $l > 0$ starts at time $\sum_{l'=0}^{l-1} (N_{CP,l'} + N) T_s$ within the slot.

Table 5.6-1 lists the values of $N_{CP,l}$ that shall be used.

Table 5.6-1: SC-FDMA parameters

Configuration	Cyclic prefix length $N_{CP,l}$
Normal cyclic prefix	160 for $l=0$ 144 for $l=1,2,\dots,6$
Extended cyclic prefix	512 for $l=0,1,\dots,5$

5.6A SC-FDMA baseband signal generation for PUSCH using sub-PRB allocations

5.6A.1 Modulation schemes other than $\pi/2$ -BPSK

For $M_{sc}^{RU} > 1$, the time-continuous signal $s_l^{(p)}(t)$ for antenna port p in SC-FDMA symbol l in an uplink slot is defined by clause 5.6 with $N_{RB}^{UL}N_{sc}^{RB}$ replaced by M_{sc}^{UL} .

5.6A.2 Modulation scheme $\pi/2$ -BPSK

For $M_{sc}^{RU} = 3$ and $\pi/2$ -BPSK modulation only 2-of-3 adjacent subcarriers are selected as described in 5.5.2.1A.2. The time-continuous signal $s_{k,l}(t)$ in SC-FDMA symbol l in an uplink slot is defined by

$$\begin{aligned} s_{k,l}(t) &= s_{sc1}(t) + s_{sc2}(t) \\ s_{sc1}(t) &= a_{k^{(-)},l} e^{j\phi_{k,l}} e^{j2\pi(k+1/2)\Delta f(t-N_{CP,l}T_s)} \\ s_{sc2}(t) &= a_{k^{(-)+1,l} } e^{j\phi_{k,l}} e^{j2\pi(k+3/2)\Delta f(t-N_{CP,l}T_s)} \\ k^{(-)} &= k + \lfloor M_{sc}^{UL}/2 \rfloor \end{aligned}$$

for $0 \leq t < (N_{CP,l} + N)T_s$ where $N = 2048$, $\Delta f = 15$ kHz, $N_{CP,l}$ is given by Table 5.6-1, and $a_{k^{(-)},l}$ and $a_{k^{(-)+1,l}$ are respectively the modulation value for subcarrier index $k^{(-)}$ and $k^{(-)} + 1$ for symbol l , and the values of k used on $s_{sc1}(t)$ and $s_{sc2}(t)$ are respectively obtained by subtracting $\lfloor M_{sc}^{UL}/2 \rfloor$ from the resulting set of allocated subcarriers as described in Table 8.1.6-1 of [4], and $k^{(-)}$ represents the lower subcarrier index among the selected subcarriers and $k^{(-)} + 1$ is the subcarrier index adjacent to it. The phase rotation ϕ is given by

$$\begin{aligned} \phi &= \frac{\pi}{2}(\tilde{l} \bmod 2) + \varphi_{avg_k}(\tilde{l}) \\ \varphi_{avg_k}(\tilde{l}) &= \varphi_{avg_k}(\tilde{l} - 1) + 2\pi\Delta f(k + 1)(N + N_{CP,l})T_s \text{ when } \tilde{l} > 0 \\ \varphi_{avg_k}(0) &= 0 \\ \tilde{l} &= 0, 1, \dots, N_{TB}N_{rep}^{PUSCH}M_{RU}M_{slots}^{UL}M_{symb}^{UL} - 1 \\ l &= \tilde{l} \bmod M_{symb}^{UL} \end{aligned}$$

where N_{TB} is the number of transport blocks defined in clause 8.0 of 3GPP TS 36.213 [4]. If $N_{TB} > 1$ and interleaving between codewords is applied according to clause 8.0 of 3GPP TS 36.213 [4], then the symbol counter \tilde{l} is reset at the start of the first PUSCH codeword transmission and incremented for each symbol during the transmission of the N_{TB} PUSCH codewords. For other cases, the symbol counter \tilde{l} is reset at the start of each PUSCH codeword transmission and incremented for each symbol during the transmission of the PUSCH codeword.

The SC-FDMA symbols in a slot shall be transmitted in increasing order of l , starting with $l = 0$, where SC-FDMA symbol $l > 0$ starts at time $\sum_{l'=0}^{l-1} (N_{CP,l'} + N)T_s$ within the slot.

5.7 Physical random access channel

5.7.1 Time and frequency structure

The physical layer random access preamble, illustrated in Figure 5.7.1-1, consists of a cyclic prefix of length T_{CP} and a sequence part of length T_{SEQ} . The parameter values are listed in Table 5.7.1-1 and depend on the frame structure and the random access configuration. Higher layers control the preamble format.

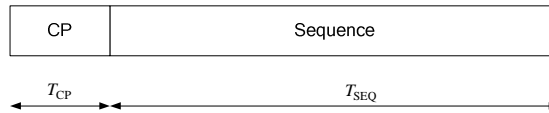

Figure 5.7.1-1: Random access preamble format

Table 5.7.1-1: Random access preamble parameters

Preamble format	T_{CP}	T_{SEQ}
0	$3168 \cdot T_s$	$24576 \cdot T_s$
1	$21024 \cdot T_s$	$24576 \cdot T_s$
2	$6240 \cdot T_s$	$2 \cdot 24576 \cdot T_s$
3	$21024 \cdot T_s$	$2 \cdot 24576 \cdot T_s$
4 (see Note)	$448 \cdot T_s$	$4096 \cdot T_s$

NOTE: Frame structure type 2 and special subframe configurations with UpPTS lengths $4384 \cdot T_s$ and $5120 \cdot T_s$ only assuming that the number of additional SC-FDMA symbols in UpPTS X in Table 4.2-1 is 0.

The transmission of a random access preamble, if triggered by the MAC layer, is restricted to certain time and frequency resources. These resources are enumerated in increasing order of the subframe number within the radio frame and the physical resource blocks in the frequency domain such that index 0 correspond to the lowest numbered physical resource block and subframe within the radio frame. PRACH resources within the radio frame are indicated by a PRACH configuration index, where the indexing is in the order of appearance in Table 5.7.1-2 and Table 5.7.1-4.

For non-BL/CE UEs there are up to two PRACH configurations in a cell. The first PRACH configuration is configured by higher layers with a PRACH configuration index (*prach-ConfigurationIndex*) and a PRACH frequency offset $n_{PRB\ offset}^{RA}$ (*prach-FrequencyOffset*). The second PRACH configuration (if any) is configured by higher layers with a PRACH configuration index (*prach-ConfigurationIndexHighSpeed*) and a PRACH frequency offset $n_{PRB\ offset}^{RA}$ (*prach-FrequencyOffsetHighSpeed*).

For BL/CE UEs, for each PRACH coverage enhancement level, there is a PRACH configuration configured by higher layers with a PRACH configuration index (*prach-ConfigurationIndex*), a PRACH frequency offset $n_{PRB\ offset}^{RA}$ (*prach-FrequencyOffset*), a number of PRACH repetitions per attempt N_{rep}^{PRACH} (*numRepetitionPerPreambleAttempt*) and optionally a PRACH starting subframe periodicity N_{start}^{PRACH} (*prach-StartingSubframe*). PRACH of preamble format 0-3 is transmitted $N_{rep}^{PRACH} \geq 1$ times, whereas PRACH of preamble format 4 is transmitted one time only.

For BL/CE UEs and for each PRACH coverage enhancement level, if frequency hopping is enabled for a PRACH configuration by the higher-layer parameter *prach-HoppingConfig*, the value of the parameter $n_{PRB\ offset}^{RA}$ depends on the SFN and the PRACH configuration index and is given by

- In case the PRACH configuration index is such that a PRACH resource occurs in every radio frame when calculated as below from Table 5.7.1-2 or Table 5.7.1-4,

$$n_{PRB\ offset}^{RA} = \begin{cases} n_{PRB\ offset}^{RA} & \text{if } n_f \bmod 2 = 0 \\ \left(n_{PRB\ offset}^{RA} + f_{PRB, hop}^{PRACH} \right) \bmod N_{RB}^{UL} & \text{if } n_f \bmod 2 = 1 \end{cases}$$

- otherwise

$$n_{\text{PRB offset}}^{\text{RA}} = \begin{cases} \bar{n}_{\text{PRB offset}}^{\text{RA}} & \text{if } \left\lfloor \frac{n_f \bmod 4}{2} \right\rfloor = 0 \\ \left(\bar{n}_{\text{PRB offset}}^{\text{RA}} + f_{\text{PRB,hop}}^{\text{PRACH}} \right) \bmod N_{\text{RB}}^{\text{UL}} & \text{if } \left\lfloor \frac{n_f \bmod 4}{2} \right\rfloor = 1 \end{cases}$$

where n_f is the system frame number corresponding to the first subframe for each PRACH repetition, $f_{\text{PRB,hop}}^{\text{PRACH}}$ corresponds to a cell-specific higher-layer parameter *prach-HoppingOffset*. If frequency hopping is not enabled for the PRACH configuration then $n_{\text{PRB offset}}^{\text{RA}} = \bar{n}_{\text{PRB offset}}^{\text{RA}}$.

For frame structure type 1 with preamble format 0-3, for each of the PRACH configurations there is at most one random access resource per subframe.

Table 5.7.1-2 lists the preamble formats according to Table 5.7.1-1 and the subframes in which random access preamble transmission is allowed for a given configuration in frame structure type 1. The start of the random access preamble shall be aligned with the start of the corresponding uplink subframe at the UE assuming $N_{\text{TA}} = 0$, where N_{TA} is defined in clause 8.1. For PRACH configurations 0, 1, 2, 15, 16, 17, 18, 31, 32, 33, 34, 47, 48, 49, 50 and 63 the UE may for handover purposes assume an absolute value of the relative time difference between radio frame i in the current cell and the target cell of less than $153600 \cdot T_s$.

The first physical resource block $n_{\text{PRB}}^{\text{RA}}$ allocated to the PRACH opportunity considered for preamble formats 0, 1, 2 and 3 is defined as $n_{\text{PRB}}^{\text{RA}} = n_{\text{PRB offset}}^{\text{RA}}$.

Table 5.7.1-2: Frame structure type 1 random access configuration for preamble formats 0-3

PRACH Configuration Index	Preamble Format	System frame number	Subframe number	PRACH Configuration Index	Preamble Format	System frame number	Subframe number
0	0	Even	1	32	2	Even	1
1	0	Even	4	33	2	Even	4
2	0	Even	7	34	2	Even	7
3	0	Any	1	35	2	Any	1
4	0	Any	4	36	2	Any	4
5	0	Any	7	37	2	Any	7
6	0	Any	1, 6	38	2	Any	1, 6
7	0	Any	2, 7	39	2	Any	2, 7
8	0	Any	3, 8	40	2	Any	3, 8
9	0	Any	1, 4, 7	41	2	Any	1, 4, 7
10	0	Any	2, 5, 8	42	2	Any	2, 5, 8
11	0	Any	3, 6, 9	43	2	Any	3, 6, 9
12	0	Any	0, 2, 4, 6, 8	44	2	Any	0, 2, 4, 6, 8
13	0	Any	1, 3, 5, 7, 9	45	2	Any	1, 3, 5, 7, 9
14	0	Any	0, 1, 2, 3, 4, 5, 6, 7, 8, 9	46	N/A	N/A	N/A
15	0	Even	9	47	2	Even	9
16	1	Even	1	48	3	Even	1
17	1	Even	4	49	3	Even	4
18	1	Even	7	50	3	Even	7
19	1	Any	1	51	3	Any	1
20	1	Any	4	52	3	Any	4
21	1	Any	7	53	3	Any	7
22	1	Any	1, 6	54	3	Any	1, 6
23	1	Any	2, 7	55	3	Any	2, 7
24	1	Any	3, 8	56	3	Any	3, 8
25	1	Any	1, 4, 7	57	3	Any	1, 4, 7
26	1	Any	2, 5, 8	58	3	Any	2, 5, 8
27	1	Any	3, 6, 9	59	3	Any	3, 6, 9
28	1	Any	0, 2, 4, 6, 8	60	N/A	N/A	N/A
29	1	Any	1, 3, 5, 7, 9	61	N/A	N/A	N/A
30	N/A	N/A	N/A	62	N/A	N/A	N/A
31	1	Even	9	63	3	Even	9

For frame structure type 2 with preamble formats 0-4, for each of the PRACH configurations there might be multiple random access resources in an UL subframe (or UpPTS for preamble format 4) depending on the UL/DL configuration [see table 4.2-2]. Table 5.7.1-3 lists PRACH configurations allowed for frame structure type 2 where the configuration index corresponds to a certain combination of preamble format, PRACH density value, D_{RA} and version index, r_{RA} . For frame structure type 2 with PRACH configuration indices 0, 1, 2, 20, 21, 22, 30, 31, 32, 40, 41, 42, 48, 49, 50, or with PRACH configuration indices 51, 53, 54, 55, 56, 57 in UL/DL configuration 3, 4, 5, the UE may for handover purposes assume an absolute value of the relative time difference between radio frame i in the current cell and the target cell is less than $153600 \cdot T_s$.

Table 5.7.1-3: Frame structure type 2 random access configurations for preamble formats 0-4

PRACH configuration Index	Preamble Format	Density Per 10 ms D_{RA}	Version r_{RA}	PRACH configuration Index	Preamble Format	Density Per 10 ms D_{RA}	Version r_{RA}
0	0	0.5	0	32	2	0.5	2
1	0	0.5	1	33	2	1	0
2	0	0.5	2	34	2	1	1
3	0	1	0	35	2	2	0
4	0	1	1	36	2	3	0
5	0	1	2	37	2	4	0
6	0	2	0	38	2	5	0
7	0	2	1	39	2	6	0
8	0	2	2	40	3	0.5	0
9	0	3	0	41	3	0.5	1
10	0	3	1	42	3	0.5	2
11	0	3	2	43	3	1	0
12	0	4	0	44	3	1	1
13	0	4	1	45	3	2	0
14	0	4	2	46	3	3	0
15	0	5	0	47	3	4	0
16	0	5	1	48	4	0.5	0
17	0	5	2	49	4	0.5	1
18	0	6	0	50	4	0.5	2
19	0	6	1	51	4	1	0
20	1	0.5	0	52	4	1	1
21	1	0.5	1	53	4	2	0
22	1	0.5	2	54	4	3	0
23	1	1	0	55	4	4	0
24	1	1	1	56	4	5	0
25	1	2	0	57	4	6	0
26	1	3	0	58	N/A	N/A	N/A
27	1	4	0	59	N/A	N/A	N/A
28	1	5	0	60	N/A	N/A	N/A
29	1	6	0	61	N/A	N/A	N/A
30	2	0.5	0	62	N/A	N/A	N/A
31	2	0.5	1	63	N/A	N/A	N/A

Table 5.7.1-4 lists the mapping to physical resources for the different random access opportunities needed for a certain PRACH density value, D_{RA} . Each quadruple of the format $(f_{RA}, t_{RA}^{(0)}, t_{RA}^{(1)}, t_{RA}^{(2)})$ indicates the location of a specific random access resource, where f_{RA} is a frequency resource index within the considered time instance, $t_{RA}^{(0)} = 0,1,2$ indicates whether the resource is reoccurring in all radio frames, in even radio frames, or in odd radio frames, respectively, $t_{RA}^{(1)} = 0,1$ indicates whether the random access resource is located in first half frame or in second half frame, respectively, and where $t_{RA}^{(2)}$ is the uplink subframe number where the preamble starts, counting from 0 at the first uplink subframe between 2 consecutive downlink-to-uplink switch points, with the exception of preamble format 4 where $t_{RA}^{(2)}$ is denoted as (*). The start of the random access preamble formats 0-3 shall be aligned with the start of the corresponding uplink subframe at the UE assuming $N_{TA} = 0$ and the random access preamble format 4 shall start $4832 \cdot T_s$ before the end of the UpPTS at the UE, where the UpPTS is referenced to the UE's uplink frame timing assuming $N_{TA} = 0$.

The random access opportunities for each PRACH configuration shall be allocated in time first and then in frequency if and only if time multiplexing is not sufficient to hold all opportunities of a PRACH configuration needed for a certain density value D_{RA} without overlap in time. For preamble format 0-3, the frequency multiplexing shall be done according to

$$n_{PRB}^{RA} = \begin{cases} n_{PRB\ offset}^{RA} + 6 \left\lfloor \frac{f_{RA}}{2} \right\rfloor, & \text{if } f_{RA} \bmod 2 = 0 \\ N_{RB}^{UL} - 6 - n_{PRB\ offset}^{RA} - 6 \left\lfloor \frac{f_{RA}}{2} \right\rfloor, & \text{otherwise} \end{cases}$$

where N_{RB}^{UL} is the number of uplink resource blocks, n_{PRB}^{RA} is the first physical resource block allocated to the PRACH opportunity considered and where $n_{PRB\ offset}^{RA}$ is the first physical resource block available for PRACH.

For preamble format 4, the frequency multiplexing shall be done according to

$$n_{PRB}^{RA} = \begin{cases} 6f_{RA}, & \text{if } ((n_f \bmod 2) \times (2 - N_{SP}) + t_{RA}^{(1)}) \bmod 2 = 0 \\ N_{RB}^{UL} - 6(f_{RA} + 1), & \text{otherwise} \end{cases}$$

where n_f is the system frame number and where N_{SP} is the number of DL to UL switch points within the radio frame.

For BL/CE UEs, only a subset of the subframes allowed for preamble transmission are allowed as starting subframes for the N_{rep}^{PRACH} repetitions. The allowed starting subframes for a PRACH configuration are determined as follows:

- Enumerate the subframes that are allowed for preamble transmission for the PRACH configuration as $n_{sf}^{RA} = 0, \dots, N_{sf}^{RA} - 1$ where $n_{sf}^{RA} = 0$ and $n_{sf}^{RA} = N_{sf}^{RA} - 1$ correspond to the two subframes allowed for preamble transmission with the smallest and the largest absolute subframe number n_{sf}^{abs} , respectively.
- If a PRACH starting subframe periodicity N_{start}^{PRACH} is not provided by higher layers, the periodicity of the allowed starting subframes in terms of subframes allowed for preamble transmission is N_{rep}^{PRACH} . The allowed starting subframes defined over $n_{sf}^{RA} = 0, \dots, N_{sf}^{RA} - 1$ are given by jN_{rep}^{PRACH} where $j = 0, 1, 2, \dots$
- If a PRACH starting subframe periodicity N_{start}^{PRACH} is provided by higher layers, it indicates the periodicity of the allowed starting subframes in terms of subframes allowed for preamble transmission. The allowed starting subframes defined over $n_{sf}^{RA} = 0, \dots, N_{sf}^{RA} - 1$ are given by $jN_{start}^{PRACH} + N_{rep}^{PRACH}$ where $j = 0, 1, 2, \dots$
- No starting subframe defined over $n_{sf}^{RA} = 0, \dots, N_{sf}^{RA} - 1$ such that $n_{sf}^{RA} > N_{sf}^{RA} - N_{rep}^{PRACH}$ is allowed.

Each random access preamble occupies a bandwidth corresponding to 6 consecutive resource blocks for both frame structures.

Table 5.7.1-4: Frame structure type 2 random access preamble mapping in time and frequency

PRACH configuration Index (See Table 5.7.1-3)	UL/DL configuration (See Table 4.2-2)						
	0	1	2	3	4	5	6
0	(0,1,0,2)	(0,1,0,1)	(0,1,0,0)	(0,1,0,2)	(0,1,0,1)	(0,1,0,0)	(0,1,0,2)
1	(0,2,0,2)	(0,2,0,1)	(0,2,0,0)	(0,2,0,2)	(0,2,0,1)	(0,2,0,0)	(0,2,0,2)
2	(0,1,1,2)	(0,1,1,1)	(0,1,1,0)	(0,1,0,1)	(0,1,0,0)	N/A	(0,1,1,1)
3	(0,0,0,2)	(0,0,0,1)	(0,0,0,0)	(0,0,0,2)	(0,0,0,1)	(0,0,0,0)	(0,0,0,2)
4	(0,0,1,2)	(0,0,1,1)	(0,0,1,0)	(0,0,0,1)	(0,0,0,0)	N/A	(0,0,1,1)
5	(0,0,0,1)	(0,0,0,0)	N/A	(0,0,0,0)	N/A	N/A	(0,0,0,1)
6	(0,0,0,2) (0,0,1,2)	(0,0,0,1) (0,0,1,1)	(0,0,0,0) (0,0,1,0)	(0,0,0,1) (0,0,0,2)	(0,0,0,0) (0,0,0,1)	(0,0,0,0) (1,0,0,0)	(0,0,0,2) (0,0,1,1)
7	(0,0,0,1) (0,0,1,1)	(0,0,0,0) (0,0,1,0)	N/A	(0,0,0,0) (0,0,0,2)	N/A	N/A	(0,0,0,1) (0,0,1,0)
8	(0,0,0,0) (0,0,1,0)	N/A	N/A	(0,0,0,0) (0,0,0,1)	N/A	N/A	(0,0,0,0) (0,0,1,1)
9	(0,0,0,1) (0,0,0,2) (0,0,1,2)	(0,0,0,0) (0,0,0,1) (0,0,1,1)	(0,0,0,0) (0,0,1,0) (1,0,0,0)	(0,0,0,0) (0,0,0,1) (0,0,0,2)	(0,0,0,0) (0,0,0,1) (1,0,0,1)	(0,0,0,0) (1,0,0,0) (2,0,0,0)	(0,0,0,1) (0,0,0,2) (0,0,1,1)
10	(0,0,0,0) (0,0,1,0) (0,0,1,1)	(0,0,0,1) (0,0,1,0) (0,0,1,1)	(0,0,0,0) (0,0,1,0) (1,0,1,0)	N/A	(0,0,0,0) (0,0,0,1) (1,0,0,0)	N/A	(0,0,0,0) (0,0,0,2) (0,0,1,0)
11	N/A	(0,0,0,0) (0,0,0,1) (0,0,1,0)	N/A	N/A	N/A	N/A	(0,0,0,1) (0,0,1,0) (0,0,1,1)
12	(0,0,0,1) (0,0,0,2) (0,0,1,1) (0,0,1,2)	(0,0,0,0) (0,0,0,1) (0,0,1,0) (0,0,1,1)	(0,0,0,0) (0,0,1,0) (1,0,0,0) (1,0,1,0)	(0,0,0,0) (0,0,0,1) (0,0,0,2) (1,0,0,2)	(0,0,0,0) (0,0,0,1) (1,0,0,0) (1,0,0,1)	(0,0,0,0) (1,0,0,0) (2,0,0,0) (3,0,0,0)	(0,0,0,1) (0,0,0,2) (0,0,1,0) (0,0,1,1)
13	(0,0,0,0) (0,0,0,2) (0,0,1,0) (0,0,1,2)	N/A	N/A	(0,0,0,0) (0,0,0,1) (0,0,0,2) (1,0,0,1)	N/A	N/A	(0,0,0,0) (0,0,0,1) (0,0,0,2) (0,0,1,1)
14	(0,0,0,0) (0,0,0,1) (0,0,1,0) (0,0,1,1)	N/A	N/A	(0,0,0,0) (0,0,0,1) (0,0,0,2) (1,0,0,0)	N/A	N/A	(0,0,0,0) (0,0,0,2) (0,0,1,0) (0,0,1,1)
15	(0,0,0,0) (0,0,0,1) (0,0,0,2) (0,0,1,1) (0,0,1,2)	(0,0,0,0) (0,0,0,1) (0,0,1,0) (0,0,1,1) (1,0,0,1)	(0,0,0,0) (0,0,1,0) (1,0,0,0) (1,0,1,0) (2,0,0,0)	(0,0,0,0) (0,0,0,1) (0,0,0,2) (1,0,0,1) (1,0,0,2)	(0,0,0,0) (0,0,0,1) (1,0,0,0) (1,0,0,1) (2,0,0,1)	(0,0,0,0) (1,0,0,0) (2,0,0,0) (3,0,0,0) (4,0,0,0)	(0,0,0,0) (0,0,0,1) (0,0,0,2) (0,0,1,0) (0,0,1,1)
16	(0,0,0,1) (0,0,0,2) (0,0,1,0) (0,0,1,1) (0,0,1,2)	(0,0,0,0) (0,0,0,1) (0,0,1,0) (0,0,1,1) (1,0,1,1)	(0,0,0,0) (0,0,1,0) (1,0,0,0) (1,0,1,0) (2,0,1,0)	(0,0,0,0) (0,0,0,1) (0,0,0,2) (1,0,0,0) (1,0,0,2)	(0,0,0,0) (0,0,0,1) (1,0,0,0) (1,0,0,1) (2,0,0,0)	N/A	N/A
17	(0,0,0,0) (0,0,0,1) (0,0,0,2) (0,0,1,0) (0,0,1,2)	(0,0,0,0) (0,0,0,1) (0,0,1,0) (0,0,1,1) (1,0,0,0)	N/A	(0,0,0,0) (0,0,0,1) (0,0,0,2) (1,0,0,0) (1,0,0,1)	N/A	N/A	N/A
18	(0,0,0,0) (0,0,0,1) (0,0,0,2) (0,0,1,0) (0,0,1,1) (0,0,1,2)	(0,0,0,0) (0,0,0,1) (0,0,1,0) (0,0,1,1) (1,0,0,1) (1,0,1,1)	(0,0,0,0) (0,0,1,0) (1,0,0,0) (1,0,1,0) (2,0,0,0) (2,0,1,0)	(0,0,0,0) (0,0,0,1) (0,0,0,2) (1,0,0,0) (1,0,0,1) (1,0,0,2)	(0,0,0,0) (0,0,0,1) (1,0,0,0) (1,0,0,1) (2,0,0,0) (2,0,0,1)	(0,0,0,0) (1,0,0,0) (2,0,0,0) (3,0,0,0) (4,0,0,0) (5,0,0,0)	(0,0,0,0) (0,0,0,1) (0,0,0,2) (0,0,1,0) (0,0,1,1) (1,0,0,2)
19	N/A	(0,0,0,0) (0,0,0,1) (0,0,1,0) (0,0,1,1) (1,0,0,0) (1,0,1,0)	N/A	N/A	N/A	N/A	(0,0,0,0) (0,0,0,1) (0,0,0,2) (0,0,1,0) (0,0,1,1) (1,0,1,1)
20 / 30	(0,1,0,1)	(0,1,0,0)	N/A	(0,1,0,1)	(0,1,0,0)	N/A	(0,1,0,1)
21 / 31	(0,2,0,1)	(0,2,0,0)	N/A	(0,2,0,1)	(0,2,0,0)	N/A	(0,2,0,1)
22 / 32	(0,1,1,1)	(0,1,1,0)	N/A	N/A	N/A	N/A	(0,1,1,0)
23 / 33	(0,0,0,1)	(0,0,0,0)	N/A	(0,0,0,1)	(0,0,0,0)	N/A	(0,0,0,1)
24 / 34	(0,0,1,1)	(0,0,1,0)	N/A	N/A	N/A	N/A	(0,0,1,0)
25 / 35	(0,0,0,1) (0,0,1,1)	(0,0,0,0) (0,0,1,0)	N/A	(0,0,0,1) (1,0,0,1)	(0,0,0,0) (1,0,0,0)	N/A	(0,0,0,1) (0,0,1,0)
26 / 36	(0,0,0,1) (0,0,1,1) (1,0,0,1)	(0,0,0,0) (0,0,1,0) (1,0,0,0)	N/A	(0,0,0,1) (1,0,0,1) (2,0,0,1)	(0,0,0,0) (1,0,0,0) (2,0,0,0)	N/A	(0,0,0,1) (0,0,1,0) (1,0,0,1)

27 / 37	(0,0,0,1) (0,0,1,1) (1,0,0,1) (1,0,1,1)	(0,0,0,0) (0,0,1,0) (1,0,0,0) (1,0,1,0)	N/A	(0,0,0,1) (1,0,0,1) (2,0,0,1) (3,0,0,1)	(0,0,0,0) (1,0,0,0) (2,0,0,0) (3,0,0,0)	N/A	(0,0,0,1) (0,0,1,0) (1,0,0,1) (1,0,1,0)
28 / 38	(0,0,0,1) (0,0,1,1) (1,0,0,1) (1,0,1,1) (2,0,0,1)	(0,0,0,0) (0,0,1,0) (1,0,0,0) (1,0,1,0) (2,0,0,0)	N/A	(0,0,0,1) (1,0,0,1) (2,0,0,1) (3,0,0,1) (4,0,0,1)	(0,0,0,0) (1,0,0,0) (2,0,0,0) (3,0,0,0) (4,0,0,0)	N/A	(0,0,0,1) (0,0,1,0) (1,0,0,1) (1,0,1,0) (2,0,0,1)
29/39	(0,0,0,1) (0,0,1,1) (1,0,0,1) (1,0,1,1) (2,0,0,1) (2,0,1,1)	(0,0,0,0) (0,0,1,0) (1,0,0,0) (1,0,1,0) (2,0,0,0) (2,0,1,0)	N/A	(0,0,0,1) (1,0,0,1) (2,0,0,1) (3,0,0,1) (4,0,0,1) (5,0,0,1)	(0,0,0,0) (1,0,0,0) (2,0,0,0) (3,0,0,0) (4,0,0,0) (5,0,0,0)	N/A	(0,0,0,1) (0,0,1,0) (1,0,0,1) (1,0,1,0) (2,0,0,1) (2,0,1,0)
40	(0,1,0,0)	N/A	N/A	(0,1,0,0)	N/A	N/A	(0,1,0,0)
41	(0,2,0,0)	N/A	N/A	(0,2,0,0)	N/A	N/A	(0,2,0,0)
42	(0,1,1,0)	N/A	N/A	N/A	N/A	N/A	N/A
43	(0,0,0,0)	N/A	N/A	(0,0,0,0)	N/A	N/A	(0,0,0,0)
44	(0,0,1,0)	N/A	N/A	N/A	N/A	N/A	N/A
45	(0,0,0,0) (0,0,1,0)	N/A	N/A	(0,0,0,0) (1,0,0,0)	N/A	N/A	(0,0,0,0) (1,0,0,0)
46	(0,0,0,0) (0,0,1,0) (1,0,0,0)	N/A	N/A	(0,0,0,0) (1,0,0,0) (2,0,0,0)	N/A	N/A	(0,0,0,0) (1,0,0,0) (2,0,0,0)
47	(0,0,0,0) (0,0,1,0) (1,0,0,0) (1,0,1,0)	N/A	N/A	(0,0,0,0) (1,0,0,0) (2,0,0,0) (3,0,0,0)	N/A	N/A	(0,0,0,0) (1,0,0,0) (2,0,0,0) (3,0,0,0)
48	(0,1,0,*)	(0,1,0,*)	(0,1,0,*)	(0,1,0,*)	(0,1,0,*)	(0,1,0,*)	(0,1,0,*)
49	(0,2,0,*)	(0,2,0,*)	(0,2,0,*)	(0,2,0,*)	(0,2,0,*)	(0,2,0,*)	(0,2,0,*)
50	(0,1,1,*)	(0,1,1,*)	(0,1,1,*)	N/A	N/A	N/A	(0,1,1,*)
51	(0,0,0,*)	(0,0,0,*)	(0,0,0,*)	(0,0,0,*)	(0,0,0,*)	(0,0,0,*)	(0,0,0,*)
52	(0,0,1,*)	(0,0,1,*)	(0,0,1,*)	N/A	N/A	N/A	(0,0,1,*)
53	(0,0,0,*) (0,0,1,*)	(0,0,0,*) (0,0,1,*)	(0,0,0,*) (0,0,1,*)	(0,0,0,*) (1,0,0,*)	(0,0,0,*) (1,0,0,*)	(0,0,0,*) (1,0,0,*)	(0,0,0,*) (0,0,1,*)
54	(0,0,0,*) (0,0,1,*) (1,0,0,*)	(0,0,0,*) (0,0,1,*) (1,0,0,*)	(0,0,0,*) (0,0,1,*) (1,0,0,*)	(0,0,0,*) (1,0,0,*) (2,0,0,*)	(0,0,0,*) (1,0,0,*) (2,0,0,*)	(0,0,0,*) (1,0,0,*) (2,0,0,*)	(0,0,0,*) (0,0,1,*) (1,0,0,*)
55	(0,0,0,*) (0,0,1,*) (1,0,0,*) (1,0,1,*)	(0,0,0,*) (0,0,1,*) (1,0,0,*) (1,0,1,*)	(0,0,0,*) (0,0,1,*) (1,0,0,*) (1,0,1,*)	(0,0,0,*) (1,0,0,*) (2,0,0,*) (3,0,0,*)	(0,0,0,*) (1,0,0,*) (2,0,0,*) (3,0,0,*)	(0,0,0,*) (1,0,0,*) (2,0,0,*) (3,0,0,*)	(0,0,0,*) (0,0,1,*) (1,0,0,*) (1,0,1,*)
56	(0,0,0,*) (0,0,1,*) (1,0,0,*) (1,0,1,*) (2,0,0,*)	(0,0,0,*) (0,0,1,*) (1,0,0,*) (1,0,1,*) (2,0,0,*)	(0,0,0,*) (0,0,1,*) (1,0,0,*) (1,0,1,*) (2,0,0,*)	(0,0,0,*) (1,0,0,*) (2,0,0,*) (3,0,0,*) (4,0,0,*)	(0,0,0,*) (1,0,0,*) (2,0,0,*) (3,0,0,*) (4,0,0,*)	(0,0,0,*) (1,0,0,*) (2,0,0,*) (3,0,0,*) (4,0,0,*)	(0,0,0,*) (0,0,1,*) (1,0,0,*) (1,0,1,*) (2,0,0,*)
57	(0,0,0,*) (0,0,1,*) (1,0,0,*) (1,0,1,*) (2,0,0,*) (2,0,1,*)	(0,0,0,*) (0,0,1,*) (1,0,0,*) (1,0,1,*) (2,0,0,*) (2,0,1,*)	(0,0,0,*) (0,0,1,*) (1,0,0,*) (1,0,1,*) (2,0,0,*) (2,0,1,*)	(0,0,0,*) (1,0,0,*) (2,0,0,*) (3,0,0,*) (4,0,0,*) (5,0,0,*)	(0,0,0,*) (1,0,0,*) (2,0,0,*) (3,0,0,*) (4,0,0,*) (5,0,0,*)	(0,0,0,*) (1,0,0,*) (2,0,0,*) (3,0,0,*) (4,0,0,*) (5,0,0,*)	(0,0,0,*) (0,0,1,*) (1,0,0,*) (1,0,1,*) (2,0,0,*) (2,0,1,*)
58	N/A	N/A	N/A	N/A	N/A	N/A	N/A
59	N/A	N/A	N/A	N/A	N/A	N/A	N/A
60	N/A	N/A	N/A	N/A	N/A	N/A	N/A
61	N/A	N/A	N/A	N/A	N/A	N/A	N/A
62	N/A	N/A	N/A	N/A	N/A	N/A	N/A
63	N/A	N/A	N/A	N/A	N/A	N/A	N/A

NOTE: * UpPTS

5.7.2 Preamble sequence generation

The random access preambles are generated from Zadoff-Chu sequences with zero correlation zone, generated from one or several root Zadoff-Chu sequences. The network configures the set of preamble sequences the UE is allowed to use.

There are up to two sets of 64 preambles available in a cell where Set 1 corresponds to higher layer PRACH configuration using *prach-ConfigurationIndex* and *prach-FrequencyOffset* and Set 2, if configured, corresponds to higher layer PRACH configuration using *prach-ConfigurationIndexHighSpeed* and *prach-FrequencyOffsetHighSpeed*. The set of 64 preamble sequences in a cell is found by including first, in the order of increasing cyclic shift, all the available cyclic shifts of a root Zadoff-Chu sequence with the logical index *rootSequenceIndexHighSpeed* (for Set 2, if configured) or with the logical index *RACH_ROOT_SEQUENCE* (for Set 1), where both *rootSequenceIndexHighSpeed* (if configured) and *RACH_ROOT_SEQUENCE* are broadcasted as part of the System Information. Additional preamble sequences, in case 64 preambles cannot be generated from a single root Zadoff-Chu sequence, are obtained from the root sequences with the consecutive logical indexes until all the 64 sequences are found.

The logical root sequence order is cyclic: the logical index 0 is consecutive to 837. The relation between a logical root sequence index and physical root sequence index u is given by Tables 5.7.2-4 and 5.7.2-5 for preamble formats 0 – 3 and 4, respectively.

The u^{th} root Zadoff-Chu sequence is defined by

$$x_u(n) = e^{-j \frac{\pi u n(n+1)}{N_{ZC}}}, \quad 0 \leq n \leq N_{ZC} - 1$$

where the length N_{ZC} of the Zadoff-Chu sequence is given by Table 5.7.2-1. From the u^{th} root Zadoff-Chu sequence, random access preambles with zero correlation zones of length $N_{CS} - 1$ are defined by cyclic shifts according to

$$x_{u,v}(n) = x_u((n + C_v) \bmod N_{ZC})$$

where the cyclic shift is given by

$$C_v = \begin{cases} vN_{CS} & v = 0, 1, \dots, \lfloor N_{ZC}/N_{CS} \rfloor - 1, N_{CS} \neq 0 & \text{for unrestricted sets} \\ 0 & N_{CS} = 0 & \text{for unrestricted sets} \\ \overline{d}_{\text{start}} \lfloor v/n_{\text{shift}}^{\text{RA}} \rfloor + (v \bmod n_{\text{shift}}^{\text{RA}})N_{CS} & v = 0, 1, \dots, w - 1 & \text{for restricted sets type A and B} \\ \overline{d}_{\text{start}} + (v - w)N_{CS} & v = w, \dots, w + \overline{n}_{\text{shift}}^{\text{RA}} - 1 & \text{for restricted sets type B} \\ \overline{d}_{\text{start}} + (v - w - \overline{n}_{\text{shift}}^{\text{RA}})N_{CS} & v = w + \overline{n}_{\text{shift}}^{\text{RA}}, \dots, w + \overline{n}_{\text{shift}}^{\text{RA}} + \overline{n}_{\text{shift}}^{\text{RA}} - 1 & \text{for restricted sets type B} \end{cases}$$

$$w = n_{\text{shift}}^{\text{RA}} n_{\text{group}}^{\text{RA}} + \overline{n}_{\text{shift}}^{\text{RA}}$$

and N_{CS} is given by Tables 5.7.2-2 and 5.7.2-3 for preamble formats 0-3 and 4, respectively, where the higher-layer parameters *zeroCorrelationZoneConfig* and *zeroCorrelationZoneConfigHighSpeed* shall be used for PRACH preamble Set 1 and Set 2 (if configured), respectively. Restricted set type B shall be used for PRACH preamble Set 2 (if configured), and the parameter *High-speed-flag* provided by higher layers determines if unrestricted set or restricted set type A shall be used for PRACH preamble Set 1.

The variable d_u is the cyclic shift corresponding to a Doppler shift of magnitude $1/T_{\text{SEQ}}$ and is given by

$$d_u = \begin{cases} p & 0 \leq p < N_{ZC}/2 \\ N_{ZC} - p & \text{otherwise} \end{cases}$$

where p is the smallest non-negative integer that fulfils $(pu) \bmod N_{ZC} = 1$. The parameters for restricted sets of cyclic shifts depend on d_u .

For restricted set type A and $N_{CS} \leq d_u < N_{ZC}/3$, the parameters are given by

$$\begin{aligned}
n_{\text{shift}}^{\text{RA}} &= \lfloor d_u / N_{\text{CS}} \rfloor \\
d_{\text{start}} &= 2d_u + n_{\text{shift}}^{\text{RA}} N_{\text{CS}} \\
n_{\text{group}}^{\text{RA}} &= \lfloor N_{\text{ZC}} / d_{\text{start}} \rfloor \\
\bar{n}_{\text{shift}}^{\text{RA}} &= \max\left(\lfloor (N_{\text{ZC}} - 2d_u - n_{\text{group}}^{\text{RA}} d_{\text{start}}) / N_{\text{CS}} \rfloor, 0\right)
\end{aligned}$$

For restricted set type A and $N_{\text{ZC}}/3 \leq d_u \leq (N_{\text{ZC}} - N_{\text{CS}})/2$, the parameters are given by

$$\begin{aligned}
n_{\text{shift}}^{\text{RA}} &= \lfloor (N_{\text{ZC}} - 2d_u) / N_{\text{CS}} \rfloor \\
d_{\text{start}} &= N_{\text{ZC}} - 2d_u + n_{\text{shift}}^{\text{RA}} N_{\text{CS}} \\
n_{\text{group}}^{\text{RA}} &= \lfloor d_u / d_{\text{start}} \rfloor \\
\bar{n}_{\text{shift}}^{\text{RA}} &= \min\left(\max\left(\lfloor (d_u - n_{\text{group}}^{\text{RA}} d_{\text{start}}) / N_{\text{CS}} \rfloor, 0\right), n_{\text{shift}}^{\text{RA}}\right)
\end{aligned}$$

For restricted set type B and $N_{\text{CS}} \leq d_u < N_{\text{ZC}}/5$, the parameters are given by

$$\begin{aligned}
n_{\text{shift}}^{\text{RA}} &= \lfloor d_u / N_{\text{CS}} \rfloor \\
d_{\text{start}} &= 4d_u + n_{\text{shift}}^{\text{RA}} N_{\text{CS}} \\
n_{\text{group}}^{\text{RA}} &= \lfloor N_{\text{ZC}} / d_{\text{start}} \rfloor \\
\bar{n}_{\text{shift}}^{\text{RA}} &= \max\left(\lfloor (N_{\text{ZC}} - 4d_u - n_{\text{group}}^{\text{RA}} d_{\text{start}}) / N_{\text{CS}} \rfloor, 0\right)
\end{aligned}$$

For restricted set type B and $N_{\text{ZC}}/5 \leq d_u \leq (N_{\text{ZC}} - N_{\text{CS}})/4$, the parameters are given by

$$\begin{aligned}
n_{\text{shift}}^{\text{RA}} &= \lfloor (N_{\text{ZC}} - 4d_u) / N_{\text{CS}} \rfloor \\
d_{\text{start}} &= N_{\text{ZC}} - 4d_u + n_{\text{shift}}^{\text{RA}} N_{\text{CS}} \\
n_{\text{group}}^{\text{RA}} &= \lfloor d_u / d_{\text{start}} \rfloor \\
\bar{n}_{\text{shift}}^{\text{RA}} &= \min\left(\max\left(\lfloor (d_u - n_{\text{group}}^{\text{RA}} d_{\text{start}}) / N_{\text{CS}} \rfloor, 0\right), n_{\text{shift}}^{\text{RA}}\right)
\end{aligned}$$

For restricted set type B and $(N_{\text{ZC}} + N_{\text{CS}})/4 \leq d_u < 2N_{\text{ZC}}/7$, the parameters are given by

$$\begin{aligned}
n_{\text{shift}}^{\text{RA}} &= \lfloor (4d_u - N_{\text{ZC}}) / N_{\text{CS}} \rfloor \\
d_{\text{start}} &= 4d_u - N_{\text{ZC}} + n_{\text{shift}}^{\text{RA}} N_{\text{CS}} \\
\bar{d}_{\text{start}} &= N_{\text{ZC}} - 3d_u + n_{\text{group}}^{\text{RA}} d_{\text{start}} + \bar{n}_{\text{shift}}^{\text{RA}} N_{\text{CS}} \\
\bar{\bar{d}}_{\text{start}} &= N_{\text{ZC}} - 2d_u + n_{\text{group}}^{\text{RA}} d_{\text{start}} + \bar{\bar{n}}_{\text{shift}}^{\text{RA}} N_{\text{CS}} \\
n_{\text{group}}^{\text{RA}} &= \lfloor d_u / d_{\text{start}} \rfloor \\
\bar{n}_{\text{shift}}^{\text{RA}} &= \max\left(\lfloor (N_{\text{ZC}} - 3d_u - n_{\text{group}}^{\text{RA}} d_{\text{start}}) / N_{\text{CS}} \rfloor, 0\right) \\
\bar{\bar{n}}_{\text{shift}}^{\text{RA}} &= \lfloor \min(d_u - n_{\text{group}}^{\text{RA}} d_{\text{start}}, 4d_u - N_{\text{ZC}} - \bar{n}_{\text{shift}}^{\text{RA}} N_{\text{CS}}) / N_{\text{CS}} \rfloor \\
\bar{\bar{\bar{n}}}_{\text{shift}}^{\text{RA}} &= \lfloor \left((1 - \min(1, \bar{n}_{\text{shift}}^{\text{RA}})) (d_u - n_{\text{group}}^{\text{RA}} d_{\text{start}}) + \min(1, \bar{\bar{n}}_{\text{shift}}^{\text{RA}}) (4d_u - N_{\text{ZC}} - \bar{n}_{\text{shift}}^{\text{RA}} N_{\text{CS}}) \right) / N_{\text{CS}} \rfloor - \bar{\bar{\bar{n}}}_{\text{shift}}^{\text{RA}}
\end{aligned}$$

For restricted set type B and $2N_{\text{ZC}}/7 \leq d_u \leq (N_{\text{ZC}} - N_{\text{CS}})/3$, the parameters are given by

$$\begin{aligned}
n_{\text{shift}}^{\text{RA}} &= \lfloor (N_{\text{ZC}} - 3d_u) / N_{\text{CS}} \rfloor \\
d_{\text{start}} &= N_{\text{ZC}} - 3d_u + n_{\text{shift}}^{\text{RA}} N_{\text{CS}} \\
\bar{d}_{\text{start}} &= d_u + n_{\text{group}}^{\text{RA}} d_{\text{start}} + \bar{n}_{\text{shift}}^{\text{RA}} N_{\text{CS}} \\
\bar{\bar{d}}_{\text{start}} &= 0 \\
n_{\text{group}}^{\text{RA}} &= \lfloor d_u / d_{\text{start}} \rfloor \\
\bar{n}_{\text{shift}}^{\text{RA}} &= \max(\lfloor (4d_u - N_{\text{ZC}} - n_{\text{group}}^{\text{RA}} d_{\text{start}}) / N_{\text{CS}} \rfloor, 0) \\
\bar{\bar{n}}_{\text{shift}}^{\text{RA}} &= \lfloor \min(d_u - n_{\text{group}}^{\text{RA}} d_{\text{start}}, N_{\text{ZC}} - 3d_u - \bar{n}_{\text{shift}}^{\text{RA}} N_{\text{CS}}) / N_{\text{CS}} \rfloor \\
\bar{\bar{\bar{n}}}_{\text{shift}}^{\text{RA}} &= 0
\end{aligned}$$

For restricted set type B and $(N_{\text{ZC}} + N_{\text{CS}}) / 3 \leq d_u < 2N_{\text{ZC}} / 5$, the parameters are given by

$$\begin{aligned}
n_{\text{shift}}^{\text{RA}} &= \lfloor (3d_u - N_{\text{ZC}}) / N_{\text{CS}} \rfloor \\
d_{\text{start}} &= 3d_u - N_{\text{ZC}} + n_{\text{shift}}^{\text{RA}} N_{\text{CS}} \\
\bar{d}_{\text{start}} &= 0 \\
\bar{\bar{d}}_{\text{start}} &= 0 \\
n_{\text{group}}^{\text{RA}} &= \lfloor d_u / d_{\text{start}} \rfloor \\
\bar{n}_{\text{shift}}^{\text{RA}} &= \max(\lfloor (N_{\text{ZC}} - 2d_u - n_{\text{group}}^{\text{RA}} d_{\text{start}}) / N_{\text{CS}} \rfloor, 0) \\
\bar{\bar{n}}_{\text{shift}}^{\text{RA}} &= 0 \\
\bar{\bar{\bar{n}}}_{\text{shift}}^{\text{RA}} &= 0
\end{aligned}$$

For restricted set type B and $2N_{\text{ZC}} / 5 \leq d_u \leq (N_{\text{ZC}} - N_{\text{CS}}) / 2$, the parameters are given by

$$\begin{aligned}
n_{\text{shift}}^{\text{RA}} &= \lfloor (N_{\text{ZC}} - 2d_u) / N_{\text{CS}} \rfloor \\
d_{\text{start}} &= 2(N_{\text{ZC}} - 2d_u) + n_{\text{shift}}^{\text{RA}} N_{\text{CS}} \\
\bar{d}_{\text{start}} &= 0 \\
\bar{\bar{d}}_{\text{start}} &= 0 \\
n_{\text{group}}^{\text{RA}} &= \lfloor (N_{\text{ZC}} - d_u) / d_{\text{start}} \rfloor \\
\bar{n}_{\text{shift}}^{\text{RA}} &= \max(\lfloor (3d_u - N_{\text{ZC}} - n_{\text{group}}^{\text{RA}} d_{\text{start}}) / N_{\text{CS}} \rfloor, 0) \\
\bar{\bar{n}}_{\text{shift}}^{\text{RA}} &= 0 \\
\bar{\bar{\bar{n}}}_{\text{shift}}^{\text{RA}} &= 0
\end{aligned}$$

For all other values of d_u , there are no cyclic shifts in the restricted set.

Table 5.7.2-1: Random access preamble sequence length

Preamble format	N_{ZC}
0 – 3	839
4	139

Table 5.7.2-2: N_{CS} for preamble generation (preamble formats 0-3)

<i>zeroCorrelationZoneConfig</i> , <i>zeroCorrelationZoneConfigHighSpeed</i>	N_{CS} value		
	Unrestricted set	Restricted set type A	Restricted set type B
0	0	15	15
1	13	18	18
2	15	22	22
3	18	26	26
4	22	32	32
5	26	38	38
6	32	46	46
7	38	55	55
8	46	68	68
9	59	82	82
10	76	100	100
11	93	128	118
12	119	158	137
13	167	202	-
14	279	237	-
15	419	-	-

Table 5.7.2-3: N_{CS} for preamble generation (preamble format 4)

<i>zeroCorrelationZoneConfig</i>	N_{CS} value
0	2
1	4
2	6
3	8
4	10
5	12
6	15
7	N/A
8	N/A
9	N/A
10	N/A
11	N/A
12	N/A
13	N/A
14	N/A
15	N/A

Table 5.7.2-4: Root Zadoff-Chu sequence order for preamble formats 0 – 3

Logical root sequence number	Physical root sequence number u (in increasing order of the corresponding logical sequence number)
0–23	129, 710, 140, 699, 120, 719, 210, 629, 168, 671, 84, 755, 105, 734, 93, 746, 70, 769, 60, 779, 2, 837, 1, 838
24–29	56, 783, 112, 727, 148, 691
30–35	80, 759, 42, 797, 40, 799
36–41	35, 804, 73, 766, 146, 693
42–51	31, 808, 28, 811, 30, 809, 27, 812, 29, 810
52–63	24, 815, 48, 791, 68, 771, 74, 765, 178, 661, 136, 703
64–75	86, 753, 78, 761, 43, 796, 39, 800, 20, 819, 21, 818
76–89	95, 744, 202, 637, 190, 649, 181, 658, 137, 702, 125, 714, 151, 688
90–115	217, 622, 128, 711, 142, 697, 122, 717, 203, 636, 118, 721, 110, 729, 89, 750, 103, 736, 61, 778, 55, 784, 15, 824, 14, 825
116–135	12, 827, 23, 816, 34, 805, 37, 802, 46, 793, 207, 632, 179, 660, 145, 694, 130, 709, 223, 616
136–167	228, 611, 227, 612, 132, 707, 133, 706, 143, 696, 135, 704, 161, 678, 201, 638, 173, 666, 106, 733, 83, 756, 91, 748, 66, 773, 53, 786, 10, 829, 9, 830
168–203	7, 832, 8, 831, 16, 823, 47, 792, 64, 775, 57, 782, 104, 735, 101, 738, 108, 731, 208, 631, 184, 655, 197, 642, 191, 648, 121, 718, 141, 698, 149, 690, 216, 623, 218, 621
204–263	152, 687, 144, 695, 134, 705, 138, 701, 199, 640, 162, 677, 176, 663, 119, 720, 158, 681, 164, 675, 174, 665, 171, 668, 170, 669, 87, 752, 169, 670, 88, 751, 107, 732, 81, 758, 82, 757, 100, 739, 98, 741, 71, 768, 59, 780, 65, 774, 50, 789, 49, 790, 26, 813, 17, 822, 13, 826, 6, 833
264–327	5, 834, 33, 806, 51, 788, 75, 764, 99, 740, 96, 743, 97, 742, 166, 673, 172, 667, 175, 664, 187, 652, 163, 676, 185, 654, 200, 639, 114, 725, 189, 650, 115, 724, 194, 645, 195, 644, 192, 647, 182, 657, 157, 682, 156, 683, 211, 628, 154, 685, 123, 716, 139, 700, 212, 627, 153, 686, 213, 626, 215, 624, 150, 689
328–383	225, 614, 224, 615, 221, 618, 220, 619, 127, 712, 147, 692, 124, 715, 193, 646, 205, 634, 206, 633, 116, 723, 160, 679, 186, 653, 167, 672, 79, 760, 85, 754, 77, 762, 92, 747, 58, 781, 62, 777, 69, 770, 54, 785, 36, 803, 32, 807, 25, 814, 18, 821, 11, 828, 4, 835
384–455	3, 836, 19, 820, 22, 817, 41, 798, 38, 801, 44, 795, 52, 787, 45, 794, 63, 776, 67, 772, 72, 767, 76, 763, 94, 745, 102, 737, 90, 749, 109, 730, 165, 674, 111, 728, 209, 630, 204, 635, 117, 722, 188, 651, 159, 680, 198, 641, 113, 726, 183, 656, 180, 659, 177, 662, 196, 643, 155, 684, 214, 625, 126, 713, 131, 708, 219, 620, 222, 617, 226, 613
456–513	230, 609, 232, 607, 262, 577, 252, 587, 418, 421, 416, 423, 413, 426, 411, 428, 376, 463, 395, 444, 283, 556, 285, 554, 379, 460, 390, 449, 363, 476, 384, 455, 388, 451, 386, 453, 361, 478, 387, 452, 360, 479, 310, 529, 354, 485, 328, 511, 315, 524, 337, 502, 349, 490, 335, 504, 324, 515
514–561	323, 516, 320, 519, 334, 505, 359, 480, 295, 544, 385, 454, 292, 547, 291, 548, 381, 458, 399, 440, 380, 459, 397, 442, 369, 470, 377, 462, 410, 429, 407, 432, 281, 558, 414, 425, 247, 592, 277, 562, 271, 568, 272, 567, 264, 575, 259, 580
562–629	237, 602, 239, 600, 244, 595, 243, 596, 275, 564, 278, 561, 250, 589, 246, 593, 417, 422, 248, 591, 394, 445, 393, 446, 370, 469, 365, 474, 300, 539, 299, 540, 364, 475, 362, 477, 298, 541, 312, 527, 313, 526, 314, 525, 353, 486, 352, 487, 343, 496, 327, 512, 350, 489, 326, 513, 319, 520, 332, 507, 333, 506, 348, 491, 347, 492, 322, 517
630–659	330, 509, 338, 501, 341, 498, 340, 499, 342, 497, 301, 538, 366, 473, 401, 438, 371, 468, 408, 431, 375, 464, 249, 590, 269, 570, 238, 601, 234, 605
660–707	257, 582, 273, 566, 255, 584, 254, 585, 245, 594, 251, 588, 412, 427, 372, 467, 282, 557, 403, 436, 396, 443, 392, 447, 391, 448, 382, 457, 389, 450, 294, 545, 297, 542, 311, 528, 344, 495, 345, 494, 318, 521, 331, 508, 325, 514, 321, 518
708–729	346, 493, 339, 500, 351, 488, 306, 533, 289, 550, 400, 439, 378, 461, 374, 465, 415, 424, 270, 569, 241, 598
730–751	231, 608, 260, 579, 268, 571, 276, 563, 409, 430, 398, 441, 290, 549, 304, 535, 308, 531, 358, 481, 316, 523
752–765	293, 546, 288, 551, 284, 555, 368, 471, 253, 586, 256, 583, 263, 576
766–777	242, 597, 274, 565, 402, 437, 383, 456, 357, 482, 329, 510
778–789	317, 522, 307, 532, 286, 553, 287, 552, 266, 573, 261, 578
790–795	236, 603, 303, 536, 356, 483
796–803	355, 484, 405, 434, 404, 435, 406, 433
804–809	235, 604, 267, 572, 302, 537
810–815	309, 530, 265, 574, 233, 606
816–819	367, 472, 296, 543
820–837	336, 503, 305, 534, 373, 466, 280, 559, 279, 560, 419, 420, 240, 599, 258, 581, 229, 610

Table 5.7.2-5: Root Zadoff-Chu sequence order for preamble format 4

Logical root sequence number	Physical root sequence number u (in increasing order of the corresponding logical sequence number)																			
	0 – 19	1	138	2	137	3	136	4	135	5	134	6	133	7	132	8	131	9	130	10
20 – 39	11	128	12	127	13	126	14	125	15	124	16	123	17	122	18	121	19	120	20	119
40 – 59	21	118	22	117	23	116	24	115	25	114	26	113	27	112	28	111	29	110	30	109
60 – 79	31	108	32	107	33	106	34	105	35	104	36	103	37	102	38	101	39	100	40	99
80 – 99	41	98	42	97	43	96	44	95	45	94	46	93	47	92	48	91	49	90	50	89
100 – 119	51	88	52	87	53	86	54	85	55	84	56	83	57	82	58	81	59	80	60	79
120 – 137	61	78	62	77	63	76	64	75	65	74	66	73	67	72	68	71	69	70	-	-
138 – 837	N/A																			

5.7.3 Baseband signal generation

The time-continuous random access signal $s(t)$ is defined by

$$s(t) = \beta_{\text{PRACH}} \sum_{k=0}^{N_{\text{ZC}}-1} \sum_{n=0}^{N_{\text{ZC}}-1} x_{u,v}(n) \cdot e^{-j \frac{2\pi n k}{N_{\text{ZC}}}} \cdot e^{j 2\pi (k + \varphi + K(k_0 + \frac{1}{2})) \Delta f_{\text{RA}} (t - T_{\text{CP}})}$$

where $0 \leq t < T_{\text{SEQ}} + T_{\text{CP}}$, β_{PRACH} is an amplitude scaling factor in order to conform to the transmit power P_{PRACH} specified in clause 6.1 in 3GPP TS 36.213 [4], and $k_0 = n_{\text{PRB}}^{\text{RA}} N_{\text{sc}}^{\text{RB}} - N_{\text{RB}}^{\text{UL}} N_{\text{sc}}^{\text{RB}} / 2$. The location in the frequency domain is controlled by the parameter $n_{\text{PRB}}^{\text{RA}}$ is derived from clause 5.7.1. The factor $K = \Delta f / \Delta f_{\text{RA}}$ accounts for the difference in subcarrier spacing between the random access preamble and uplink data transmission. The variable Δf_{RA} , the subcarrier spacing for the random access preamble, and the variable φ , a fixed offset determining the frequency-domain location of the random access preamble within the physical resource blocks, are both given by Table 5.7.3-1.

Table 5.7.3-1: Random access baseband parameters

Preamble format	Δf_{RA}	φ
0 – 3	1250 Hz	7
4	7500 Hz	2

5.8 Modulation and upconversion

Modulation and upconversion to the carrier frequency of the complex-valued SC-FDMA baseband signal for each antenna port or the complex-valued PRACH baseband signal is shown in Figure 5.8-1. The filtering required prior to transmission is defined by the requirements in 3GPP TS 36.101 [7].

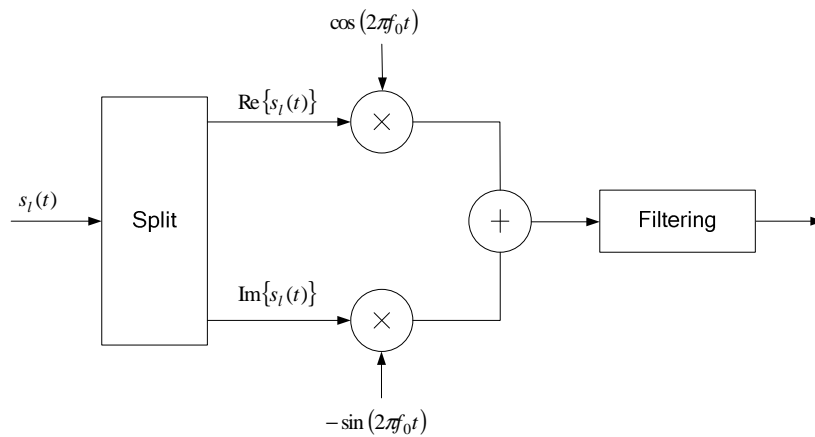

Figure 5.8-1: Uplink modulation

6 Downlink

6.1 Overview

The smallest time-frequency unit for downlink transmission is denoted a resource element and is defined in clause 6.2.2.

A subset of the downlink subframes in a radio frame can be configured as MBSFN subframes by higher layers. Each MBSFN subframe is divided into a non-MBSFN region and an MBSFN region.

- For subframes using $\Delta f = 15$ kHz, the non-MBSFN region spans the first one or two OFDM symbols in an MBSFN subframe where the length of the non-MBSFN region is given according to Clause 6.7.
- For subframes using $\Delta f = 7.5$ kHz, $\Delta f = 2.5$ kHz, $\Delta f = 1.25$ kHz, or $\Delta f = 1/(82944T_s) \approx 0.37$ kHz, the non-MBSFN region is of zero size.
- The MBSFN region in an MBSFN subframe is defined as the OFDM symbols not used for the non-MBSFN region. For $\Delta f \approx 0.37$ kHz the MBSFN region is defined as one slot of 3 ms.

For an MBMS-dedicated cell, subframes where PSS/SSS/PBCH or PDSCH carrying system information are transmitted with $\Delta f = 15$ kHz are non-MBSFN subframes.

For frame structure type 3, MBSFN configuration shall not be applied to downlink subframes in which at least one OFDM symbol is not occupied or discovery signal is transmitted.

Unless otherwise specified, transmission in each downlink subframe shall use the same cyclic prefix length as used for downlink subframe #0.

6.1.1 Physical channels

A downlink physical channel corresponds to a set of resource elements carrying information originating from higher layers and is the interface defined between 3GPP TS 36.212 [3] and the present document 3GPP TS 36.211.

The following downlink physical channels are defined:

- Physical Downlink Shared Channel, PDSCH
- Physical Broadcast Channel, PBCH
- Physical Multicast Channel, PMCH
- Physical Control Format Indicator Channel, PCFICH
- Physical Downlink Control Channel, PDCCH
- Physical Hybrid ARQ Indicator Channel, PHICH
- Enhanced Physical Downlink Control Channel, EPDCCH
- MTC Physical Downlink Control Channel, MPDCCH
- Short Physical Downlink Control Channel, SPDCCH

6.1.2 Physical signals

A downlink physical signal corresponds to a set of resource elements used by the physical layer but does not carry information originating from higher layers. The following downlink physical signals are defined:

- Reference signal
- Synchronization signal

- Discovery signal
- MTC wake-up signal, MWUS

6.2 Slot structure and physical resource elements

6.2.1 Resource grid

The transmitted signal in each slot is described by one or several resource grids of $N_{RB}^{DL} N_{sc}^{RB}$ subcarriers and N_{symb}^{DL} OFDM symbols. The resource grid structure is illustrated in Figure 6.2.2-1. The quantity N_{RB}^{DL} depends on the downlink transmission bandwidth configured in the cell and shall fulfil

$$N_{RB}^{\min,DL} \leq N_{RB}^{DL} \leq N_{RB}^{\max,DL}$$

where $N_{RB}^{\min,DL} = 6$ and $N_{RB}^{\max,DL} = 110$ are the smallest and largest downlink bandwidths, respectively, supported by the current version of this specification.

The set of allowed values for N_{RB}^{DL} is given by 3GPP TS 36.104 [6]. The number of OFDM symbols in a slot depends on the cyclic prefix length and subcarrier spacing configured and is given in Table 6.2.3-1.

An antenna port is defined such that the channel over which a symbol on the antenna port is conveyed can be inferred from the channel over which another symbol on the same antenna port is conveyed. For MBSFN reference signals, positioning reference signals, UE-specific reference signals associated with PDSCH, demodulation reference signals associated with SPDCCH, and demodulation reference signals associated with EPDCCH, there are limits given below within which the channel can be inferred from one symbol to another symbol on the same antenna port. There is one resource grid per antenna port. The set of antenna ports supported depends on the reference signal configuration in the cell:

- Cell-specific reference signals support a configuration of one, two, or four antenna ports and are transmitted on antenna ports $p = 0$, $p \in \{0,1\}$, and $p \in \{0,1,2,3\}$, respectively.
- MBSFN reference signals are transmitted on antenna port $p = 4$. The channel over which a symbol on antenna port $p = 4$ is conveyed can be inferred from the channel over which another symbol on the same antenna port is conveyed only if the two symbols correspond to subframes (slots in case of 0.37 kHz subcarrier spacing) of the same MBSFN area.
- UE-specific reference signals associated with PDSCH intended for non-BL/CE UE are transmitted on antenna port(s) $p = 5$, $p = 7$, $p = 8$, or one or several of $p \in \{7,8,9,10,11,12,13,14\}$. The channel over which a symbol on one of these antenna ports is conveyed can be inferred from the channel over which another symbol on the same antenna port is conveyed only if the two symbols are within the same subframe and in the same PRG when PRB bundling is used or in the same PRB pair when PRB bundling is not used.
- UE-specific reference signals associated with PDSCH intended for BL/CE UE are transmitted on one or several of antenna port(s) $p \in \{7,8,9,10,11,12,13,14\}$. The channel over which a symbol on one of these antenna ports is conveyed can be inferred from the channel over which another symbol on the same antenna port is conveyed only if the two symbols are in the same set of $N_{NB}^{\text{ch},DL}$ consecutive subframes and have the same PRB index.
- Demodulation reference signals associated with EPDCCH are transmitted on one or several of $p \in \{107,108,109,110\}$. The channel over which a symbol on one of these antenna ports is conveyed can be inferred from the channel over which another symbol on the same antenna port is conveyed only if the two symbols are in the same PRB pair.
- Demodulation reference signals associated with MPDCCH are transmitted on one or several of $p \in \{107,108,109,110\}$. The channel over which a symbol on one of these antenna ports is conveyed can be inferred from the channel over which another symbol on the same antenna port is conveyed only if the two symbols are in the same set of $N_{NB}^{\text{ch},DL}$ consecutive subframes and have the same PRB index.

- Demodulation reference signals associated with SPDCCH are transmitted on $p \in \{1, 0, 7\}$.
- Positioning reference signals are transmitted on antenna port $p = 6$. The channel over which a symbol on antenna port $p = 6$ is conveyed can be inferred from the channel over which another symbol on the same antenna port is conveyed only within one positioning reference signal occasion consisting of N_{PRS} consecutive downlink subframes, where N_{PRS} is configured by higher layers.
- CSI reference signals support a configuration of 1, 2, 4, 8, 12, 16, 20, 24, 28, or 32 antenna ports and are transmitted on antenna ports $p = 15$, $p = 15, 16$, $p = 15, \dots, 18$, $p = 15, \dots, 22$, $p = 15, \dots, 26$, $p = 15, \dots, 30$, $p = 15, \dots, 34$, $p = 15, \dots, 38$, $p = 15, \dots, 42$ and $p = 15, \dots, 46$, respectively.

Two antenna ports are said to be quasi co-located if the large-scale properties of the channel over which a symbol on one antenna port is conveyed can be inferred from the channel over which a symbol on the other antenna port is conveyed. The large-scale properties include one or more of delay spread, Doppler spread, Doppler shift, average gain, and average delay.

6.2.2 Resource elements

Each element in the resource grid for antenna port p is called a resource element and is uniquely identified by the index pair (k, l) in a slot where $k = 0, \dots, N_{\text{RB}}^{\text{DL}} N_{\text{sc}}^{\text{RB}} - 1$ and $l = 0, \dots, N_{\text{ymb}}^{\text{DL}} - 1$ are the indices in the frequency and time domains, respectively. Resource element (k, l) on antenna port p corresponds to the complex value $a_{k,l}^{(p)}$.

When there is no risk for confusion, or no particular antenna port is specified, the index p may be dropped.

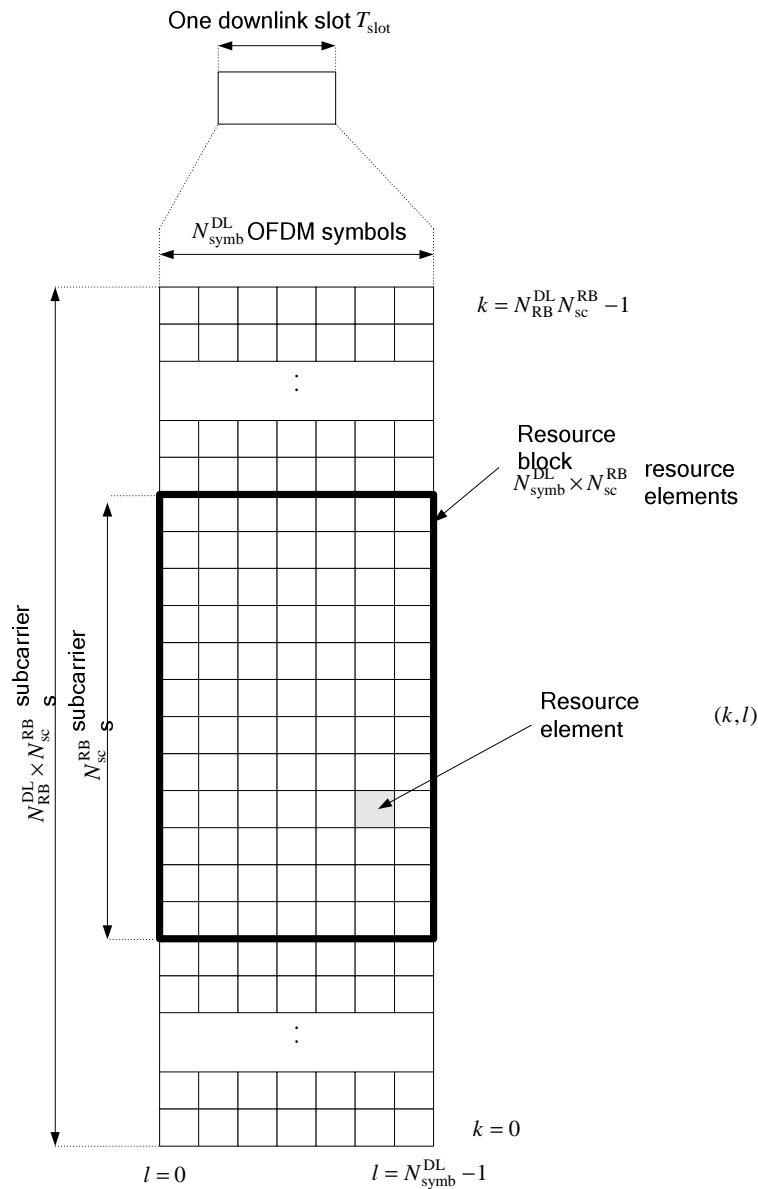

Figure 6.2.2-1: Downlink resource grid

6.2.3 Resource blocks

Resource blocks are used to describe the mapping of certain physical channels to resource elements. Physical and virtual resource blocks are defined.

A physical resource block is defined as N_{symb}^{DL} consecutive OFDM symbols in the time domain and N_{sc}^{RB} consecutive subcarriers in the frequency domain, where N_{symb}^{DL} and N_{sc}^{RB} are given by Table 6.2.3-1. A physical resource block thus consists of $N_{symb}^{DL} \times N_{sc}^{RB}$ resource elements, corresponding to one slot in the time domain and 180 kHz in the frequency domain.

Physical resource blocks are numbered from 0 to $N_{RB}^{DL} - 1$ in the frequency domain. The relation between the physical resource block number n_{PRB} in the frequency domain and resource elements (k, l) in a slot is given by

$$n_{PRB} = \left\lfloor \frac{k}{N_{sc}^{RB}} \right\rfloor$$

Table 6.2.3-1: Physical resource blocks parameters

Configuration		N_{sc}^{RB}	N_{symbol}^{DL}
Normal cyclic prefix	$\Delta f = 15$ kHz	12	7
	$\Delta f = 7.5$ kHz		6
Extended cyclic prefix	$\Delta f = 7.5$ kHz	24	3
	$\Delta f = 2.5$ kHz	72	1
	$\Delta f = 1.25$ kHz	144	1
	$\Delta f \approx 0.37$ kHz	486	1

Except for subcarrier spacing $\Delta f = 1.25$ kHz and $\Delta f \approx 0.37$ kHz, a physical resource-block pair is defined as the two physical resource blocks in one subframe having the same physical resource-block number n_{PRB} .

A virtual resource block is of the same size as a physical resource block. Two types of virtual resource blocks are defined:

- Virtual resource blocks of localized type
- Virtual resource blocks of distributed type

For each type of virtual resource blocks, a pair of virtual resource blocks over two slots in a subframe is assigned together by a single virtual resource block number, n_{VRB} .

6.2.3.1 Virtual resource blocks of localized type

Virtual resource blocks of localized type are mapped directly to physical resource blocks such that virtual resource block n_{VRB} corresponds to physical resource block $n_{PRB} = n_{VRB}$. Virtual resource blocks are numbered from 0 to $N_{VRB}^{DL} - 1$, where $N_{VRB}^{DL} = N_{RB}^{DL}$.

6.2.3.2 Virtual resource blocks of distributed type

Virtual resource blocks of distributed type are mapped to physical resource blocks as described below.

Table 6.2.3.2-1: RB gap values

System BW (N_{RB}^{DL})	Gap (N_{gap})	
	1 st Gap ($N_{\text{gap},1}$)	2 nd Gap ($N_{\text{gap},2}$)
6-10	$\lceil N_{RB}^{DL} / 2 \rceil$	N/A
11	4	N/A
12-19	8	N/A
20-26	12	N/A
27-44	18	N/A
45-49	27	N/A
50-63	27	9
64-79	32	16
80-110	48	16

The parameter N_{gap} is given by Table 6.2.3.2-1. For $6 \leq N_{RB}^{DL} \leq 49$, only one gap value $N_{\text{gap},1}$ is defined and $N_{\text{gap}} = N_{\text{gap},1}$. For $50 \leq N_{RB}^{DL} \leq 110$, two gap values $N_{\text{gap},1}$ and $N_{\text{gap},2}$ are defined. Whether $N_{\text{gap}} = N_{\text{gap},1}$ or $N_{\text{gap}} = N_{\text{gap},2}$ is signaled as part of the downlink scheduling assignment as described in 3GPP TS 36.212 [3].

Virtual resource blocks of distributed type are numbered from 0 to $N_{VRB}^{DL} - 1$, where

$$N_{VRB}^{DL} = N_{VRB,\text{gap}1}^{DL} = 2 \cdot \min(N_{\text{gap}}, N_{RB}^{DL} - N_{\text{gap}}) \text{ for } N_{\text{gap}} = N_{\text{gap},1} \text{ and } N_{VRB}^{DL} = N_{VRB,\text{gap}2}^{DL} = \lfloor N_{RB}^{DL} / 2N_{\text{gap}} \rfloor \cdot 2N_{\text{gap}} \text{ for}$$

$$N_{\text{gap}} = N_{\text{gap},2}.$$

Consecutive $\tilde{N}_{\text{VRB}}^{\text{DL}}$ VRB numbers compose a unit of VRB number interleaving, where $\tilde{N}_{\text{VRB}}^{\text{DL}} = N_{\text{VRB}}^{\text{DL}}$ for $N_{\text{gap}} = N_{\text{gap},1}$ and $\tilde{N}_{\text{VRB}}^{\text{DL}} = 2N_{\text{gap}}$ for $N_{\text{gap}} = N_{\text{gap},2}$. Interleaving of VRB numbers of each interleaving unit is performed with 4 columns and N_{row} rows, where $N_{\text{row}} = \lceil \tilde{N}_{\text{VRB}}^{\text{DL}} / (4P) \rceil \cdot P$, and P is RBG size as described in 3GPP TS 36.213 [4]. VRB numbers are written row by row in the rectangular matrix, and read out column by column. N_{null} nulls are inserted in the last $N_{\text{null}}/2$ rows of the 2nd and 4th column, where $N_{\text{null}} = 4N_{\text{row}} - \tilde{N}_{\text{VRB}}^{\text{DL}}$. Nulls are ignored when reading out. The VRB numbers mapping to PRB numbers including interleaving is derived as follows:

For even slot number n_s ;

$$\tilde{n}_{\text{PRB}}(n_s) = \begin{cases} \tilde{n}'_{\text{PRB}} - N_{\text{row}} & , N_{\text{null}} \neq 0 \text{ and } \tilde{n}_{\text{VRB}} \geq \tilde{N}_{\text{VRB}}^{\text{DL}} - N_{\text{null}} \text{ and } \tilde{n}_{\text{VRB}} \bmod 2 = 1 \\ \tilde{n}'_{\text{PRB}} - N_{\text{row}} + N_{\text{null}}/2 & , N_{\text{null}} \neq 0 \text{ and } \tilde{n}_{\text{VRB}} \geq \tilde{N}_{\text{VRB}}^{\text{DL}} - N_{\text{null}} \text{ and } \tilde{n}_{\text{VRB}} \bmod 2 = 0 \\ \tilde{n}''_{\text{PRB}} - N_{\text{null}}/2 & , N_{\text{null}} \neq 0 \text{ and } \tilde{n}_{\text{VRB}} < \tilde{N}_{\text{VRB}}^{\text{DL}} - N_{\text{null}} \text{ and } \tilde{n}_{\text{VRB}} \bmod 4 \geq 2 \\ \tilde{n}''_{\text{PRB}} & , \text{otherwise} \end{cases},$$

$$\text{where } \tilde{n}'_{\text{PRB}} = 2N_{\text{row}} \cdot (\tilde{n}_{\text{VRB}} \bmod 2) + \lfloor \tilde{n}_{\text{VRB}}/2 \rfloor + \tilde{N}_{\text{VRB}}^{\text{DL}} \cdot \lfloor n_{\text{VRB}} / \tilde{N}_{\text{VRB}}^{\text{DL}} \rfloor,$$

$$\text{and } \tilde{n}''_{\text{PRB}} = N_{\text{row}} \cdot (\tilde{n}_{\text{VRB}} \bmod 4) + \lfloor \tilde{n}_{\text{VRB}}/4 \rfloor + \tilde{N}_{\text{VRB}}^{\text{DL}} \cdot \lfloor n_{\text{VRB}} / \tilde{N}_{\text{VRB}}^{\text{DL}} \rfloor,$$

where $\tilde{n}_{\text{VRB}} = n_{\text{VRB}} \bmod \tilde{N}_{\text{VRB}}^{\text{DL}}$ and n_{VRB} is obtained from the downlink scheduling assignment as described in 3GPP TS 36.213 [4].

For odd slot number n_s ;

$$\tilde{n}_{\text{PRB}}(n_s) = (\tilde{n}_{\text{PRB}}(n_s - 1) + \tilde{N}_{\text{VRB}}^{\text{DL}}/2) \bmod \tilde{N}_{\text{VRB}}^{\text{DL}} + \tilde{N}_{\text{VRB}}^{\text{DL}} \cdot \lfloor n_{\text{VRB}} / \tilde{N}_{\text{VRB}}^{\text{DL}} \rfloor$$

Then, for all n_s ;

$$n_{\text{PRB}}(n_s) = \begin{cases} \tilde{n}_{\text{PRB}}(n_s), & \tilde{n}_{\text{PRB}}(n_s) < \tilde{N}_{\text{VRB}}^{\text{DL}}/2 \\ \tilde{n}_{\text{PRB}}(n_s) + N_{\text{gap}} - \tilde{N}_{\text{VRB}}^{\text{DL}}/2, & \tilde{n}_{\text{PRB}}(n_s) \geq \tilde{N}_{\text{VRB}}^{\text{DL}}/2 \end{cases}.$$

Virtual resource blocks of distributed type are not applicable to BL/CE UEs.

6.2.4 Resource-element groups (REGs)

Resource-element groups are used for defining the mapping of control channels to resource elements.

A resource-element group is represented by the index pair (k', l') of the resource element with the lowest index k in the group with all resource elements in the group having the same value of l . The set of resource elements (k, l) in a resource-element group depends on the number of cell-specific reference signals configured as described below with $k_0 = n_{\text{PRB}} \cdot N_{\text{sc}}^{\text{RB}}$, $0 \leq n_{\text{PRB}} < N_{\text{RB}}^{\text{DL}}$.

- In the first OFDM symbol of the first slot in a subframe the two resource-element groups in physical resource block n_{PRB} consist of resource elements $(k, l = 0)$ with $k = k_0 + 0, k_0 + 1, \dots, k_0 + 5$ and $k = k_0 + 6, k_0 + 7, \dots, k_0 + 11$, respectively.
- In the second OFDM symbol of the first slot in a subframe in case of one or two cell-specific reference signals configured, the three resource-element groups in physical resource block n_{PRB} consist of resource elements $(k, l = 1)$ with $k = k_0 + 0, k_0 + 1, \dots, k_0 + 3$, $k = k_0 + 4, k_0 + 5, \dots, k_0 + 7$ and $k = k_0 + 8, k_0 + 9, \dots, k_0 + 11$, respectively.
- In the second OFDM symbol of the first slot in a subframe in case of four cell-specific reference signals configured, the two resource-element groups in physical resource block n_{PRB} consist of resource elements

$(k, l = 1)$ with $k = k_0 + 0, k_0 + 1, \dots, k_0 + 5$ and $k = k_0 + 6, k_0 + 7, \dots, k_0 + 11$, respectively.

- In the third OFDM symbol of the first slot in a subframe, the three resource-element groups in physical resource block n_{PRB} consist of resource elements $(k, l = 2)$ with $k = k_0 + 0, k_0 + 1, \dots, k_0 + 3$, $k = k_0 + 4, k_0 + 5, \dots, k_0 + 7$ and $k = k_0 + 8, k_0 + 9, \dots, k_0 + 11$, respectively.
- In the fourth OFDM symbol of the first slot in a subframe in case of normal cyclic prefix, the three resource-element groups in physical resource block n_{PRB} consist of resource elements $(k, l = 3)$ with $k = k_0 + 0, k_0 + 1, \dots, k_0 + 3$, $k = k_0 + 4, k_0 + 5, \dots, k_0 + 7$ and $k = k_0 + 8, k_0 + 9, \dots, k_0 + 11$, respectively.
- In the fourth OFDM symbol of the first slot in a subframe in case of extended cyclic prefix, the two resource-element groups in physical resource block n_{PRB} consist of resource elements $(k, l = 3)$ with $k = k_0 + 0, k_0 + 1, \dots, k_0 + 5$ and $k = k_0 + 6, k_0 + 7, \dots, k_0 + 11$, respectively.

Mapping of a symbol-quadruplet $\langle z(i), z(i+1), z(i+2), z(i+3) \rangle$ onto a resource-element group represented by resource-element (k', l') is defined such that elements $z(i)$ are mapped to resource elements (k, l) of the resource-element group not used for cell-specific reference signals in increasing order of i and k . In case a single cell-specific reference signal is configured, cell-specific reference signals shall be assumed to be present on antenna ports 0 and 1 for the purpose of mapping a symbol-quadruplet to a resource-element group, otherwise the number of cell-specific reference signals shall be assumed equal to the actual number of antenna ports used for cell-specific reference signals. The UE shall not make any assumptions about resource elements assumed to be reserved for reference signals but not used for transmission of a reference signal.

For frame structure type 3, if the higher layer parameter *subframeStartPosition* indicates 's07' and the downlink transmission starts in the second slot of a subframe, the above definition applies to the second slot of that subframe instead of the first slot.

6.2.4A Enhanced Resource-Element Groups (EREGs)

EREGs are used for defining the mapping of enhanced control channels to resource elements.

There are 16 EREGs, numbered from 0 to 15, per physical resource block pair. Number all resource elements, except resource elements carrying DM-RS for antenna ports $p = \{107, 108, 109, 110\}$ for normal cyclic prefix or $p = \{107, 108\}$ for extended cyclic prefix, in a physical resource-block pair cyclically from 0 to 15 in an increasing order of first frequency, then time. All resource elements with number i in that physical resource-block pair constitutes EREG number i .

For frame structure type 3, if the higher layer parameter *subframeStartPosition* indicates 's07' and the downlink transmission starts in the second slot of a subframe, the above definition applies to the second slot of that subframe instead of the first slot.

6.2.4B Short Resource-Element Groups (SREGs)

Short resource-element groups (SREGs) are used for defining the mapping of short control channels to resource elements.

One SREG is composed of all resource elements in a physical resource block in a given OFDM symbol. The set of resource elements (k, l) in an SREG in physical resource block n_{PRB} consist of resource elements with

$k = k_0 + 0, k_0 + 1, \dots, k_0 + 11$ with $k_0 = n_{\text{PRB}} \cdot N_{\text{sc}}^{\text{RB}}$, $0 \leq n_{\text{PRB}} < N_{\text{RB}}^{\text{DL}}$, all having the same value of l .

6.2.5 Guard period for half-duplex FDD operation

For type A half-duplex FDD operation, a guard period is created by the UE by

- not receiving the last part of a downlink subframe immediately preceding an uplink subframe from the same UE.

For type B half-duplex FDD operation, guard periods, each referred to as a half-duplex guard subframe, are created by the UE by

- not receiving a downlink subframe immediately preceding an uplink subframe from the same UE, and
- not receiving a downlink subframe immediately following an uplink subframe from the same UE.

6.2.6 Guard Period for TDD Operation

For frame structure type 2, the GP field in Figure 4.2-1 serves as a guard period.

6.2.7 Narrowbands and widebands

A narrowband is defined as six non-overlapping consecutive physical resource blocks in the frequency domain. The total number of downlink narrowbands in the downlink transmission bandwidth configured in the cell is given by

$$N_{\text{NB}}^{\text{DL}} = \left\lfloor \frac{N_{\text{RB}}^{\text{DL}}}{6} \right\rfloor$$

The narrowbands are numbered $n_{\text{NB}} = 0, \dots, N_{\text{NB}}^{\text{DL}} - 1$ in order of increasing physical resource-block number where narrowband n_{NB} is composed of physical resource-block indices

$$\begin{cases} 6n_{\text{NB}} + i_0 + i + \bar{i} & \text{if } N_{\text{RB}}^{\text{DL}} \bmod 2 = 0 \\ 6n_{\text{NB}} + i_0 + i + \bar{i} & \text{if } N_{\text{RB}}^{\text{DL}} \bmod 2 = 1 \text{ and } n_{\text{NB}} < N_{\text{NB}}^{\text{DL}} / 2 \\ 6n_{\text{NB}} + i_0 + i + 1 + \bar{i} & \text{if } N_{\text{RB}}^{\text{DL}} \bmod 2 = 1 \text{ and } n_{\text{NB}} \geq N_{\text{NB}}^{\text{DL}} / 2 \end{cases}$$

where

$$i = 0, 1, \dots, 5$$

$$i_0 = \left\lfloor \frac{N_{\text{RB}}^{\text{DL}}}{2} \right\rfloor - \frac{6N_{\text{NB}}^{\text{DL}}}{2}$$

and \bar{i} is according to Table 6.2.7-1 for the narrowbands used for PDSCH resource allocation in CEModeB if the higher-layer parameter *ce-PDSCH-FlexibleStartPRB-AllocConfig* is set, otherwise $\bar{i} = 0$.

If $N_{\text{NB}}^{\text{DL}} \geq 4$, a wideband is defined as four non-overlapping narrowbands in the frequency domain. The total number of downlink widebands in the downlink transmission bandwidth configured in the cell is given by

$$N_{\text{WB}}^{\text{DL}} = \left\lfloor \frac{N_{\text{NB}}^{\text{DL}}}{4} \right\rfloor$$

and the widebands are numbered $n_{\text{WB}} = 0, \dots, N_{\text{WB}}^{\text{DL}} - 1$ in order of increasing narrowband number where wideband n_{WB} is composed of narrowband indices $4n_{\text{WB}} + i$ where $i = 0, 1, \dots, 3$.

If $N_{\text{NB}}^{\text{DL}} < 4$, then $N_{\text{WB}}^{\text{DL}} = 1$ and the single wideband is composed of the $N_{\text{NB}}^{\text{DL}}$ non-overlapping narrowband(s).

Table 6.2.7-1: Shift of narrowbands for PDSCH resource allocation in CEModeB when higher layer parameter *ce-PDSCH-FlexibleStartPRB-AllocConfig* is set.

System bandwidth $N_{\text{RB}}^{\text{DL}}$	Shift of narrowband \bar{i}
6	0
15	-1 for narrowband #0; 0 for narrowband #1
25	0 for narrowbands 0, 1; -1 for narrowbands 2, 3
50	-1 for all narrowbands
75	-1 for narrowbands 0, 1, ..., 5; 0 for narrowbands 6, 7, ..., 11
100	-2 for all narrowbands.

6.2.8 Guard period for narrowband and wideband retuning

For BL/CE UEs, a guard period of at most $N_{\text{symb}}^{\text{retune}}$ OFDM symbols is created for Rx-to-Rx and Tx-to-Rx frequency retuning between two consecutive subframes.

- If the higher layer parameter *ce-RetuningSymbols* is set, then $N_{\text{symb}}^{\text{retune}}$ equals *ce-RetuningSymbols*, otherwise $N_{\text{symb}}^{\text{retune}} = 2$.
- If the higher layer parameter *ce-pdsch-maxBandwidth-config* is set to 5 MHz, then the rules for guard period creation defined in the remainder of this clause apply not for retuning between narrowbands but for retuning between widebands and for transmissions involving multiple widebands.
- If the UE is configured with CEModeA and higher layer parameter *ce-PDSCH-FlexibleStartPRB-AllocConfig*, the rules for guard period creation defined in the remainder of this clause apply for retuning between tuning narrowbands defined for the allocation resources not fully within one narrowband defined in Clause 6.2.7 as the consecutive 6PRBs starting from RB_{start} if RB_{start} is aligned with RBG boundary, or the consecutive 6PRBs ending at $RB_{\text{start}} + L_{\text{CRBs}} - 1$ if $RB_{\text{start}} + L_{\text{CRBs}} - 1$ is aligned with RBG boundary, where RB_{start} and L_{CRBs} are defined in Table 7.1.6.3-2 [4].
- If the UE is configured with CEModeB and higher layer parameter *ce-PDSCH-FlexibleStartPRB-AllocConfig*, the rules for guard period creation defined in the remainder of this clause apply for retuning between the tuning narrowband defined as the narrowband shifted according to Table 6.2.7-1.
- If the UE retunes from a first downlink narrowband to a second downlink narrowband with a different center frequency, a guard period is created by the UE not receiving at most $N_{\text{symb}}^{\text{retune}}$ OFDM symbols in the second narrowband.
- If the UE retunes from a first uplink narrowband to a second downlink narrowband with a different center frequency for frame structure type 2, a guard period is created by the UE not receiving at most $N_{\text{symb}}^{\text{retune}}$ OFDM symbols in the second narrowband.

Furthermore, for BL/CE UEs configured with the higher layer parameter *srs-UpPtsAdd*, a guard period of at most $N_{\text{symb}}^{\text{retune}}$ OFDM or SC-FDMA symbols is created for Rx-to-Tx frequency retuning within a special subframe for frame structure type 2. Primarily, the TDD guard period (GP) specified in clause 4.2 serves as the guard period for narrowband retuning, and if GP is not sufficient then additional guard period is created by the UE according to:

- If SRS is configured to be transmitted in the first UpPTS symbol, the additional guard period is created by the UE not receiving at most $N_{\text{symb}}^{\text{retune}}$ DwPTS symbols in the first narrowband.
- If SRS is configured to be transmitted in the second UpPTS symbol but not in the first UpPTS symbol, the additional guard period is created by the UE primarily by not transmitting the first UpPTS symbol and (if $N_{\text{symb}}^{\text{retune}} = 2$) secondarily by not receiving the last DwPTS symbol.

6.3 General structure for downlink physical channels

This clause describes a general structure, applicable to more than one physical channel.

The baseband signal representing a downlink physical channel is defined in terms of the following steps:

- scrambling of coded bits in each of the codewords to be transmitted on a physical channel
- modulation of scrambled bits to generate complex-valued modulation symbols
- mapping of the complex-valued modulation symbols onto one or several transmission layers
- precoding of the complex-valued modulation symbols on each layer for transmission on the antenna ports
- mapping of complex-valued modulation symbols for each antenna port to resource elements

- generation of complex-valued time-domain OFDM signal for each antenna port

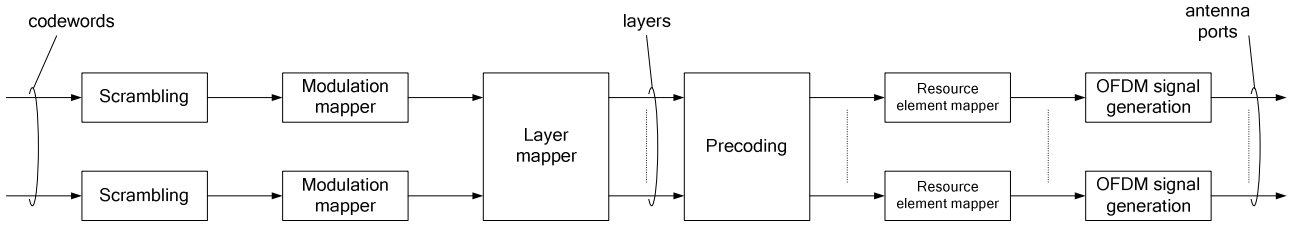

Figure 6.3-1: Overview of physical channel processing

6.3.1 Scrambling

For each codeword q , the block of bits $b^{(q)}(0), \dots, b^{(q)}(M_{\text{bit}}^{(q)} - 1)$, where $M_{\text{bit}}^{(q)}$ is the number of bits in codeword q transmitted on the physical channel in one subframe/slot/subslot, shall be scrambled prior to modulation, resulting in a block of scrambled bits $\tilde{b}^{(q)}(0), \dots, \tilde{b}^{(q)}(M_{\text{bit}}^{(q)} - 1)$ according to

$$\tilde{b}^{(q)}(i) = (b^{(q)}(i) + c^{(q)}(i)) \bmod 2$$

where the scrambling sequence $c^{(q)}(i)$ is given by clause 7.2. The scrambling sequence generator shall be initialised at the start of each subframe, where the initialisation value of c_{init} depends on the transport channel type according to

$$c_{\text{init}} = \begin{cases} n_{\text{RNTI}} \cdot 2^{14} + q \cdot 2^{13} + \lfloor n_s/2 \rfloor \cdot 2^9 + N_{\text{ID}}^{\text{cell}} & \text{for PDSCH} \\ \lfloor n_s/2 \rfloor \cdot 2^9 + N_{\text{ID}}^{\text{MBSFN}} & \text{for PMCH} \end{cases}$$

where n_{RNTI} corresponds to the RNTI associated with the PDSCH transmission as described in clause 7.1 3GPP TS 36.213 [4].

For BL/CE UEs, the same scrambling sequence is applied per subframe to PDSCH for a given block of N_{acc} subframes. The subframe number of the first subframe in each block of N_{acc} consecutive subframes, denoted as $n_{\text{abs},1}$, satisfies $(n_{\text{abs},1} + i_{\Delta}) \bmod N_{\text{acc}} = 0$. For the j^{th} block of N_{acc} subframes, the scrambling sequence generator shall be initialised with

$$c_{\text{init}} = n_{\text{RNTI}} \cdot 2^{14} + q \cdot 2^{13} + [(j_0 + j)N_{\text{acc}} \bmod 10] \cdot 2^9 + N_{\text{ID}}^{\text{cell}}$$

where

$$j = 0, 1, \dots, \left\lfloor \frac{i_0 + N_{\text{abs}}^{\text{PDSCH}} + i_{\Delta} - 1}{N_{\text{acc}}} \right\rfloor - j_0$$

$$j_0 = \lfloor (i_0 + i_{\Delta}) / N_{\text{acc}} \rfloor$$

$$i_{\Delta} = \begin{cases} 0, & \text{for frame structure type 1 or } N_{\text{acc}} = 1 \\ N_{\text{acc}} - 2, & \text{for frame structure type 2 and } N_{\text{acc}} = 10 \end{cases}$$

and i_0 is the absolute subframe number of the first downlink subframe intended for PDSCH. The PDSCH transmission spans $N_{\text{abs}}^{\text{PDSCH}}$ consecutive subframes including subframes that are not BL/CE DL subframes where the PDSCH transmission is postponed.

For BL/CE UEs,

- if the PDSCH is carrying SIB1-BR

- $N_{\text{acc}} = 1$
- else if the PDSCH is carrying SI message (except for SIB1-BR) or if the PDSCH transmission is associated with P-RNTI or SC-RNTI:
 - $N_{\text{acc}} = 4$ for frame structure type 1 and $N_{\text{acc}} = 10$ for frame structure type 2
- otherwise
 - $N_{\text{acc}} = 1$ for UEs assuming CEModeA (according to the definition in Clause 12 of [4]) or configured with CEModeA
 - $N_{\text{acc}} = 4$ for frame structure type 1 and $N_{\text{acc}} = 10$ for frame structure type 2 for UEs assuming CEModeB (according to the definition in Clause 12 of [4]) or configured with CEModeB

For PDSCH with a subframe duration, up to two codewords can be transmitted in one subframe, i.e., $q \in \{0,1\}$. In the case of single codeword transmission, q is equal to zero.

6.3.2 Modulation

For each codeword q , the block of scrambled bits $\tilde{b}^{(q)}(0), \dots, \tilde{b}^{(q)}(M_{\text{bit}}^{(q)} - 1)$ shall be modulated as described in clause 7.1 using one of the modulation schemes in Table 6.3.2-1, resulting in a block of complex-valued modulation symbols $d^{(q)}(0), \dots, d^{(q)}(M_{\text{symp}}^{(q)} - 1)$.

Table 6.3.2-1: Modulation schemes

Physical channel	Modulation schemes
PDSCH	QPSK, 16QAM, 64QAM, 256QAM
PMCH	QPSK, 16QAM, 64QAM, 256QAM

6.3.3 Layer mapping

The complex-valued modulation symbols for each of the codewords to be transmitted are mapped onto one or several layers. Complex-valued modulation symbols $d^{(q)}(0), \dots, d^{(q)}(M_{\text{symp}}^{(q)} - 1)$ for codeword q shall be mapped onto the layers $x(i) = [x^{(0)}(i) \ \dots \ x^{(v-1)}(i)]^T$, $i = 0, 1, \dots, M_{\text{symp}}^{\text{layer}} - 1$ where v is the number of layers and $M_{\text{symp}}^{\text{layer}}$ is the number of modulation symbols per layer, unless $v = 2$ and "MUST interference presence and power ratio (*MUSTIdx*)" signalled in the associated DCI is '00' for only one codeword in which case $x(i) = [\alpha^{(0)}x^{(0)}(i) \ \alpha^{(1)}x^{(1)}(i)]^T$, where $\alpha^{(j)} = \sqrt{\frac{2(1-\beta)}{2-\beta}}$ for the layer j for which *MUSTIdx* is '00', and $\alpha^{(j)} = \sqrt{\frac{2}{2-\beta}}$ for the layer j for which *MUSTIdx* is not '00'. The value of β is determined from Table 6.3.3-1 using *MUSTIdx* and the modulation order of the codeword for which *MUSTIdx* is not '00'.

Table 6.3.3-1: Values for β

<i>MUSTIdx</i>	<i>Modulation order</i>		
	QPSK	16QAM	64QAM
01	8/10	32/42	128/170
10	50/58	144.5/167	40.5/51
11	264.5/289	128/138	288/330

6.3.3.1 Layer mapping for transmission on a single antenna port

For transmission on a single antenna port, a single layer is used, $v = 1$, and the mapping is defined by

$$x^{(0)}(i) = d^{(0)}(i)$$

with $M_{\text{symb}}^{\text{layer}} = M_{\text{symb}}^{(0)}$.

6.3.3.2 Layer mapping for spatial multiplexing

For spatial multiplexing, the layer mapping shall be done according to Table 6.3.3.2-1. The number of layers ν is less than or equal to the number of antenna ports P used for transmission of the physical channel. The case of a single codeword mapped to multiple layers is only applicable when the number of cell-specific reference signals is four or when the number of UE-specific reference signals is two or larger. For subslot/slot-PDSCH, the number of codewords is always one.

Table 6.3.3.2-1: Codeword-to-layer mapping for spatial multiplexing

Number of layers	Number of codewords	Codeword-to-layer mapping $i = 0, 1, \dots, M_{\text{symb}}^{\text{layer}} - 1$
1	1	$x^{(0)}(i) = d^{(0)}(i)$ $M_{\text{symb}}^{\text{layer}} = M_{\text{symb}}^{(0)}$
2	1	$x^{(0)}(i) = d^{(0)}(2i)$ $x^{(1)}(i) = d^{(0)}(2i+1)$ $M_{\text{symb}}^{\text{layer}} = M_{\text{symb}}^{(0)} / 2$
2	2	$x^{(0)}(i) = d^{(0)}(i)$ $x^{(1)}(i) = d^{(1)}(i)$ $M_{\text{symb}}^{\text{layer}} = M_{\text{symb}}^{(0)} = M_{\text{symb}}^{(1)}$
3	1	$x^{(0)}(i) = d^{(0)}(3i)$ $x^{(1)}(i) = d^{(0)}(3i+1)$ $x^{(2)}(i) = d^{(0)}(3i+2)$ $M_{\text{symb}}^{\text{layer}} = M_{\text{symb}}^{(0)} / 3$
3	2	$x^{(0)}(i) = d^{(0)}(i)$ $x^{(1)}(i) = d^{(1)}(2i)$ $x^{(2)}(i) = d^{(1)}(2i+1)$ $M_{\text{symb}}^{\text{layer}} = M_{\text{symb}}^{(0)} = M_{\text{symb}}^{(1)} / 2$
4	1	$x^{(0)}(i) = d^{(0)}(4i)$ $x^{(1)}(i) = d^{(0)}(4i+1)$ $x^{(2)}(i) = d^{(0)}(4i+2)$ $x^{(3)}(i) = d^{(0)}(4i+3)$ $M_{\text{symb}}^{\text{layer}} = M_{\text{symb}}^{(0)} / 4$
4	2	$x^{(0)}(i) = d^{(0)}(2i)$ $x^{(1)}(i) = d^{(0)}(2i+1)$ $x^{(2)}(i) = d^{(1)}(2i)$ $x^{(3)}(i) = d^{(1)}(2i+1)$ $M_{\text{symb}}^{\text{layer}} = M_{\text{symb}}^{(0)} / 2 = M_{\text{symb}}^{(1)} / 2$
5	2	$x^{(0)}(i) = d^{(0)}(2i)$ $x^{(1)}(i) = d^{(0)}(2i+1)$ $x^{(2)}(i) = d^{(1)}(3i)$ $x^{(3)}(i) = d^{(1)}(3i+1)$ $x^{(4)}(i) = d^{(1)}(3i+2)$ $M_{\text{symb}}^{\text{layer}} = M_{\text{symb}}^{(0)} / 2 = M_{\text{symb}}^{(1)} / 3$
6	2	$x^{(0)}(i) = d^{(0)}(3i)$ $x^{(1)}(i) = d^{(0)}(3i+1)$ $x^{(2)}(i) = d^{(0)}(3i+2)$ $x^{(3)}(i) = d^{(1)}(3i)$ $x^{(4)}(i) = d^{(1)}(3i+1)$ $x^{(5)}(i) = d^{(1)}(3i+2)$ $M_{\text{symb}}^{\text{layer}} = M_{\text{symb}}^{(0)} / 3 = M_{\text{symb}}^{(1)} / 3$

7	2	$x^{(0)}(i) = d^{(0)}(3i)$ $x^{(1)}(i) = d^{(0)}(3i + 1)$ $x^{(2)}(i) = d^{(0)}(3i + 2)$ $x^{(3)}(i) = d^{(1)}(4i)$ $x^{(4)}(i) = d^{(1)}(4i + 1)$ $x^{(5)}(i) = d^{(1)}(4i + 2)$ $x^{(6)}(i) = d^{(1)}(4i + 3)$	$M_{\text{symp}}^{\text{layer}} = M_{\text{symp}}^{(0)} / 3 = M_{\text{symp}}^{(1)} / 4$
8	2	$x^{(0)}(i) = d^{(0)}(4i)$ $x^{(1)}(i) = d^{(0)}(4i + 1)$ $x^{(2)}(i) = d^{(0)}(4i + 2)$ $x^{(3)}(i) = d^{(0)}(4i + 3)$ $x^{(4)}(i) = d^{(1)}(4i)$ $x^{(5)}(i) = d^{(1)}(4i + 1)$ $x^{(6)}(i) = d^{(1)}(4i + 2)$ $x^{(7)}(i) = d^{(1)}(4i + 3)$	$M_{\text{symp}}^{\text{layer}} = M_{\text{symp}}^{(0)} / 4 = M_{\text{symp}}^{(1)} / 4$

6.3.3.3 Layer mapping for transmit diversity

For transmit diversity, the layer mapping shall be done according to Table 6.3.3.3-1. There is only one codeword and the number of layers v is equal to the number of antenna ports P used for transmission of the physical channel.

Table 6.3.3.3-1: Codeword-to-layer mapping for transmit diversity

Number of layers	Number of codewords	Codeword-to-layer mapping	
		$i = 0, 1, \dots, M_{\text{symp}}^{\text{layer}} - 1$	
2	1	$x^{(0)}(i) = d^{(0)}(2i)$ $x^{(1)}(i) = d^{(0)}(2i + 1)$	$M_{\text{symp}}^{\text{layer}} = M_{\text{symp}}^{(0)} / 2$
4	1	$x^{(0)}(i) = d^{(0)}(4i)$ $x^{(1)}(i) = d^{(0)}(4i + 1)$ $x^{(2)}(i) = d^{(0)}(4i + 2)$ $x^{(3)}(i) = d^{(0)}(4i + 3)$	$M_{\text{symp}}^{\text{layer}} = \begin{cases} M_{\text{symp}}^{(0)} / 4 & \text{if } M_{\text{symp}}^{(0)} \bmod 4 = 0 \\ (M_{\text{symp}}^{(0)} + 2) / 4 & \text{if } M_{\text{symp}}^{(0)} \bmod 4 \neq 0 \end{cases}$ If $M_{\text{symp}}^{(0)} \bmod 4 \neq 0$ two null symbols shall be appended to $d^{(0)}(M_{\text{symp}}^{(0)} - 1)$

6.3.4 Precoding

The precoder takes as input a block of vectors $x(i) = [x^{(0)}(i) \ \dots \ x^{(v-1)}(i)]^T$, $i = 0, 1, \dots, M_{\text{symp}}^{\text{layer}} - 1$ from the layer mapping and generates a block of vectors $y(i) = [\dots \ y^{(p)}(i) \ \dots]^T$, $i = 0, 1, \dots, M_{\text{symp}}^{\text{ap}} - 1$ to be mapped onto resources on each of the antenna ports, where $y^{(p)}(i)$ represents the signal for antenna port p .

6.3.4.1 Precoding for transmission on a single antenna port

For transmission on a single antenna port, precoding is defined by

$$y^{(p)}(i) = x^{(0)}(i)$$

where $p \in \{0, 4, 5, 7, 8, 11, 13, 107, 108, 109, 110\}$ is the number of the single antenna port used for transmission of the

physical channel and $i = 0, 1, \dots, M_{\text{symb}}^{\text{ap}} - 1$, $M_{\text{symb}}^{\text{ap}} = M_{\text{symb}}^{\text{layer}}$.

6.3.4.2 Precoding for spatial multiplexing using antenna ports with cell-specific reference signals

Precoding for spatial multiplexing using antenna ports with cell-specific reference signals is only used in combination with layer mapping for spatial multiplexing as described in clause 6.3.3.2. Spatial multiplexing supports two or four antenna ports and the set of antenna ports used is $p \in \{0,1\}$ or $p \in \{0,1,2,3\}$, respectively.

6.3.4.2.1 Precoding without CDD

Without Cyclic Delay Diversity (CDD), precoding for spatial multiplexing is defined by

$$\begin{bmatrix} y^{(0)}(i) \\ \vdots \\ y^{(P-1)}(i) \end{bmatrix} = W(i) \begin{bmatrix} x^{(0)}(i) \\ \vdots \\ x^{(v-1)}(i) \end{bmatrix}$$

where the precoding matrix $W(i)$ is of size $P \times v$ and $i = 0, 1, \dots, M_{\text{symb}}^{\text{ap}} - 1$, $M_{\text{symb}}^{\text{ap}} = M_{\text{symb}}^{\text{layer}}$.

For spatial multiplexing, the values of $W(i)$ shall be selected among the precoder elements in the codebook configured in the eNodeB and the UE. The eNodeB can further confine the precoder selection in the UE to a subset of the elements in the codebook using codebook subset restrictions. The configured codebook shall be selected from Table 6.3.4.2.3-1 or 6.3.4.2.3-2.

6.3.4.2.2 Precoding for large delay CDD

For large-delay CDD, precoding for spatial multiplexing is defined by

$$\begin{bmatrix} y^{(0)}(i) \\ \vdots \\ y^{(P-1)}(i) \end{bmatrix} = W(i)D(i)U \begin{bmatrix} x^{(0)}(i) \\ \vdots \\ x^{(v-1)}(i) \end{bmatrix}$$

where the precoding matrix $W(i)$ is of size $P \times v$ and $i = 0, 1, \dots, M_{\text{symb}}^{\text{ap}} - 1$, $M_{\text{symb}}^{\text{ap}} = M_{\text{symb}}^{\text{layer}}$. The diagonal size- $v \times v$ matrix $D(i)$ supporting cyclic delay diversity and the size- $v \times v$ matrix U are both given by Table 6.3.4.2.2-1 for different numbers of layers v .

The values of the precoding matrix $W(i)$ shall be selected among the precoder elements in the codebook configured in the eNodeB and the UE. The eNodeB can further confine the precoder selection in the UE to a subset of the elements in the codebook using codebook subset restriction. The configured codebook shall be selected from Table 6.3.4.2.3-1 or 6.3.4.2.3-2.

For 2 antenna ports, the precoder is selected according to $W(i) = C_1$ where C_1 denotes the precoding matrix corresponding to precoder index 0 in Table 6.3.4.2.3-1.

For 4 antenna ports, the UE may assume that the eNodeB cyclically assigns different precoders to different vectors $\begin{bmatrix} x^{(0)}(i) & \dots & x^{(v-1)}(i) \end{bmatrix}^T$ on the physical downlink shared channel as follows. A different precoder is used every v vectors, where v denotes the number of transmission layers in the case of spatial multiplexing. In particular, the

precoder is selected according to $W(i) = C_k$, where k is the precoder index given by $k = \left(\left\lfloor \frac{i}{v} \right\rfloor \bmod 4 \right) + 1 \in \{1, 2, 3, 4\}$

and C_1, C_2, C_3, C_4 denote precoder matrices corresponding to precoder indices 12, 13, 14 and 15, respectively, in Table 6.3.4.2.3-2.

Table 6.3.4.2.2-1: Large-delay cyclic delay diversity

Number of layers v	U	$D(i)$
2	$\frac{1}{\sqrt{2}} \begin{bmatrix} 1 & 1 \\ 1 & e^{-j2\pi/2} \end{bmatrix}$	$\begin{bmatrix} 1 & 0 \\ 0 & e^{-j2\pi/2} \end{bmatrix}$
3	$\frac{1}{\sqrt{3}} \begin{bmatrix} 1 & 1 & 1 \\ 1 & e^{-j2\pi/3} & e^{-j4\pi/3} \\ 1 & e^{-j4\pi/3} & e^{-j8\pi/3} \end{bmatrix}$	$\begin{bmatrix} 1 & 0 & 0 \\ 0 & e^{-j2\pi/3} & 0 \\ 0 & 0 & e^{-j4\pi/3} \end{bmatrix}$
4	$\frac{1}{2} \begin{bmatrix} 1 & 1 & 1 & 1 \\ 1 & e^{-j2\pi/4} & e^{-j4\pi/4} & e^{-j6\pi/4} \\ 1 & e^{-j4\pi/4} & e^{-j8\pi/4} & e^{-j12\pi/4} \\ 1 & e^{-j6\pi/4} & e^{-j12\pi/4} & e^{-j18\pi/4} \end{bmatrix}$	$\begin{bmatrix} 1 & 0 & 0 & 0 \\ 0 & e^{-j2\pi/4} & 0 & 0 \\ 0 & 0 & e^{-j4\pi/4} & 0 \\ 0 & 0 & 0 & e^{-j6\pi/4} \end{bmatrix}$

6.3.4.2.3 Codebook for precoding and CSI reporting

For transmission on two antenna ports, $p \in \{0,1\}$, and for the purpose of CSI reporting based on two antenna ports $p \in \{0,1\}$ or $p \in \{15,16\}$, the precoding matrix $W(i)$ shall be selected from Table 6.3.4.2.3-1 or a subset thereof. For the closed-loop spatial multiplexing transmission mode defined in 3GPP TS 36.213 [4], the codebook index 0 is not used when the number of layers is $v = 2$.

Table 6.3.4.2.3-1: Codebook for transmission on antenna ports $\{0,1\}$ and for CSI reporting based on antenna ports $\{0,1\}$ or $\{15,16\}$

Codebook index	Number of layers v	
	1	2
0	$\frac{1}{\sqrt{2}} \begin{bmatrix} 1 \\ 1 \end{bmatrix}$	$\frac{1}{\sqrt{2}} \begin{bmatrix} 1 & 0 \\ 0 & 1 \end{bmatrix}$
1	$\frac{1}{\sqrt{2}} \begin{bmatrix} 1 \\ -1 \end{bmatrix}$	$\frac{1}{2} \begin{bmatrix} 1 & 1 \\ 1 & -1 \end{bmatrix}$
2	$\frac{1}{\sqrt{2}} \begin{bmatrix} 1 \\ j \end{bmatrix}$	$\frac{1}{2} \begin{bmatrix} 1 & 1 \\ j & -j \end{bmatrix}$
3	$\frac{1}{\sqrt{2}} \begin{bmatrix} 1 \\ -j \end{bmatrix}$	-

For transmission on four antenna ports, $p \in \{0,1,2,3\}$, the precoding matrix W shall be selected from Table 6.3.4.2.3-2 or a subset thereof. For the purpose of CSI reporting based on four antenna ports $p \in \{0,1,2,3\}$ or $p \in \{15,16,17,18\}$, the precoding matrix W shall be selected from Table 6.3.4.2.3-2 or a subset thereof except for *alternativeCodeBookEnabledFor4TX-r12 = TRUE* in which case the precoding matrix W shall be selected from Tables 7.2.4-0A, 7.2.4-0B, 7.2.4-0C, 7.2.4-0D in [4] or a subset thereof, and except for *advancedCodebookEnabled = TRUE* in which case the precoding matrix W shall be selected from Table 7.2.4-17C in [4] or a subset thereof. The quantity $W_n^{(s)}$ denotes the matrix defined by the columns given by the set $\{s\}$ from the expression $W_n = I - 2u_n u_n^H / u_n^H u_n$ where I is the 4×4 identity matrix and the vector u_n is given by Table 6.3.4.2.3-2.

Table 6.3.4.2.3-2: Codebook for transmission on antenna ports $\{0,1,2,3\}$ and for CSI reporting based on antenna ports $\{0,1,2,3\}$ or $\{15,16,17,18\}$

Codebook index	u_n	Number of layers v			
		1	2	3	4
0	$u_0 = [1 \ -1 \ -1 \ -1]^T$	$W_0^{(1)}$	$W_0^{(14)} / \sqrt{2}$	$W_0^{(124)} / \sqrt{3}$	$W_0^{(1234)} / 2$

1	$u_1 = [1 \ -j \ 1 \ j]^T$	$W_1^{(1)}$	$W_1^{(12)}/\sqrt{2}$	$W_1^{(123)}/\sqrt{3}$	$W_1^{(1234)}/2$
2	$u_2 = [1 \ 1 \ -1 \ 1]^T$	$W_2^{(1)}$	$W_2^{(12)}/\sqrt{2}$	$W_2^{(123)}/\sqrt{3}$	$W_2^{(3214)}/2$
3	$u_3 = [1 \ j \ 1 \ -j]^T$	$W_3^{(1)}$	$W_3^{(12)}/\sqrt{2}$	$W_3^{(123)}/\sqrt{3}$	$W_3^{(3214)}/2$
4	$u_4 = [1 \ (-1-j)/\sqrt{2} \ -j \ (1-j)/\sqrt{2}]^T$	$W_4^{(1)}$	$W_4^{(14)}/\sqrt{2}$	$W_4^{(124)}/\sqrt{3}$	$W_4^{(1234)}/2$
5	$u_5 = [1 \ (1-j)/\sqrt{2} \ j \ (-1-j)/\sqrt{2}]^T$	$W_5^{(1)}$	$W_5^{(14)}/\sqrt{2}$	$W_5^{(124)}/\sqrt{3}$	$W_5^{(1234)}/2$
6	$u_6 = [1 \ (1+j)/\sqrt{2} \ -j \ (-1+j)/\sqrt{2}]^T$	$W_6^{(1)}$	$W_6^{(13)}/\sqrt{2}$	$W_6^{(134)}/\sqrt{3}$	$W_6^{(1324)}/2$
7	$u_7 = [1 \ (-1+j)/\sqrt{2} \ j \ (1+j)/\sqrt{2}]^T$	$W_7^{(1)}$	$W_7^{(13)}/\sqrt{2}$	$W_7^{(134)}/\sqrt{3}$	$W_7^{(1324)}/2$
8	$u_8 = [1 \ -1 \ 1 \ 1]^T$	$W_8^{(1)}$	$W_8^{(12)}/\sqrt{2}$	$W_8^{(124)}/\sqrt{3}$	$W_8^{(1234)}/2$
9	$u_9 = [1 \ -j \ -1 \ -j]^T$	$W_9^{(1)}$	$W_9^{(14)}/\sqrt{2}$	$W_9^{(134)}/\sqrt{3}$	$W_9^{(1234)}/2$
10	$u_{10} = [1 \ 1 \ 1 \ -1]^T$	$W_{10}^{(1)}$	$W_{10}^{(13)}/\sqrt{2}$	$W_{10}^{(123)}/\sqrt{3}$	$W_{10}^{(1324)}/2$
11	$u_{11} = [1 \ j \ -1 \ j]^T$	$W_{11}^{(1)}$	$W_{11}^{(13)}/\sqrt{2}$	$W_{11}^{(134)}/\sqrt{3}$	$W_{11}^{(1324)}/2$
12	$u_{12} = [1 \ -1 \ -1 \ 1]^T$	$W_{12}^{(1)}$	$W_{12}^{(12)}/\sqrt{2}$	$W_{12}^{(123)}/\sqrt{3}$	$W_{12}^{(1234)}/2$
13	$u_{13} = [1 \ -1 \ 1 \ -1]^T$	$W_{13}^{(1)}$	$W_{13}^{(13)}/\sqrt{2}$	$W_{13}^{(123)}/\sqrt{3}$	$W_{13}^{(1324)}/2$
14	$u_{14} = [1 \ 1 \ -1 \ -1]^T$	$W_{14}^{(1)}$	$W_{14}^{(13)}/\sqrt{2}$	$W_{14}^{(123)}/\sqrt{3}$	$W_{14}^{(3214)}/2$
15	$u_{15} = [1 \ 1 \ 1 \ 1]^T$	$W_{15}^{(1)}$	$W_{15}^{(12)}/\sqrt{2}$	$W_{15}^{(123)}/\sqrt{3}$	$W_{15}^{(1234)}/2$

For the purpose of CSI reporting for 8, 12, 16, 20, 24, 28, and 32 CSI reference signals the codebooks are given in clause 7.2.4 of 3GPP TS 36.213 [4].

6.3.4.3 Precoding for transmit diversity

Precoding for transmit diversity is only used in combination with layer mapping for transmit diversity as described in clause 6.3.3.3. The precoding operation for transmit diversity is defined for two and four antenna ports.

For transmission on two antenna ports, $p \in \{0,1\}$, the output $y(i) = [y^{(0)}(i) \ y^{(1)}(i)]^T$, $i = 0,1,\dots,M_{\text{symp}}^{\text{ap}} - 1$ of the precoding operation is defined by

$$\begin{bmatrix} y^{(0)}(2i) \\ y^{(1)}(2i) \\ y^{(0)}(2i+1) \\ y^{(1)}(2i+1) \end{bmatrix} = \frac{1}{\sqrt{2}} \begin{bmatrix} 1 & 0 & j & 0 \\ 0 & -1 & 0 & j \\ 0 & 1 & 0 & j \\ 1 & 0 & -j & 0 \end{bmatrix} \begin{bmatrix} \text{Re}(x^{(0)}(i)) \\ \text{Re}(x^{(1)}(i)) \\ \text{Im}(x^{(0)}(i)) \\ \text{Im}(x^{(1)}(i)) \end{bmatrix}$$

for $i = 0,1,\dots,M_{\text{symp}}^{\text{layer}} - 1$ with $M_{\text{symp}}^{\text{ap}} = 2M_{\text{symp}}^{\text{layer}}$.

For rank=1 transmission on two antenna ports, $p \in \{7,8\}$, the output $y(i) = [y^{(7)}(i) \ y^{(8)}(i)]^T$, $i = 0,1,\dots,M_{\text{symp}}^{\text{ap}} - 1$ of the precoding operation is defined by

$$\begin{bmatrix} y^{(\bar{p})}(2i) \\ y^{(\bar{p}+1)}(2i) \\ y^{(\bar{p})}(2i+1) \\ y^{(\bar{p}+1)}(2i+1) \end{bmatrix} = \begin{bmatrix} 1 & j & 0 & 0 \\ 0 & 0 & -1 & j \\ 0 & 0 & 1 & j \\ 1 & -j & 0 & 0 \end{bmatrix} \begin{bmatrix} \text{Re}(x^{(0)}(i)) \\ \text{Im}(x^{(0)}(i)) \\ \text{Re}(x^{(1)}(i)) \\ \text{Im}(x^{(1)}(i)) \end{bmatrix}$$

where $\bar{p} = 7$.

For transmission on four antenna ports, $p \in \{0,1,2,3\}$, the output $y(i) = [y^{(0)}(i) \ y^{(1)}(i) \ y^{(2)}(i) \ y^{(3)}(i)]^T$,

$i = 0, 1, \dots, M_{\text{symb}}^{\text{ap}} - 1$ of the precoding operation is defined by

$$\begin{bmatrix} y^{(0)}(4i) \\ y^{(1)}(4i) \\ y^{(2)}(4i) \\ y^{(3)}(4i) \\ y^{(0)}(4i+1) \\ y^{(1)}(4i+1) \\ y^{(2)}(4i+1) \\ y^{(3)}(4i+1) \\ y^{(0)}(4i+2) \\ y^{(1)}(4i+2) \\ y^{(2)}(4i+2) \\ y^{(3)}(4i+2) \\ y^{(0)}(4i+3) \\ y^{(1)}(4i+3) \\ y^{(2)}(4i+3) \\ y^{(3)}(4i+3) \end{bmatrix} = \frac{1}{\sqrt{2}} \begin{bmatrix} 1 & 0 & 0 & 0 & j & 0 & 0 & 0 \\ 0 & 0 & 0 & 0 & 0 & 0 & 0 & 0 \\ 0 & -1 & 0 & 0 & 0 & j & 0 & 0 \\ 0 & 0 & 0 & 0 & 0 & 0 & 0 & 0 \\ 0 & 1 & 0 & 0 & 0 & j & 0 & 0 \\ 0 & 0 & 0 & 0 & 0 & 0 & 0 & 0 \\ 1 & 0 & 0 & 0 & -j & 0 & 0 & 0 \\ 0 & 0 & 0 & 0 & 0 & 0 & 0 & 0 \\ 0 & 0 & 0 & 0 & 0 & 0 & 0 & 0 \\ 0 & 0 & 1 & 0 & 0 & 0 & j & 0 \\ 0 & 0 & 0 & 0 & 0 & 0 & 0 & 0 \\ 0 & 0 & 0 & -1 & 0 & 0 & 0 & j \\ 0 & 0 & 0 & 0 & 0 & 0 & 0 & 0 \\ 0 & 0 & 0 & 1 & 0 & 0 & 0 & j \\ 0 & 0 & 0 & 0 & 0 & 0 & 0 & 0 \\ 0 & 0 & 1 & 0 & 0 & 0 & -j & 0 \end{bmatrix} \begin{bmatrix} \text{Re}\{x^{(0)}(i)\} \\ \text{Re}\{x^{(1)}(i)\} \\ \text{Re}\{x^{(2)}(i)\} \\ \text{Re}\{x^{(3)}(i)\} \\ \text{Im}\{x^{(0)}(i)\} \\ \text{Im}\{x^{(1)}(i)\} \\ \text{Im}\{x^{(2)}(i)\} \\ \text{Im}\{x^{(3)}(i)\} \end{bmatrix}$$

for $i = 0, 1, \dots, M_{\text{symb}}^{\text{layer}} - 1$ with $M_{\text{symb}}^{\text{ap}} = \begin{cases} 4M_{\text{symb}}^{\text{layer}} & \text{if } M_{\text{symb}}^{(0)} \bmod 4 = 0 \\ (4M_{\text{symb}}^{\text{layer}}) - 2 & \text{if } M_{\text{symb}}^{(0)} \bmod 4 \neq 0 \end{cases}$.

6.3.4.4 Precoding for spatial multiplexing using antenna ports with UE-specific reference signals

Precoding for spatial multiplexing using antenna ports with UE-specific reference signals is only used in combination with layer mapping for spatial multiplexing as described in clause 6.3.3.2. Spatial multiplexing using antenna ports with UE-specific reference signals supports up to eight antenna ports.

If the higher-layer parameter *dmrs-tableAlt* is set to TRUE and the set of antenna ports $p = \{11, 13\}$ is used for two layers transmission, the precoding operation for transmission on the two antenna ports is defined by

$$\begin{bmatrix} y^{(11)}(i) \\ y^{(13)}(i) \end{bmatrix} = \begin{bmatrix} x^{(0)}(i) \\ x^{(1)}(i) \end{bmatrix}$$

where $i = 0, 1, \dots, M_{\text{symb}}^{\text{ap}} - 1$, $M_{\text{symb}}^{\text{ap}} = M_{\text{symb}}^{\text{layer}}$.

If the higher-layer parameter *semiOpenLoop* is set to TRUE for subframe PDSCH or the higher-layer parameter *semiOpenLoop-STTI* is set to TRUE for slot/subslot PDSCH and the set of antenna ports $p = 7, 8$ is used for rank=2 transmission, the precoding operation for transmission on the two antenna ports is defined by

$$\begin{bmatrix} y^{(\bar{p})}(i) \\ y^{(\bar{p}+1)}(i) \end{bmatrix} = \frac{1}{\sqrt{2}} \begin{bmatrix} 1 & j & 1 & j \\ e^{j\theta_n} & je^{j\theta_n} & -e^{j\theta_n} & -je^{j\theta_n} \end{bmatrix} \begin{bmatrix} \text{Re}\{x^{(0)}(0)\} \\ \text{Im}\{x^{(0)}(0)\} \\ \text{Re}\{x^{(1)}(0)\} \\ \text{Im}\{x^{(1)}(0)\} \end{bmatrix}$$

where $\bar{p} = 7$ and $\theta_n = \pi(i \bmod 2)/2$.

If the number of codewords is two and the DCI associated with the scheduled PDSCH is of Format 2D and the 'PDSCH RE Mapping and Quasi-Co-Location indicator' field in the DCI indicates a higher-layer configured PDSCH-RE-MappingQCL containing two sets of parameters, the precoding operation for transmission on v antenna ports is defined by

$$\begin{bmatrix} y^{(p_0)}(i) \\ \vdots \\ y^{(p_{v-1})}(i) \end{bmatrix} = \begin{bmatrix} x^{(0)}(i) \\ \vdots \\ x^{(v-1)}(i) \end{bmatrix}$$

where $i = 0, 1, \dots, M_{\text{symb}}^{\text{ap}} - 1$, $M_{\text{symb}}^{\text{ap}} = M_{\text{symb}}^{\text{layer}}$ and set of antenna ports p_j used is given by Table 6.3.4.4-1.

Table 6.3.4.4-1: Layer-to-port mapping for two-codeword transmission when PDSCH-RE-MappingQCL contains two sets of parameters

Number of layers v	Layer-to-port mapping $[p_0 \ \dots \ p_{v-1}]$
2	[7 8]
3	[7 9 10]
4	[7 8 9 10]
5	[7 8 9 10 12]
6	[7 8 11 9 10 12]
7	[7 8 11 9 10 12 14]
8	[7 8 11 13 9 10 12 14]

Otherwise, the set of antenna ports used is $p = 7, 8, \dots, v+6$ and the precoding operation for transmission on v antenna ports is defined by

$$\begin{bmatrix} y^{(7)}(i) \\ y^{(8)}(i) \\ \vdots \\ y^{(6+v)}(i) \end{bmatrix} = \begin{bmatrix} x^{(0)}(i) \\ x^{(1)}(i) \\ \vdots \\ x^{(v-1)}(i) \end{bmatrix}$$

where $i = 0, 1, \dots, M_{\text{symb}}^{\text{ap}} - 1$, $M_{\text{symb}}^{\text{ap}} = M_{\text{symb}}^{\text{layer}}$.

6.3.5 Mapping to resource elements

For each of the antenna ports used for transmission of the physical channel, the block of complex-valued symbols $y^{(p)}(0), \dots, y^{(p)}(M_{\text{symb}}^{\text{ap}} - 1)$ shall conform to the downlink power allocation specified in clause 5.2 in

3GPP TS 36.213 [4] and be mapped in sequence starting with $y^{(p)}(0)$ to resource elements (k, l) which meet all of the following criteria in the current subframe:

- they are in the physical resource blocks corresponding to the virtual resource blocks assigned for transmission, and
- they are not used for transmission of the core part of PBCH, synchronization signals, and
- they are assumed by the UE not to be used for cell-specific reference signals, where the positions of the cell-specific reference signals are given by clause 6.10.1.2 with the number of antenna ports for and the frequency shift of cell-specific reference signals derived as described in clause 6.10.1.2 4, and

The mapping to resource elements (k, l) on antenna port p not reserved for other purposes shall be in increasing order of first the index k over the assigned physical resource blocks and then the index l , starting with the first slot in a subframe.

For BL/CE UEs, if the higher layer parameter *ce-punctured-subcarriers-DL* is configured, then in case of MPDCCH or PDSCH transmission associated with C-RNTI or SPS C-RNTI,

- The parameter *ce-punctured-subcarriers-DL* indicates the number of subcarriers (1 or 2) and their position (lower or higher edge) to puncture at the downlink narrowband edges:

- If the value is '00', then the number of punctured subcarriers on the higher edge of narrowbands above the DC subcarrier is 2 and the number of punctured subcarriers on the higher edge of narrowbands below the DC subcarrier is 1.
- If the value is '01', then the number of punctured subcarriers on the higher edge of narrowbands above the DC subcarrier is 1 and the number of punctured subcarriers on the higher edge of narrowbands below the DC subcarrier is 0.
- If the value is '10', then the number of punctured subcarriers on the lower edge of narrowbands above the DC subcarrier is 0 and the number of punctured subcarriers on the lower edge of narrowbands below the DC subcarrier is 1.
- If the value is '11', then the number of punctured subcarriers on the lower edge of narrowbands above the DC subcarrier is 1 and the number of punctured subcarriers on the lower edge of narrowbands below the DC subcarrier is 2.
- In the mapping to resource elements, when a subcarrier k is punctured according to the above, the resource elements (k,l) shall be counted but not used for transmission.
- The subcarrier puncturing is applied to transmission of the following physical signals and channels when the transmission is aligned with a narrowband edge.
 - MPDCCH
 - PDSCH
 - CSI reference signals
- No subcarrier puncturing is applied to transmissions that are not aligned with a narrowband edge.

6.4 Physical downlink shared channel

The physical downlink shared channel shall be processed and mapped to resource elements as described in clause 6.3 with the following additions and exceptions:

- In resource blocks in which UE-specific reference signals are not transmitted, the PDSCH shall be transmitted on the same set of antenna ports as the PBCH, which is one of $\{0\}$, $\{0,1\}$, or $\{0,1,2,3\}$.
- In resource blocks in which UE-specific reference signals are transmitted, the PDSCH shall be transmitted on antenna port(s) $\{5\}$, $\{7\}$, $\{8\}$, $\{11\}$, $\{13\}$, $\{11,13\}$, $p \in \{7,8,\dots,v+6\}$, or the antenna ports listed in Table 6.3.4.4-1, where v is the number of layers used for transmission of the PDSCH.
- If PDSCH is transmitted in MBSFN subframes as defined in 3GPP TS 36.213 [4], the PDSCH shall be transmitted on one or several of antenna port(s) $p \in \{7,8,\dots,v+6\}$ or on the antenna ports indicated in Table 6.3.4.4-1, where v is the number of layers used for transmission of the PDSCH.
- PDSCH is not mapped to resource elements used for UE-specific reference signals associated with PDSCH
- In mapping to resource elements, the same positions of the cell-specific reference shall be assumed for all antenna ports on which the PDSCH is transmitted and the positions of the cell-specific reference signals are given by clause 6.10.1.2 with the number of antenna ports and the frequency shift of the cell-specific reference signals derived as described in clause 6.10.1.2, unless indicated otherwise in clause 7.1.9 in 3GPP TS 36.213 [4],
 - if one set of parameters for cell-specific reference signal positions are provided by clause 7.1.9 in 3GPP TS 36.213 [4], the values of these parameters are used for all antenna ports whereon the PDSCH is transmitted in the resource blocks indicated by the relevant DCI.
 - if two sets of parameters for cell-specific reference signal positions are provided by clause 7.1.9 in 3GPP TS 36.213 [4], the first set of parameters are used for the set of antenna ports associated with PDSCH codeword $q = 0$ while the second set of parameters are used for the set of antenna ports associated with PDSCH codeword $q = 1$, according to codeword-to-layer mapping and layer-to-port mapping in Clause 6.3.3.2 and Clause 6.3.4.4, respectively.

- If the DCI associated with the PDSCH uses the C-RNTI or semi-persistent C-RNTI, PDSCH modulation symbols on the indicated antenna ports are not mapped to resource elements assumed by the UE to be used for transmission of:
 - zero-power CSI reference signals, where the positions of the CSI reference signals assumed for each antenna port are given by clause 6.10.5.2. The configuration for zero power CSI reference signals is
 - obtained as described in clause 6.10.5.2 and used for all antenna ports whereon the PDSCH is transmitted, unless indicated otherwise in clause 7.1.9 in 3GPP TS 36.213 [4]
 - if one set of parameters for zero power CSI reference signal configuration is provided by clause 7.1.9 in 3GPP TS 36.213 [4], the values of these parameters are used for all antenna ports on which the PDSCH is transmitted in the resource blocks indicated by the corresponding DCI scheduling the PDSCH, and
 - if two sets of parameters for zero power CSI reference signal configuration are provided by clause 7.1.9 in 3GPP TS 36.213 [4], the first set of parameters are used for the set of antenna ports associated with PDSCH codeword $q = 0$ while the second set of parameters are used for the set of antenna ports associated with PDSCH codeword $q = 1$, according to codeword-to-layer mapping and layer-to-port mapping in Clause 6.3.3.2 and Clause 6.3.4.4, respectively.
 - obtained by higher-layer configuration of up to five reserved CSI-RS resources as part of the discovery signal configuration following the procedure for zero-power CSI-RS in clause 6.10.5.2.
 - non-zero-power CSI reference signals for CSI reporting, except for non-zero power CSI reference signals configured by *csi-RS-ConfigNZP-APList*, where the positions of the non-zero-power CSI reference signals for CSI reporting are given by clause 6.10.5.2. The configuration for non-zero power CSI reference signals is obtained as described in clause 6.10.5.2.
- PDSCH is not mapped to any physical resource-block pair(s) carrying an EPDCCH associated with the PDSCH.
- PDSCH with subframe duration on antenna port 7, 8, 9, 10, 11, 12, 13 or 14 is not mapped to any physical resource-block pair(s) carrying PBCH or synchronization signals.
- Frame structure type 1, PDSCH on antenna port 5 is not mapped to any physical resource-block pair(s) carrying PBCH or synchronization signals.
- Frame structure type 2, PDSCH on antenna port 5 is not mapped to any physical resource-block pair(s) carrying PBCH.
- For frame structure type 1 and 2, the index l in the first slot in a subframe fulfils $l \geq l_{\text{DataStart}}$ where $l_{\text{DataStart}}$ is given by clause 7.1.6.4 of 3GPP TS 36.213 [4].
- For frame structure type 3,
 - if the higher layer parameter *subframeStartPosition* indicates 's07' and the downlink transmission starts in the second slot of a subframe
 - the index l in the second slot in a subframe fulfils $l \geq l_{\text{DataStart}}$ where $l_{\text{DataStart}}$ is given by clause 7.1.6.4 of 3GPP TS 36.213 [4],
 - otherwise
 - the index l in the first slot in a subframe fulfils $l \geq l_{\text{DataStart}}$ where $l_{\text{DataStart}}$ is given by clause 7.1.6.4 of 3GPP TS 36.213 [4],
- In mapping to resource elements, if the DCI associated with the PDSCH uses the C-RNTI or semi-persistent C-RNTI, and transmit diversity according to clause 6.3.4.3 is used, and if the higher-layer parameter *semiOpenLoop* is not set and if the DCI associated with the PDSCH is not of format 7, resource elements in an OFDM symbol assumed by the UE to contain CSI-RS shall be used in the mapping if and only if all of the following criteria are fulfilled:
 - there is an even number of resource elements for the OFDM symbol in each resource block assigned for transmission, and

- the complex-valued symbols $y^{(p)}(i)$ and $y^{(p)}(i+1)$, where i is an even number, can be mapped to resource elements (k,l) and $(k+n,l)$ in the same OFDM symbol with $n < 3$.
- In mapping to resource elements, if the DCI associated with the PDSCH uses C-RNTI or semi-persistent C-RNTI and if the higher-layer parameter *semiOpenLoop* is set for subframe PDSCH or the higher-layer parameter *semiOpenLoop-STTI* is set for slot/subslot PDSCH or if the DCI associated with the PDSCH is of format 7 and transmit diversity according to clause 6.3.4.3 is used, a pair of resource elements (k',l) , $(k'+n,l)$ shall be used in the mapping if and only if
 - the complex-valued symbols $y^{(p)}(i)$ and $y^{(p)}(i+1)$ can be mapped to resource elements (k',l) and $(k'+n,l)$ in the same OFDM symbol and the same PRB with $n < 3$, where i is an even number and k' starts from 0 at the lowest subcarrier of the PRB.

6.4.1 Physical downlink shared channel for BL/CE UEs

For BL/CE UEs, the following additions and exceptions hold in addition to those in clause 6.4:

- The maximum number of allocatable PRBs for PDSCH is restricted as follows:
 - If the PDSCH is associated with C-RNTI or SPS C-RNTI and the higher layer parameter *ce-pdsch-maxBandwidth-config* is set,
 - if the higher layer parameter *ce-pdsch-maxBandwidth-config* is set to 20 MHz, the maximum number of allocatable PRBs for PDSCH is 96 PRBs restricted to the narrowbands defined in clause 6.2.7;
 - if the higher layer parameter *ce-pdsch-maxBandwidth-config* is set to 5 MHz, the maximum number of allocatable PRBs for PDSCH is 24 PRBs restricted to no more than four of the narrowbands defined in clause 6.2.7.
 - If the PDSCH is associated with G-RNTI and the higher layer parameter *pdsch-MaxBandwidth-SC-MTCH* is set to 24 PRBs, the maximum number of allocatable PRBs for PDSCH is 24 PRBs restricted to no more than four of the narrowbands defined in clause 6.2.7.
 - For all other cases, the maximum number of allocatable PRBs for PDSCH is 6 PRBs restricted to one of the narrowbands defined in clause 6.2.7.
- Resource elements occupied by CSI reference signals shall be counted in the PDSCH mapping but not used for transmission of the PDSCH.
- Resource elements belonging to synchronization signals, the core part of PBCH, PBCH repetitions, or resource elements reserved for reference signals in the mapping operation of PBCH but not used for transmission of reference signals, shall be counted in the PDSCH mapping but not used for transmission of the PDSCH.
- PRB pairs occupied by RSS shall be counted in the PDSCH mapping but not used for transmission of the PDSCH.
- For BL/CE UEs in CEModeB configured in transmission mode 9, in MBSFN subframe(s), resource elements that correspond to the positions of cell-specific reference signals as in subframe #0 shall not be counted in the PDSCH mapping and not used for transmission of the PDSCH.
- Resource elements belonging to PRBs in which PRS is transmitted (including PRS muted subframes) shall be counted in the PDSCH mapping but not used for transmission of the PDSCH.
- If the higher layer parameter *ce-punctured-subcarriers-DL* is configured, and the DCI associated with the PDSCH uses C-RNTI or SPS C-RNTI, and transmit diversity according to clause 6.3.4.3 is used,
 - In the mapping to resource elements, when the complex-valued symbols $y^{(p)}(i)$ and $y^{(p)}(i+1)$, where i is an even number, are mapped to resource elements (k,l) and $(k+n,l)$ in the same OFDM symbol with $n < 3$, then if *ce-punctured-subcarriers-DL* indicates that any of (k,l) and $(k+n,l)$ shall be counted but not used for transmission, the UE shall assume that both (k,l) and $(k+n,l)$ are counted but not used for transmission.

- If PDSCH transmission in the LTE control region is configured by higher layer parameter *transmissionInControlChRegion*, after the initial mapping of the PDSCH to resource elements (k, l) starting from $l = l_{\text{DataStart}}$ in the first slot to the last OFDM symbol available for downlink transmission in the subframe has been performed, the mapping shall continue with resource elements (k, l) not reserved for cell-specific reference signals in increasing order of first the index k over the assigned physical resource blocks and then the index l starting from $l = 0$ in the first slot to $l = l_{\text{DataStart}} - 1$ in the first slot, where $l_{\text{DataStart}}$ is given by clause 7.1.6.4 of 3GPP TS 36.213 [4].

For BL/CE UEs, if the PDSCH is not carrying SIB1-BR the PRB resources for PDSCH transmission in the first subframe are obtained from the DCI as described in clauses 5.3.3.1.12, 5.3.3.1.13, and 5.5.1.3.14 in [3], or provided by higher layers. Each of the $N_{TB} \geq 1$ PDSCH codewords is transmitted with $N_{\text{rep}}^{\text{PDSCH}} \geq 1$ repetitions, where N_{TB} is the number of transport blocks defined in clause 7.1.11 of 3GPP TS 36.213 [4]. The PDSCH transmission spans $N_{\text{abs}}^{\text{PDSCH}} \geq N_{TB} N_{\text{rep}}^{\text{PDSCH}}$ consecutive subframes, including subframes that are not BL/CE DL subframes where the the PDSCH transmission is postponed.

- If higher layer parameter *resourceReservationDedicatedDL* is configured, and the Resource reservation field in the DCI is set to 1, then in case of PDSCH transmission associated with C-RNTI or SPS C-RNTI using UE-specific MPDCCH search space including PDSCH transmission without a corresponding MPDCCH,
 - In a subframe that is fully reserved as defined in clause 7.1 in [4], the PDSCH transmission is postponed until the next BL/CE downlink subframe that is not fully reserved.
 - In a subframe that is partially reserved, the reserved resource elements shall be counted in the PDSCH mapping but not used for transmission of the PDSCH.
- If frequency hopping is not enabled for PDSCH, all PDSCH repetitions are located at the same PRB resources, and
- if frequency hopping is enabled for PDSCH, the PDSCH shall be transmitted in subframe i within the $N_{\text{abs}}^{\text{PDSCH}}$ consecutive downlink subframes using the PRB resources of the narrowband $n_{\text{NB}}^{(i)}$ with the same RIV as that of narrowband $n_{\text{NB}}^{(i_0)}$. The narrowband $n_{\text{NB}}^{(i)}$ is defined as

$$n_{\text{NB}}^{(i)} = \left(n_{\text{NB}}^{(i_0)} + \left(\left\lfloor \frac{i + i_{\Delta}}{N_{\text{NB}}^{\text{ch,DL}}} - j_0 \right\rfloor \bmod N_{\text{NB,hop}}^{\text{ch,DL}} \right) \cdot f_{\text{NB,hop}}^{\text{DL}} \right) \bmod N_{\text{NB}}^{\text{DL}}$$

$$j_0 = \left\lfloor (i_0 + i_{\Delta}) / N_{\text{NB}}^{\text{ch,DL}} \right\rfloor$$

$$i_0 \leq i \leq i_0 + N_{\text{abs}}^{\text{PDSCH}} - 1$$

$$i_{\Delta} = \begin{cases} 0, & \text{for frame structure type 1} \\ N_{\text{NB}}^{\text{ch,DL}} - 2, & \text{for frame structure type 2} \end{cases}$$

where i_0 is the absolute subframe number of the first downlink subframe intended for PDSCH and $N_{\text{NB}}^{\text{ch,DL}}$, $N_{\text{NB,hop}}^{\text{ch,DL}}$ and $f_{\text{NB,hop}}^{\text{DL}}$ are cell-specific higher-layer parameters. For PDSCH carrying SI other than SIB1-BR and for PDSCH associated with P-RNTI, if *interval-DI Hopping Config Common Mode B* is signalled in SIB1-BR, then the frequency hopping granularity $N_{\text{NB}}^{\text{ch,DL}}$ is set to *interval-DI Hopping Config Common Mode B*; otherwise, $N_{\text{NB}}^{\text{ch,DL}}$ is set to *interval-DI Hopping Config Common Mode A* signalled in SIB1-BR.

For BL/CE UE in CEModeA, frequency hopping of PDSCH associated with C-RNTI or SPS C-RNTI is enabled when higher layer parameter *mpdcch-pdsch-HoppingConfig* is set and the frequency hopping flag in DCI format 6-1A indicates frequency hopping, otherwise, frequency hopping of is not enabled. For BL/CE UE in CEModeB, frequency hopping of PDSCH associated with C-RNTI or SPS C-RNTI is enabled when higher layer parameter *mpdcch-pdsch-HoppingConfig* is set, otherwise, frequency hopping of is not enabled.

The UE shall not expect PDSCH in subframe i if it is not a BL/CE DL subframe.

For BL/CE UEs, if the PDSCH carries SIB1-BR, the PDSCH transmission is repeated periodically in every period of 8 radio frames, where a period starts with a radio frame with $n_f \bmod 8 = 0$ where n_f is the system frame number. The PDSCH is transmitted $N_{\text{PDSCH}}^{\text{SIB1-BR}}$ times in each period of 8 frames, Let $\{s_j\}$ be the set of narrowbands, excluding

narrowbands overlapping with the 72 center subcarriers for $N_{RB}^{DL} > 15$, and ordered in increasing order of narrowband index. The PDSCH transmission cycles through the set $\{s_j\}$ of narrowbands in increasing order of i , starting with $i=0$ for the first subframe, according to

$$n_{NB} = s_j$$

$$j = \left(N_{ID}^{cell} \bmod N_{NB}^S + i \cdot \left\lfloor N_{NB}^S / m \right\rfloor \right) \bmod N_{NB}^S$$

$$i = 0, 1, \dots, m-1$$

$$m = \begin{cases} 1 & N_{RB}^{DL} < 12 \\ 2 & 12 \leq N_{RB}^{DL} \leq 50 \\ 4 & 50 < N_{RB}^{DL} \end{cases}$$

where N_{NB}^S is the number of narrowbands in the set $\{s_j\}$.

The set of frames and subframes used for SIB1-BR transmission in each period are given by Tables 6.4.1-1 and 6.4.1-2.

Table 6.4.1-1: The set of frames and subframes for SIB1-BR for $N_{RB}^{DL} \leq 15$.

$N_{SIB1-BR}^{PDSCH}$	$N_{ID}^{cell} \bmod 2$	Frame structure type 1		Frame structure type 2	
		$n_f \bmod 2$	n_{sf}	$n_f \bmod 2$	n_{sf}
4	0	0	4	1	5
	1	1	4	1	5

Table 6.4.1-2: The set of frames and subframes for SIB1-BR for $N_{RB}^{DL} > 15$.

$N_{SIB1-BR}^{PDSCH}$	$N_{ID}^{cell} \bmod 2$	Frame structure type 1		Frame structure type 2	
		$n_f \bmod 2$	n_{sf}	$n_f \bmod 2$	n_{sf}
4	0	0	4	1	5
	1	1	4	1	0
8	0	0, 1	4	0, 1	5
	1	0, 1	9	0, 1	0
16	0	0, 1	4, 9	0, 1	0, 5
	1	0, 1	0, 9	0, 1	0, 5

BL/CE UEs may assume the same precoding matrix being used for a PRB across a block of $N_{NB}^{ch,DL}$ consecutive subframes when UE-specific reference signals are transmitted together with the PDSCH, where the subframe number of the first subframe in each block of $N_{NB}^{ch,DL}$ consecutive subframes, denoted as $n_{abs,1}$, satisfies $(n_{abs,1} + i_{\Delta}) \bmod N_{NB}^{ch,DL} = 0$.

For PDSCH transmission associated with SI-RNTI or P-RNTI to BL/CE UEs, frequency hopping of the PDSCH is enabled when higher layer parameter *si-HoppingConfigCommon* is set.

For PDSCH transmission associated with PUR C-RNTI to BL/CE UEs using UE-specific MPDCCH search space, frequency hopping of the PDSCH is enabled when higher layer parameter *pur-PDSCH-FreqHopping* is set.

For PDSCH transmission associated with RA-RNTI or temporary C-RNTI to BL/CE UEs, frequency hopping of the PDSCH is enabled when higher layer parameter *rar-HoppingConfig* is set. Further

- if PRACH CE level 0 or 1 is used for the last PRACH attempt, $N_{NB}^{ch,DL}$ is set to the higher layer parameter *interval-DlHoppingConfigCommonModeA*;
- if PRACH CE level 2 or 3 is used for the last PRACH attempt, $N_{NB}^{ch,DL}$ is set to the higher layer parameter *interval-DlHoppingConfigCommonModeB*.

For PDSCH transmission associated with SC-RNTI to BL/CE UEs, frequency hopping of the PDSCH is enabled when higher layer parameter *mpdcch-pdsch-HoppingConfig-SC-MCCH* is set. Further

- if *mpdcch-pdsch-HoppingConfig-SC-MCCH* is set to CEModeA, $N_{NB}^{ch,DL}$ is set to the higher layer parameter *interval-DLHoppingConfigCommonModeA*;
- if *mpdcch-pdsch-HoppingConfig-SC-MCCH* is set to CEModeB, $N_{NB}^{ch,DL}$ is set to the higher layer parameter *interval-DLHoppingConfigCommonModeB*.

For PDSCH transmission associated with G-RNTI to BL/CE UEs,

- if the higher layer parameter *mpdcch-pdsch-CEmodeConfig-SC-MTCH* is set to CEModeA,
 - if the higher layer parameter *mpdcch-pdsch-HoppingConfig-SC-MTCH* is set and the frequency hopping flag in DCI format 6-1A indicates frequency hopping, then frequency hopping of the PDSCH is enabled and $N_{NB}^{ch,DL}$ is set to the higher layer parameter *interval-DLHoppingConfigCommonModeA*, otherwise frequency hopping is not enabled;
- if the higher layer parameter *mpdcch-pdsch-CEmodeConfig-SC-MTCH* is set to CEModeB,
 - if the higher layer parameter *mpdcch-pdsch-HoppingConfig-SC-MTCH* is set, then frequency hopping of the PDSCH is enabled and $N_{NB}^{ch,DL}$ is set to the higher layer parameter *interval-DLHoppingConfigCommonModeB*, otherwise frequency hopping is not enabled.

6.4.2 Slot/subslot-based physical downlink shared channel

For slot or subslot-based PDSCH, in this specification referred to as slot-PDSCH and subslot-PDSCH respectively, the following additions and exceptions hold in addition to those in clause 6.4:

- PDSCH is not mapped to resource elements of SCCEs used by the associated SPDCCH, or resource elements used for UE-specific reference signals associated with SPDCCH
- In case of slot-PDSCH:
 - the mapping to resource elements (k, l) on antenna port p not reserved for other purposes shall be in increasing order of first the index k over the assigned physical resource blocks and then the index l , for the slot of the assigned physical resources in the subframe, and
 - in case of UE-specific reference signals, the PDSCH is not mapped to any physical resource blocks carrying PBCH.
- In case of subslot-PDSCH:
 - the mapping to resource elements (k, l) on antenna port p not reserved for other purposes shall be in increasing order of first the index k over the assigned physical resource blocks and then the index l , starting from l_0 given in Table 6.4.2-1. The starting value l_0 and the value range of l depends on the number of symbols used for PDCCH and the subslot number in the subframe, according to Table 6.4.2-1, and
 - in case of UE-specific reference signals,
 - the PDSCH is not mapped to any physical resource blocks in frequency domain carrying PBCH or synchronization signals for the OFDM symbols of the given subslot.
 - and in case the DCI associated with the subslot-PDSCH indicates the absence of the UE-specific reference signals (see *DMRS position indicator* field in 3GPP TS 36.212 [3]), the PDSCH is not mapped to any physical resource blocks in frequency domain that carried PBCH or synchronization signals for the OFDM symbols of the previous subslot.

Table 6.4.2-1: Starting value of index l , i.e. l_0 , for subslot PDSCH

Number of symbols used for PDCCH	Downlink subslot index					
	#0	#1	#2	#3	#4	#5
1	1	3	5	0	2	4
2	-	2	5	0	2	4

3	-	3	5	0	2	4
---	---	---	---	---	---	---

- For PDSCH associated with UE-specific reference signals,
 - the PDSCH shall only be mapped to physical resource blocks in frequency domain assigned for PDSCH transmission where the assignment maps to both physical resource blocks of a PRG.
 - the subslot-PDSCH shall not be mapped to the physical resource blocks of a PRG in case the resource elements of the associated SPDCCH are mapped to those physical resource blocks.
- In addition, the following additions and exceptions related to L1 signaling and/or higher layer configuration controlling rate-matching around SPDCCH resources hold:
 - PDSCH is not mapped to resource elements belonging to a SPDCCH resource set configured with higher layer parameter *rateMatchingMode* indicating 'm2' if either this SPDCCH resource set is not configured with higher layer parameter *spdcch-L1-ReuseIndication* or it is configured with higher layer parameter *spdcch-L1-ReuseIndication* 'n1' or 'n2' indicating '0' for the SPDCCH resource set.
 - PDSCH is not mapped to resource elements belonging to a SPDCCH resource set configured with higher layer parameter *rateMatchingMode* indicating 'm3' if the SPDCCH associated with PDSCH is found in this SPDCCH resource set and if either this SPDCCH resource set is not configured with higher layer parameter *spdcch-L1-ReuseIndication* or it is configured with higher layer parameter *spdcch-L1-ReuseIndication* 'n1' or 'n2' indicating '0' for the SPDCCH resource set. If the SPDCCH associated with PDSCH is found on a candidate belonging to two SPDCCH resource sets, the SPDCCH is assumed to be found in both SPDCCH resource sets.
 - PDSCH is not mapped to resource elements belonging to a SPDCCH resource set configured with higher layer parameter *rateMatchingMode* indicating 'm4' if the SPDCCH associated with PDSCH is not found in this SPDCCH resource set and if either this SPDCCH resource set is not configured with higher layer parameter *spdcch-L1-ReuseIndication* or it is configured with higher layer parameter *spdcch-L1-ReuseIndication* 'n1' or 'n2' indicating '0' for the SPDCCH resource set.
 - PDSCH is not mapped to resource elements belonging to a SPDCCH resource set configured with higher layer parameter *spdcch-L1-ReuseIndication* 'n0' if the bit of the Used/Unused SPDCCH resource indication field corresponding to this SPDCCH resource set in the DCI format 7 associated with PDSCH is set to 1.
 - PDSCH is not mapped to resource elements belonging to SCCE#0 to SCCE# $\left(\left\lfloor \frac{N_{\text{SCCE}_m}}{2} \right\rfloor - 1\right)$ of a SPDCCH resource set configured with higher layer parameter *spdcch-L1-ReuseIndication* 'n1' or 'n2' indicating '2' for the SPDCCH resource set if the most significant bit of the Used/Unused SPDCCH resource indication field in the DCI format 7 associated with PDSCH is set to 1.
 - PDSCH is not mapped to resource elements belonging to SCCE# $\left\lfloor \frac{N_{\text{SCCE}_m}}{2} \right\rfloor$ to SCCE# $(N_{\text{SCCE}_m} - 1)$ of a SPDCCH resource set configured with higher layer parameter *spdcch-L1-ReuseIndication* 'n1' or 'n2' indicating '2' for the SPDCCH resource set if the least significant bit of the Used/Unused SPDCCH resource indication field in the DCI format 7 associated with PDSCH is set to 1.
 - It should be noted that not mapping PDSCH to resource elements belonging to a SPDCCH resource set holds irrespective of other indications (*spdcch-L1-ReuseIndication* or *rateMatchingMode*) associated with other SPDCCH resource sets (if configured).
 - For a UE with the higher-layer parameter *blindSlotSubslotPDSCH-Repetitions* set to TRUE and PDSCH associated with a downlink assignment sent on PDCCH/SPDCCH with DCI format 7 indicating k transmissions, the rate-matching around SPDCCH resources if applicable for PDSCH in the $k - 1$ valid slots/subslots following the slot/subslot containing the downlink assignment follows
 - the rate-matching around SPDCCH resources of the PDSCH in the slot/subslot containing the downlink assignment, if the DCI format 7 indicating k transmissions is received on SPDCCH.
 - the rate-matching around SPDCCH resources of the PDSCH in the SPDCCH resource set according to

rateMatchingMode indicating ‘m2’, if configured by higher layers, if the DCI format 7 indicating k transmissions is received on PDCCH. For other configurations of *rateMatchingMode*, no rate-matching around SPDCCCH resources for PDSCH in the $k - 1$ valid slots/subslots following the PDCCH with DCI format 7 indicating k PDSCH transmissions is applied..

6.5 Physical multicast channel

The physical multicast channel shall be processed and mapped to resource elements as described in clause 6.3 with the following exceptions:

- No transmit diversity scheme is specified.
- Layer mapping and precoding shall be done assuming a single antenna port and the transmission shall use antenna port 4.
- The PMCH can only be transmitted in the MBSFN region. For PMCH with $\Delta f = 15$ kHz, the index l in the first slot in the MBSFN subframe fulfils $l \geq l_{\text{PMCHStart}}$ where $l_{\text{PMCHStart}}$ is equal to the value given by the higher layer parameter *non-MBSFNregionLength* [9].
- The PMCH shall use extended cyclic prefix.
- The PMCH is not mapped to resource elements used for transmission of MBSFN reference signals.
- In clause 6.3.1, for $\Delta f = 1.25$ kHz and $\Delta f \approx 0.37$ kHz, the scrambling generator shall be initialised at the start of each slot.
- For $\Delta f = 1/(82944T_s) \approx 0.37$ kHz the following exception applies to clause 6.3.5:
 - The text “which meet all of the following criteria in the current subframe” shall be replaced by “which meet all of the following criteria in the current slot”
 - The mapping to resource elements (k, l) on antenna port p not reserved for other purposes shall be in increasing order of first the index k over the assigned physical resource blocks and then the index l .

6.6 Physical broadcast channel

The PBCH is not transmitted for frame structure type 3.

6.6.1 Scrambling

The block of bits $b(0), \dots, b(M_{\text{bit}} - 1)$, where M_{bit} , the number of bits transmitted on the physical broadcast channel, equals 1920 for normal cyclic prefix and 1728 for extended cyclic prefix, shall be scrambled with a cell-specific sequence prior to modulation, resulting in a block of scrambled bits $\tilde{b}(0), \dots, \tilde{b}(M_{\text{bit}} - 1)$ according to

$$\tilde{b}(i) = (b(i) + c(i)) \bmod 2$$

where the scrambling sequence $c(i)$ is given by clause 7.2. The scrambling sequence shall be initialised with

$c_{\text{init}} = N_{\text{ID}}^{\text{cell}}$ in each radio frame fulfilling $n_f \bmod 4 = 0$. For an MBMS-dedicated cell, the scrambling sequence shall be initialised with $c_{\text{init}} = 2^9 + N_{\text{ID}}^{\text{cell}}$ in each radio frame fulfilling $n_f \bmod 16 = 0$.

6.6.2 Modulation

The block of scrambled bits $\tilde{b}(0), \dots, \tilde{b}(M_{\text{bit}} - 1)$ shall be modulated as described in clause 7.1, resulting in a block of complex-valued modulation symbols $d(0), \dots, d(M_{\text{symp}} - 1)$. Table 6.6.2-1 specifies the modulation mappings applicable for the physical broadcast channel.

Table 6.6.2-1: PBCH modulation schemes.

Physical channel	Modulation schemes
PBCH	QPSK

6.6.3 Layer mapping and precoding

The block of modulation symbols $d(0), \dots, d(M_{\text{symb}} - 1)$ shall be mapped to layers according to one of clauses 6.3.3.1 or 6.3.3.3 with $M_{\text{symb}}^{(0)} = M_{\text{symb}}$ and precoded according to one of clauses 6.3.4.1 or 6.3.4.3, resulting in a block of vectors $y(i) = [y^{(0)}(i) \ \dots \ y^{(P-1)}(i)]^T$, $i = 0, \dots, M_{\text{symb}} - 1$, where $y^{(p)}(i)$ represents the signal for antenna port p and where $p = 0, \dots, P-1$ and the number of antenna ports for cell-specific reference signals $P \in \{1, 2, 4\}$.

6.6.4 Mapping to resource elements

The block of complex-valued symbols $y^{(p)}(0), \dots, y^{(p)}(M_{\text{symb}} - 1)$ for each antenna port shall

- for an MBMS-dedicated cell, be transmitted during 4 consecutive radio frames fulfilling $n_f \bmod 4 = 0$, starting in each radio frame fulfilling $n_f \bmod 16 = 0$, and
- otherwise, be transmitted during 4 consecutive radio frames, starting in each radio frame fulfilling $n_f \bmod 4 = 0$

The block of complex-valued symbols shall be mapped in sequence starting with $y(0)$ to resource elements (k, l) constituting the core set of PBCH resource elements. The mapping to resource elements (k, l) not reserved for transmission of reference signals shall be in increasing order of first the index k , then the index l in slot 1 in subframe 0 and finally the radio frame number. The resource-element indices are given by

$$k = \frac{N_{\text{RB}}^{\text{DL}} N_{\text{sc}}^{\text{RB}}}{2} - 36 + k', \quad k' = 0, 1, \dots, 71$$

$$l = 0, 1, \dots, 3$$

where resource elements reserved for reference signals shall be excluded. The mapping operation shall assume cell-specific reference signals for antenna ports 0-3 being present irrespective of the actual configuration. The UE shall assume that the resource elements assumed to be reserved for reference signals in the mapping operation above but not used for transmission of reference signal are not available for PDSCH or MPDCCH transmission. The UE shall not make any other assumptions about these resource elements.

For an MBMS-dedicated cell configured with repetition, the physical broadcast channel shall be repeated as described in clause 6.6.4.1.

If a cell is configured with repetition of the physical broadcast channel

- symbols mapped to core resource element (k, l) in slot 1 in subframe 0 within a radio frame n_f according to the mapping operation above, and
- cell-specific reference signals in OFDM symbols l in slot 1 in subframe 0 within a radio frame n_f with l according to the mapping operation above

shall additionally be mapped to resource elements (k, l') in slot number n'_s within radio frame $n_f - i$ unless resource element (k, l') is used by CSI reference signals.

For frame structure type 1, l' , n'_s , and i are given by Table 6.6.4-1.

For frame structure type 2,

- if $N_{\text{RB}}^{\text{DL}} > 15$, l' and n'_s are given by Table 6.6.4-2 and $i = 0$;

- if $7 \leq N_{RB}^{DL} \leq 15$, l' and n'_s are given by Table 6.6.4-2 and $i=0$, except that repetitions with $n'_s = 10$ and $n'_s = 11$ are not applied.

For both frame structure type 1 and frame structure type 2, repetition of the physical broadcast channel is not applicable if $N_{RB}^{DL} = 6$.

Resource elements already reserved or used for transmission of cell-specific reference signals in absence of repetition shall not be used for additional mapping of cell-specific reference signals.

Table 6.6.4-1: Frame offset, slot and symbol number triplets for repetition of PBCH for frame structure type 1.

l	Frame offset, slot and symbol number triplets (i, n'_s, l')	
	Normal cyclic prefix	Extended cyclic prefix
0	(1,18,3), (1,19,0), (1,19,4), (0,0,4)	(1,18,3), (1,19,0), (1,19,5)
1	(1,18,4), (1,19,1), (1,19,5), (0,1,4)	(1,18,4), (1,19,1), (0,0,3)
2	(1,18,5), (1,19,2), (1,19,6), (0,1,5)	(1,18,5), (1,19,2), (0,1,4)
3	(1,18,6), (1,19,3), (0,0,3), (0,1,6)	(1,19,3), (1,19,4), (0,1,5)

Table 6.6.4-2: Slot and symbol number pairs for repetition of PBCH for frame structure type 2.

l	Slot and symbol number pairs (n'_s, l')	
	Normal cyclic prefix	Extended cyclic prefix
0	(0,3), (1,4), (10,3), (11,0), (11,4)	(0,3), (10,3), (11,0)
1	(0,4), (1,5), (10,4), (11,1), (11,5)	(0,4), (10,4), (11,1)
2	(0,5), (10,5), (11,2)	(0,5), (10,5), (11,2)
3	(0,6), (10,6), (11,3)	(1,4), (11,3), (11,4)

6.6.4.1 PBCH repetition in the cell acquisition subframe

For a MBMS-dedicated cell with $N_{RB}^{DL} > 6$,

- symbols mapped to core resource element (k, l) in slot 1 in subframe 0 within a radio frame n_f according to the mapping operation in clause 6.6.4, and
- cell-specific reference signals in OFDM symbols l in slot 1 in subframe 0 within a radio frame n_f with l according to the mapping operation in clause 6.6.4

shall additionally be multiplied by $\theta_{k,l'}$ and mapped to resource elements (k, l') in slot number n'_s within radio frame n_f where l' and n'_s are given by Table 6.6.4.1-1 in frames fulfilling

- $n_f \bmod 4 = 0$ for $25 \leq N_{RB}^{DL}$;
- $n_f \bmod 8 = 4$ for $6 < N_{RB}^{DL} < 25$

Resource elements already reserved or used for transmission of cell-specific reference signals in absence of repetition shall not be used for additional mapping of cell-specific reference signals.

The quantity $\theta_{k,l'}$ is given by

$$\theta_{k,l'} = e^{j\pi c(2k)/2} e^{j\pi c(2k+1)}$$

where the pseudo-random sequence $c(i)$ is given by clause 7.2 and initialized for each OFDM symbol l' with

$$c_{\text{init}} = 2^{13} \left((N_{ID}^{\text{cell}} + 1)(N_{\text{symb}}^{\text{DL}} n'_s + l' + 1) \right) + 2^4 N_{ID}^{\text{cell}} + (N_{\text{symb}}^{\text{DL}} n'_s + l')$$

Table 6.6.4.1-1: Slot and symbol number pair for repetition of PBCH.

l	Slot and symbol number pair (n'_s, l')	
	Normal cyclic prefix	Extended cyclic prefix
0	(0, 4)	-
1	(1, 4)	(0, 3)
2	(1, 5)	(1, 4)
3	(0, 3), (1, 6)	(1, 5)

6.7 Physical control format indicator channel

The physical control format indicator channel carries information about the number of OFDM symbols used for transmission of PDCCHs in a subframe. The set of OFDM symbols possible to use for PDCCH in a subframe is given by Table 6.7-1.

Table 6.7-1: Number of OFDM symbols used for PDCCH

Subframe	Number of OFDM symbols for PDCCH when $N_{RB}^{DL} > 10$	Number of OFDM symbols for PDCCH when $N_{RB}^{DL} \leq 10$
Subframe 1 and 6 for frame structure type 2 or a subframe for frame structure type 3 with the same duration as the DwPTS duration of a special subframe configuration	1, 2	2
MBSFN subframes with $\Delta f = 15$ kHz and configured with 1 or 2 cell-specific antenna ports	1, 2	2
MBSFN subframes with $\Delta f = 15$ kHz and configured with 4 cell-specific antenna ports	2	2
MBSFN subframes with $\Delta f \in \{7.5, 2.5, 1.25\}$ kHz or MBSFN slots with $\Delta f \approx 0.37$ kHz	0	0
Non-MBSFN subframes (except subframe 6 for frame structure type 2) configured with positioning reference signals	1, 2, 3	2, 3
All other cases	1, 2, 3	2, 3, 4

The UE may assume the PCFICH is transmitted when the number of OFDM symbols for PDCCH is greater than zero unless stated otherwise in [4, clause 12].

6.7.1 Scrambling

The block of bits $b(0), \dots, b(31)$ transmitted in one subframe shall be scrambled with a cell-specific sequence prior to modulation, resulting in a block of scrambled bits $\tilde{b}(0), \dots, \tilde{b}(31)$ according to

$$\tilde{b}(i) = (b(i) + c(i)) \bmod 2$$

where the scrambling sequence $c(i)$ is given by clause 7.2. The scrambling sequence generator shall be initialised with $c_{\text{init}} = (\lfloor n_s/2 \rfloor + 1) \cdot (2N_{ID}^{\text{cell}} + 1) \cdot 2^9 + N_{ID}^{\text{cell}}$ at the start of each subframe.

6.7.2 Modulation

The block of scrambled bits $\tilde{b}(0), \dots, \tilde{b}(31)$ shall be modulated as described in clause 7.1, resulting in a block of complex-valued modulation symbols $d(0), \dots, d(15)$. Table 6.7.2-1 specifies the modulation mappings applicable for the physical control format indicator channel.

Table 6.7.2-1: PCFICH modulation schemes

Physical channel	Modulation schemes
PCFICH	QPSK

6.7.3 Layer mapping and precoding

The block of modulation symbols $d(0), \dots, d(15)$ shall be mapped to layers according to one of clauses 6.3.3.1 or 6.3.3.3 with $M_{\text{symb}}^{(0)} = 16$ and precoded according to one of clauses 6.3.4.1 or 6.3.4.3, resulting in a block of vectors

$y(i) = [y^{(0)}(i) \ \dots \ y^{(P-1)}(i)]^T$, $i = 0, \dots, 15$, where $y^{(p)}(i)$ represents the signal for antenna port p and where $p = 0, \dots, P-1$ and the number of antenna ports for cell-specific reference signals $P \in \{1, 2, 4\}$. The PCFICH shall be transmitted on the same set of antenna ports as the PBCH.

6.7.4 Mapping to resource elements

The mapping to resource elements is defined in terms of quadruplets of complex-valued symbols. Let

$z^{(p)}(i) = \langle y^{(p)}(4i), y^{(p)}(4i+1), y^{(p)}(4i+2), y^{(p)}(4i+3) \rangle$ denote symbol quadruplet i for antenna port p . For each of the antenna ports, symbol quadruplets shall be mapped in increasing order of i to the four resource-element groups in the first OFDM symbol in a downlink subframe or DwPTS with the representative resource-element as defined in clause 6.2.4 given by

$$\begin{aligned} z^{(p)}(0) & \text{ is mapped to the resource - element group represented by } k = \bar{k} \\ z^{(p)}(1) & \text{ is mapped to the resource - element group represented by } k = \bar{k} + \left\lfloor N_{\text{RB}}^{\text{DL}} / 2 \right\rfloor \cdot N_{\text{sc}}^{\text{RB}} / 2 \\ z^{(p)}(2) & \text{ is mapped to the resource - element group represented by } k = \bar{k} + \left\lfloor 2N_{\text{RB}}^{\text{DL}} / 2 \right\rfloor \cdot N_{\text{sc}}^{\text{RB}} / 2 \\ z^{(p)}(3) & \text{ is mapped to the resource - element group represented by } k = \bar{k} + \left\lfloor 3N_{\text{RB}}^{\text{DL}} / 2 \right\rfloor \cdot N_{\text{sc}}^{\text{RB}} / 2 \end{aligned}$$

where the additions are modulo $N_{\text{RB}}^{\text{DL}} N_{\text{sc}}^{\text{RB}}$,

$$\bar{k} = (N_{\text{sc}}^{\text{RB}} / 2) \cdot (N_{\text{ID}}^{\text{cell}} \bmod 2N_{\text{RB}}^{\text{DL}})$$

and $N_{\text{ID}}^{\text{cell}}$ is the physical-layer cell identity as given by clause 6.11.

6.8 Physical downlink control channel

6.8.1 PDCCH formats

The physical downlink control channel carries scheduling assignments and other control information. A physical control channel is transmitted on an aggregation of one or several consecutive control channel elements (CCEs), where a control channel element corresponds to 9 resource element groups. The number of resource-element groups not assigned to PCFICH or PHICH is N_{REG} . The CCEs available in the system are numbered from 0 to $N_{\text{CCE}} - 1$, where $N_{\text{CCE}} = \lfloor N_{\text{REG}} / 9 \rfloor$. The PDCCH supports multiple formats as listed in Table 6.8.1-1 where PDCCH format 4 is supported only for non-MBSFN subframes in an MBMS-dedicated cell. A PDCCH consisting of n consecutive CCEs may only start on a CCE fulfilling $i \bmod n = 0$, where i is the CCE number.

Multiple PDCCHs can be transmitted in a subframe.

Table 6.8.1-1: Supported PDCCH formats

PDCCH format	Number of CCEs	Number of resource-element groups	Number of PDCCH bits
0	1	9	72
1	2	18	144
2	4	36	288
3	8	72	576
4	16	144	1152

6.8.2 PDCCH multiplexing and scrambling

The block of bits $b^{(i)}(0), \dots, b^{(i)}(M_{\text{bit}}^{(i)} - 1)$ on each of the control channels to be transmitted in a subframe, where $M_{\text{bit}}^{(i)}$ is the number of bits in one subframe to be transmitted on physical downlink control channel number i , shall be multiplexed, resulting in a block of bits

$b^{(0)}(0), \dots, b^{(0)}(M_{\text{bit}}^{(0)} - 1), b^{(1)}(0), \dots, b^{(1)}(M_{\text{bit}}^{(1)} - 1), \dots, b^{(n_{\text{PDCCH}})}(0), \dots, b^{(n_{\text{PDCCH}})}(M_{\text{bit}}^{(n_{\text{PDCCH}})} - 1)$, where n_{PDCCH} is the number of PDCCHs transmitted in the subframe.

The block of bits $b^{(0)}(0), \dots, b^{(0)}(M_{\text{bit}}^{(0)} - 1), b^{(1)}(0), \dots, b^{(1)}(M_{\text{bit}}^{(1)} - 1), \dots, b^{(n_{\text{PDCCH}})}(0), \dots, b^{(n_{\text{PDCCH}})}(M_{\text{bit}}^{(n_{\text{PDCCH}})} - 1)$ shall be scrambled with a cell-specific sequence prior to modulation, resulting in a block of scrambled bits $\tilde{b}(0), \dots, \tilde{b}(M_{\text{tot}} - 1)$ according to

$$\tilde{b}(i) = (b(i) + c(i)) \bmod 2$$

where the scrambling sequence $c(i)$ is given by clause 7.2. The scrambling sequence generator shall be initialised with $c_{\text{init}} = \lfloor n_s / 2 \rfloor 2^9 + N_{\text{ID}}^{\text{cell}}$ at the start of each subframe.

CCE number n corresponds to bits $b(72n), b(72n+1), \dots, b(72n+71)$. If necessary, <NIL> elements shall be inserted in the block of bits prior to scrambling to ensure that the PDCCHs starts at the CCE positions as described in 3GPP TS 36.213 [4] and to ensure that the length $M_{\text{tot}} = 8N_{\text{REG}} \geq \sum_{i=0}^{n_{\text{PDCCH}}-1} M_{\text{bit}}^{(i)}$ of the scrambled block of bits matches the amount of resource-element groups not assigned to PCFICH or PHICH.

6.8.3 Modulation

The block of scrambled bits $\tilde{b}(0), \dots, \tilde{b}(M_{\text{tot}} - 1)$ shall be modulated as described in clause 7.1, resulting in a block of complex-valued modulation symbols $d(0), \dots, d(M_{\text{symb}} - 1)$. Table 6.8.3-1 specifies the modulation mappings applicable for the physical downlink control channel.

Table 6.8.3-1: PDCCH modulation schemes

Physical channel	Modulation schemes
PDCCH	QPSK

6.8.4 Layer mapping and precoding

The block of modulation symbols $d(0), \dots, d(M_{\text{symb}} - 1)$ shall be mapped to layers according to one of clauses 6.3.3.1 or 6.3.3.3 with $M_{\text{symb}}^{(0)} = M_{\text{symb}}$ and precoded according to one of clauses 6.3.4.1 or 6.3.4.3, resulting in a block of vectors

$y(i) = [y^{(0)}(i) \ \dots \ y^{(P-1)}(i)]^T$, $i = 0, \dots, M_{\text{symb}} - 1$ to be mapped onto resources on the antenna ports used for transmission, where $y^{(p)}(i)$ represents the signal for antenna port p . The PDCCH shall be transmitted on the same set of antenna ports as the PBCH.

6.8.5 Mapping to resource elements

The mapping to resource elements is defined by operations on quadruplets of complex-valued symbols. Let $z^{(p)}(i) = \langle y^{(p)}(4i), y^{(p)}(4i+1), y^{(p)}(4i+2), y^{(p)}(4i+3) \rangle$ denote symbol quadruplet i for antenna port p .

The block of quadruplets $z^{(p)}(0), \dots, z^{(p)}(M_{\text{quad}} - 1)$, where $M_{\text{quad}} = M_{\text{symb}} / 4$, shall be permuted resulting in $w^{(p)}(0), \dots, w^{(p)}(M_{\text{quad}} - 1)$. The permutation shall be according to the sub-block interleaver in clause 5.1.4.2.1 of 3GPP TS 36.212 [3] with the following exceptions:

- the input and output to the interleaver is defined by symbol quadruplets instead of bits

- interleaving is performed on symbol quadruplets instead of bits by substituting the terms "bit", "bits" and "bit sequence" in clause 5.1.4.2.1 of 3GPP TS 36.212 [3] by "symbol quadruplet", "symbol quadruplets" and "symbol-quadruplet sequence", respectively

<NULL> elements at the output of the interleaver in 3GPP TS 36.212 [3] shall be removed when forming $w^{(p)}(0), \dots, w^{(p)}(M_{\text{quad}}-1)$. Note that the removal of <NULL> elements does not affect any <NIL> elements inserted in clause 6.8.2.

The block of quadruplets $w^{(p)}(0), \dots, w^{(p)}(M_{\text{quad}}-1)$ shall be cyclically shifted, resulting in $\bar{w}^{(p)}(0), \dots, \bar{w}^{(p)}(M_{\text{quad}}-1)$ where $\bar{w}^{(p)}(i) = w^{(p)}\left((i + N_{\text{ID}}^{\text{cell}}) \bmod M_{\text{quad}}\right)$.

Mapping of the block of quadruplets $\bar{w}^{(p)}(0), \dots, \bar{w}^{(p)}(M_{\text{quad}}-1)$ is defined in terms of resource-element groups, specified in clause 6.2.4, according to steps 1–10 below:

- 1) Initialize $m' = 0$ (resource-element group number)
- 2) Initialize $k' = 0$
- 3) Initialize $l' = 0$
- 4) If the resource element (k', l') represents a resource-element group and the resource-element group is not assigned to PCFICH or PHICH then perform step 5 and 6, else go to step 7
 - 5) Map symbol-quadruplet $\bar{w}^{(p)}(m')$ to the resource-element group represented by (k', l') for each antenna port p
 - 6) Increase m' by 1
- 7) Increase l' by 1
- 8) Repeat from step 4 if $l' < L$, where L corresponds to the number of OFDM symbols used for PDCCH transmission. The quantity L is obtained from
 - the sequence transmitted on the PCFICH, or
 - the higher-layer parameter *cfi-SubframeMBSFN-r15* for DCI formats other than DCI format 7 in a MBSFN subframe, or
 - the higher-layer parameter *cfi-SlotSubslotMBSFN-r15* for DCI format 7 in a MBSFN subframe, or
 - the higher-layer parameter *cfi-SubframeNonMBSFN-r15* for DCI formats other than DCI format 7 in a non-MBSFN subframe, or
 - the higher-layer parameter *cfi-SlotSubslotNonMBSFN-r15* for DCI format 7 in a non-MBSFN subframe, or
 - the higher-layer parameter *cfi-PatternSubframe-r15* for DCI formats other than DCI format 7 in one subframe for frame structure 2, or
 - the higher-layer parameter *cfi-PatternSlotSubslot-r15* for DCI formats 7 in one subframe for frame structure 2.
- 9) Increase k' by 1
- 10) Repeat from step 3 if $k' < N_{\text{RB}}^{\text{DL}} \cdot N_{\text{sc}}^{\text{RB}}$

PDCCHs shall not be transmitted in MBSFN subframes with zero-size non-MBSFN region.

6.8A Enhanced physical downlink control channel

For frame structure type 3, for a subframe with the same duration as the DwPTS duration of a special subframe configuration, the enhanced physical downlink control channel is defined the same as that for the corresponding special subframe configuration.

6.8A.1 EPDCCH formats

The enhanced physical downlink control channel (EPDCCH) carries scheduling assignments. An enhanced physical downlink control channel is transmitted using an aggregation of one or several consecutive enhanced control channel elements (ECCEs) where each ECCE consists of multiple enhanced resource element groups (REGs), defined in clause 6.2.4A. The number of ECCEs used for one EPDCCH depends on the EPDCCH format as given by Table 6.8A.1-2 and the number of REGs per ECCE is given by Table 6.8A.1-1. Both localized and distributed transmission is supported.

An EPDCCH can use either localized or distributed transmission, differing in the mapping of ECCEs to REGs and PRB pairs.

A UE shall monitor multiple EPDCCHs as defined in 3GPP TS 36.213 [4]. One or two sets of physical resource-block pairs which a UE shall monitor for EPDCCH transmissions can be configured. All EPDCCH candidates in EPDCCH set X_m use either only localized or only distributed transmission as configured by higher layers. Within EPDCCH set

X_m in subframe i , the ECCEs available for transmission of EPDCCHs are numbered from 0 to $N_{ECCE,m,i} - 1$ and ECCE number n corresponds to

- REGs numbered $(n \bmod N_{ECCE}^{RB}) + jN_{ECCE}^{RB}$ in PRB index $\lfloor n / N_{ECCE}^{RB} \rfloor$ for localized mapping, and
- REGs numbered $\lfloor n / N_{RB}^{X_m} \rfloor + jN_{ECCE}^{RB}$ in PRB indices $(n + j \max(1, N_{RB}^{X_m} / N_{REG}^{ECCE})) \bmod N_{RB}^{X_m}$ for distributed mapping,

where $j = 0, 1, \dots, N_{REG}^{ECCE} - 1$, N_{REG}^{ECCE} is the number of REGs per ECCE, and $N_{ECCE}^{RB} = 16 / N_{REG}^{ECCE}$ is the number of ECCEs per resource-block pair. The physical resource-block pairs constituting EPDCCH set X_m are in this paragraph assumed to be numbered in ascending order from 0 to $N_{RB}^{X_m} - 1$.

Table 6.8A.1-1: Number of REGs per ECCE, N_{REG}^{ECCE}

Normal cyclic prefix			Extended cyclic prefix	
Normal subframe	Special subframe, configuration 3, 4, 8	Special subframe, configuration 1, 2, 6, 7, 9, 10	Normal subframe	Special subframe, configuration 1, 2, 3, 5, 6
	4		8	

Table 6.8A.1-2: Supported EPDCCH formats

EPDCCH format	Number of ECCEs for one EPDCCH, N_{ECCE}^{EPDCCH}			
	Case A		Case B	
	Localized transmission	Distributed transmission	Localized transmission	Distributed transmission
0	2	2	1	1
1	4	4	2	2
2	8	8	4	4
3	16	16	8	8
4	-	32	-	16

Case A in Table 6.8A.1-2 is used when the conditions corresponding to case 1 in clause 9.1.4 of 3GPP TS 36.213 [4] are satisfied, otherwise case B is used. The quantity n_{EPDCCH} for a particular UE and referenced in 3GPP TS 36.213 [4]

is defined as the number of downlink resource elements (k,l) available for EPDCCH transmission in a physical resource-block pair configured for possible EPDCCH transmission of EPDCCH set X_0 and fulfilling all of the following criteria:

- they are part of any one of the 16 EREGs in the physical resource-block pair, and
- they are assumed by the UE not to be used for cell-specific reference signals, where the positions of the cell-specific reference signals are given by clause 6.10.1.2 with the number of antenna ports for and the frequency shift of cell-specific reference signals derived as described in clause 6.10.1.2 unless other values for these parameters are provided by clause 9.1.4.3 in 3GPP TS 36.213 [4], and-
- they are assumed by the UE not to be used for transmission of CSI reference signals, where the positions of the CSI reference signals are given by clause 6.10.5.2 with the configuration for zero power CSI reference signals obtained as described in clause 6.10.5.2 unless other values are provided by clause 9.1.4.3 in 3GPP TS 36.213 [4], and with the configuration for non-zero power CSI reference signals obtained as described in clause 6.10.5.2, and
- for frame structure type 1 and 2, the index l in the first slot in a subframe fulfils $l \geq l_{\text{EPDCCHStart}}$ where $l_{\text{EPDCCHStart}}$ is given by clause 9.1.4.1 of 3GPP TS 36.213 [4], and
- for frame structure type 3,
 - if the higher layer parameter *subframeStartPosition* indicates 's07' and if the downlink transmission starts in the second slot of a subframe
 - the index l in the second slot in the subframe fulfils $l \geq l_{\text{EPDCCHStart}}$ where $l_{\text{EPDCCHStart}}$ is given by clause 9.1.4.1 of 3GPP TS 36.213 [4],
 - otherwise
 - the index l in the first slot in the subframe fulfils $l \geq l_{\text{EPDCCHStart}}$ where $l_{\text{EPDCCHStart}}$ is given by clause 9.1.4.1 of 3GPP TS 36.213 [4].

6.8A.2 Scrambling

The block of bits $b(0), \dots, b(M_{\text{bit}} - 1)$ to be transmitted on an EPDCCH in a subframe shall be scrambled, resulting in a block of scrambled bits $\tilde{b}(0), \dots, \tilde{b}(M_{\text{bit}} - 1)$ according to

$$\tilde{b}(i) = (b(i) + c(i)) \bmod 2$$

where the UE-specific scrambling sequence $c(i)$ is given by clause 7.2. The scrambling sequence generator shall be initialized with $c_{\text{init}} = \lfloor n_s/2 \rfloor \cdot 2^9 + n_{\text{ID},m}^{\text{EPDCCH}}$ where m is the EPDCCH set number.

6.8A.3 Modulation

The block of scrambled bits $\tilde{b}(0), \dots, \tilde{b}(M_{\text{bit}} - 1)$ shall be modulated as described in clause 7.1, resulting in a block of complex-valued modulation symbols $d(0), \dots, d(M_{\text{symp}} - 1)$. Table 6.8A.3-1 specifies the modulation mappings applicable for the enhanced physical downlink control channel.

Table 6.8A.3-1: EPDCCH modulation schemes

Physical channel	Modulation schemes
EPDCCH	QPSK

6.8A.4 Layer mapping and precoding

The block of complex-valued modulation symbols shall be mapped to a single layer and precoded according to 6.3.4.1 as for $y(i) = d(i)$, $i = 0, \dots, M_{\text{symb}} - 1$.

6.8A.5 Mapping to resource elements

The block of complex-valued symbols $y(0), \dots, y(M_{\text{symb}} - 1)$ shall be mapped in sequence starting with $y(0)$ to resource elements (k, l) on the associated antenna port which meet all of the following criteria:

- they are part of the EREGs assigned for the EPDCCH transmission, and
- they are assumed by the UE not to be used for cell-specific reference signals, where the positions of the cell-specific reference signals are given by clause 6.10.1.2 with the number of antenna ports for and the frequency shift of cell-specific reference signals derived as described in clause 6.10.1.2 unless other values for these parameters are provided by clause 9.1.4.3 in 3GPP TS 36.213 [4], and
- they are assumed by the UE not to be used for transmission of:
 - zero-power CSI reference signals, where the positions of the CSI reference signals are given by clause 6.10.5.2. The configuration for zero power CSI reference signals is
 - obtained as described in clause 6.10.5.2 unless other values are provided by clause 9.1.4.3 in 3GPP TS 36.213 [4], and
 - obtained by higher-layer configuration of up to five reserved CSI-RS resources as part of the discovery signal configuration following the procedure for zero-power CSI-RS in clause 6.10.5.2.
 - non-zero-power CSI reference signals for CSI reporting, except for non-zero power CSI reference signals configured by *csi-RS-ConfigNZP-APList*, with the configuration for non-zero power CSI reference signals for CSI reporting obtained as described in clause 6.10.5.2, and
- for frame structure type 1 and 2, the index l in the first slot in a subframe fulfils $l \geq l_{\text{EPDCCHstart}}$ where $l_{\text{EPDCCHstart}}$ is given by clause 9.1.4.1 of 3GPP TS 36.213 [4], and
- for frame structure type 3,
 - if the higher layer parameter *subframeStartPosition* indicates 's07' and if the downlink transmission starts in the second slot of a subframe
 - the index l in the second slot in the subframe fulfils $l \geq l_{\text{EPDCCHstart}}$ where $l_{\text{EPDCCHstart}}$ is given by clause 9.1.4.1 of 3GPP TS 36.213 [4],
 - otherwise
 - the index l in the first slot in the subframe fulfils $l \geq l_{\text{EPDCCHstart}}$ where $l_{\text{EPDCCHstart}}$ is given by clause 9.1.4.1 of 3GPP TS 36.213 [4].

The mapping to resource elements (k, l) on antenna port p meeting the criteria above shall be in increasing order of first the index k and then the index l , starting with the first slot and ending with the second slot in a subframe.

For localized transmission, the single antenna port p to use is given by Table 6.8A.5-1 with

$$n' = n_{\text{ECCElow}} \bmod N_{\text{ECCE}}^{\text{RB}} + n_{\text{RNTI}} \bmod \min(N_{\text{ECCE}}^{\text{EPDCCH}}, N_{\text{ECCE}}^{\text{RB}})$$

where n_{ECCElow} is the lowest ECCE index used by this EPDCCH transmission in the EPDCCH set, n_{RNTI} equals the C-RNTI, and $N_{\text{ECCE}}^{\text{EPDCCH}}$ is the number of ECCEs used for this EPDCCH.

Table 6.8A.5-1: Antenna port to use for localized EPDCCH transmission

	Normal cyclic prefix	Extended cyclic prefix
--	----------------------	------------------------

n'	Normal subframes, Special subframes, configurations 3, 4, 8	Special subframes, configurations 1, 2, 6, 7, 9, 10	Any subframe
0	107	107	107
1	108	109	108
2	109	-	-
3	110	-	-

For distributed transmission, each resource element in an EREG is associated with one out of two antenna ports in an alternating manner, starting with antenna port 107, where $p \in \{107,109\}$ for normal cyclic prefix and $p \in \{107,108\}$ for extended cyclic prefix.

6.8B MTC physical downlink control channel

6.8B.1 MPDCCH formats

The MPDCCH formats are defined as in Clause 6.8A.1 with the following exceptions:

- The term EPDCCH is replaced by MPDCCH.
- The MTC physical downlink control channel carries downlink control information and is transmitted across $N_{rep}^{MPDCCH} \geq 1$ consecutive BL/CE DL subframes. Within each of the N_{rep}^{MPDCCH} BL/CE DL subframes an MPDCCH is transmitted using an aggregation of one or several consecutive enhanced control channel elements (ECCEs) where each ECCE consists of multiple enhanced resource element groups (EREGs), defined in clause 6.2.4A.
- For frame structure type 2,
 - If repetition is not configured for the MPDCCH, the number of EREGs per ECCE is given by Table 6.8A.1-1. If repetition is configured for the MPDCCH, the number of EREGs per ECCE is given by Table 6.8B.1-1.
 - For those special subframes where the MPDCCH is not supported, these special subframes are considered BL/CE DL subframes for both MPDCCH and PDSCH transmission, only if they are indicated as BL/CE DL subframe by higher layer signalling.
- For an MPDCCH associated with 2 or 4 PRBs, if repetition is not configured for the MPDCCH, the supported MPDCCH formats are given by Table 6.8A.1-2. Otherwise, the supported MPDCCH formats are given by Table 6.8B.1-2. However, for MPDCCH format 5, the equation defining the relation between ECCE index and EREG index does not apply and the number of ECCEs refers to the MPDCCH mapping to the REs of the 2+4 PRB set as defined in Clause 6.8B.5.

Table 6.8B.1-1: Number of EREGs per ECCE, N_{EREG}^{ECCE} for frame structure type 2.

Normal cyclic prefix		Extended cyclic prefix	
Normal subframe	Special subframe, configuration 3, 4, 8	Normal subframe	Special subframe, configuration 1, 2, 3, 5, 6
4		8	

Table 6.8B.1-2: Supported MPDCCH formats

MPDCCH format	Number of ECCEs in a subframe for one MPDCCH, N_{ECCE}^{MPDCCH}			
	$N_{EREG}^{ECCE}=4$		$N_{EREG}^{ECCE}=8$	
	Localized transmission	Distributed transmission	Localized transmission	Distributed transmission
0	2	2	1	1
1	4	4	2	2
2	8	8	4	4

3	16	16	8	8
4	-	-	-	-
5	24	24	12	12

6.8B.2 Scrambling

Scrambling shall be performed according to Clause 6.8A.2 with EPDCCH replaced by MPDCCH except that the same scrambling sequence is applied per subframe to MPDCCH for a given block of N_{acc} subframes and m is the MPDCCH set number. For an MPDCCH associated with a 2+4 PRB set as defined in [4], $m=0$ is used to generate the scrambling sequence for mapping to REs in 6 PRBs as well as 2 PRBs and 4 PRBs.

The subframe number of the first subframe in each block of N_{acc} consecutive subframes, denoted as $n_{\text{abs},j}$, satisfies $(n_{\text{abs},1} + i_{\Delta}) \bmod N_{\text{acc}} = 0$. For the j^{th} block of N_{acc} subframes, the scrambling sequence generator shall be initialised with

$$c_{\text{init}} = \begin{cases} [(j_0 + j)N_{\text{acc}} \bmod 10] \cdot 2^9 + N_{\text{ID}}^{\text{cell}} & \text{for Type1 - Common, Type2 - common} \\ [(j_0 + j)N_{\text{acc}} \bmod 10] \cdot 2^9 + n_{\text{ID},m}^{\text{MPDCCH}} & \text{otherwise} \end{cases}$$

where

$$j = 0, 1, \dots, \left\lfloor \frac{i_0 + N_{\text{abs}}^{\text{MPDCCH}} + i_{\Delta} - 1}{N_{\text{acc}}} \right\rfloor - j_0$$

$$j_0 = \lfloor (i_0 + i_{\Delta}) / N_{\text{acc}} \rfloor$$

$$i_{\Delta} = \begin{cases} 0, & \text{for frame structure type 1 or } N_{\text{acc}} = 1 \\ N_{\text{acc}} - 2, & \text{for frame structure type 2 and } N_{\text{acc}} = 10 \end{cases}$$

and i_0 is the absolute subframe number of the first downlink subframe intended for the MPDCCH. The MPDCCH transmission spans $N_{\text{abs}}^{\text{MPDCCH}}$ consecutive subframes, including subframes that are not BL/CE DL subframes where the MPDCCH transmission is postponed.

For BL/CE UEs,

- if the MPDCCH transmission is associated with P-RNTI or SC-RNTI:
 - $N_{\text{acc}} = 4$ for frame structure type 1 and $N_{\text{acc}} = 10$ for frame structure type 2
- otherwise
 - $N_{\text{acc}} = 1$ for UEs assuming CEModeA (according to the definition in Clause 12 of [4]) or configured with CEModeA:
 - $N_{\text{acc}} = 4$ for frame structure type 1 and $N_{\text{acc}} = 10$ for frame structure type 2 for UEs assuming CEModeB (according to the definition in Clause 12 of [4]) or configured with CEModeB.

6.8B.3 Modulation

Modulation shall be performed according to 6.8A.3 with EPDCCH replaced by MPDCCH.

6.8B.4 Layer mapping and precoding

Layer mapping and precoding shall be done according to Clause 6.8A.4 with EPDCCH replaced by MPDCCH.

6.8B.5 Mapping to resource elements

Mapping to resource elements shall be done according to Clause 6.8A.5 with the following exceptions:

- The term EPDCCH shall be replaced by MPDCCH.
- The mapping shall be repeated across each of the $N_{\text{rep}}^{\text{MPDCCH}}$ BL/CE DL subframes.
- $N_{\text{ECCE}}^{\text{MPDCCH}}$ is the number of ECCEs used for this MPDCCH in the first of the $N_{\text{rep}}^{\text{MPDCCH}}$ subframes.
- For an MPDCCH associated with a 2+4 PRB set as defined in [4], the mapping to resource elements (k, l) on antenna port p shall be in increasing order of first the index k and then the index l over the 6 PRBs for MPDCCH format 5 and over the 2 or 4 PRBs for the other MPDCCH formats.
- For localized transmission and MPDCCH format 5, the single antenna port p to use is given by Table 6.8A.5-1 with

$$n' = n_{\text{RNTI}} \bmod N_{\text{ECCE}}^{\text{RB}}$$

where n_{RNTI} equals the C-RNTI.

- Resource elements occupied by CSI reference signals shall be counted in the MPDCCH mapping but not used for transmission of the MPDCCH.
- PRB pairs occupied by RSS shall be counted in the MPDCCH mapping but not used for transmission of the MPDCCH.
- Resource elements belonging to PRBs in which PRS is transmitted (including PRS muted subframes) shall be counted in the MPDCCH mapping but not used for transmission of the MPDCCH.
- A BL/CE UE not configured with higher layer parameter *ce-pdsch-maxBandwidth-config* and not configured with higher layer parameter *ce-PDSCH-FlexibleStartPRB-AllocConfig* may assume there is no MPDCCH transmission which uses overlapping sets of subframes as PDSCH transmissions to that UE, where the MPDCCH is located at a different narrowband than the PDSCH.
- A BL/CE UE configured with higher layer parameter *ce-pdsch-maxBandwidth-config* may assume that there is no MPDCCH transmission which uses overlapping sets of subframes as PDSCH transmissions to that UE, where the MPDCCH transmission and PDSCH transmission in any of the overlapping subframes span a PRB region larger than X contiguous PRBs where $X=25$ if *ce-pdsch-maxBandwidth-config* is set to 5 MHz and $X=100$ if *ce-pdsch-maxBandwidth-config* is set to 20 MHz.
- A BL/CE UE configured with higher layer parameter *ce-PDSCH-FlexibleStartPRB-AllocConfig* may assume there is no MPDCCH transmission in MPDCCH candidates not fully contained within the tuning narrowband defined for PDSCH in Clause 6.2.8.
- For BL/CE UEs in CEModeB, in MBSFN subframe(s), resource elements that correspond to the positions of cell-specific reference signals as in subframe #0 shall not be counted in the MPDCCH mapping and not used for transmission of the MPDCCH.
- Resource elements belonging to synchronization signals, the core part of PBCH, PBCH repetitions, or resource elements reserved for reference signals in the mapping operation of PBCH but not used for transmission of reference signals, shall be counted in the MPDCCH mapping but not used for transmission of the MPDCCH.
- If MPDCCH transmission in the LTE control region is configured by the higher layer parameter *transmissionInControlChRegion*,
 - For frame structure type 1 and frame structure type 2 except special subframe configuration 9 or 10,
 - Symbols used for transmission of MPDCCH or demodulation signals associated with MPDCCH and mapped to resource element (k, l) in the second slot, where $l \in \{0..l_{\text{MPDCCHstart}} - 1\}$, shall additionally be mapped to resource element (k, l) in the first slot.
 - For frame structure type 2 and special subframe configuration 9 or 10,
 - Symbols used for transmission of MPDCCH or demodulation signals associated with MPDCCH and mapped to resource element $(k, l + 4)$ in the first slot, where $l \in \{0..l_{\text{MPDCCHstart}} - 1\}$, shall additionally

be mapped to resource element (k, l) in the first slot, if resource element (k, l) in the first slot is not used for cell-specific reference signals.

- In the subframes where an MPDCCH or its associated PDSCH is transmitted in response to a physical random access transmission initiated by a PDCCH order, the UE shall receive the MPDCCH or its associated PDSCH, and assume no other UE-specific reception is needed.
- For MPDCCH transmission associated with C-RNTI or TPC-PUCCH-RNTI or TPC-PUSCH-RNTI or SPS C-RNTI that are not configured to use the Type2-MPDCCH common search space, frequency hopping of the MPDCCH is enabled when higher layer parameter *mpdcch-pdsch-HoppingConfig* is set.
- For MPDCCH transmission associated with PUR C-RNTI using UE-specific MPDCCH search space, frequency hopping of the MPDCCH is enabled when *mpdcch-FreqHopping* in higher layer parameter *PUR-MPDCCH-Config* is set.
- For MPDCCH transmission associated with Type2-MPDCCH common search space, frequency hopping of the MPDCCH is enabled when higher layer parameter *rar-HoppingConfig* is set. Further
 - if PRACH CE level 0 or 1 is used for the last PRACH attempt, $N_{NB}^{ch,DL}$ is set to the higher layer parameter *interval-DIHoppingConfigCommonModeA*;
 - if PRACH CE level 2 or 3 is used for the last PRACH attempt, $N_{NB}^{ch,DL}$ is set to the higher layer parameter *interval-DIHoppingConfigCommonModeB*.
- For MPDCCH transmission associated with SC-RNTI, frequency hopping of the MPDCCH is enabled when higher layer parameter *mpdcch-pdsch-HoppingConfig-SC-MCCH* is set. Further
 - if *mpdcch-pdsch-HoppingConfig-SC-MCCH* is set to CEModeA, $N_{NB}^{ch,DL}$ is set to the higher layer parameter *interval-DIHoppingConfigCommonModeA*;
 - if *mpdcch-pdsch-HoppingConfig-SC-MCCH* is set to CEModeB, $N_{NB}^{ch,DL}$ is set to the higher layer parameter *interval-DIHoppingConfigCommonModeB*.
- For MPDCCH transmission associated with G-RNTI, frequency hopping of the MPDCCH is enabled when higher layer parameter *mpdcch-pdsch-HoppingConfig-SC-MTCH* is set. Further
 - if *mpdcch-pdsch-CEmodeConfig-SC-MTCH* is set to CEModeA, $N_{NB}^{ch,DL}$ is set to the higher layer parameter *interval-DIHoppingConfigCommonModeA*;
 - if *mpdcch-pdsch-CEmodeConfig-SC-MTCH* is set to CEModeB, $N_{NB}^{ch,DL}$ is set to the higher layer parameter *interval-DIHoppingConfigCommonModeB*.
- The narrowband $n_{NB}^{(i_{0,ss})}$ for MPDCCH transmission in the first subframe of MPDCCH search space is provided by higher layers. Starting subframe configuration of a search space where UE monitors an MPDCCH is also provided by higher layers. The MPDCCH search space uses $N_{repss}^{MPDCCH} \geq 1$ subframes, spanning $N_{abs}^{MPDCCH} \geq N_{repss}^{MPDCCH}$ consecutive subframes, including subframes that are not BL/CE DL subframes where the MPDCCH transmission is postponed.
 - If higher layer parameter *resourceReservationDedicatedDL* is configured, then in case of MPDCCH transmission associated with C-RNTI or SPS C-RNTI using UE-specific MPDCCH search space,
 - In a subframe that is fully reserved as defined in clause 7.1 in [4], the MPDCCH transmission is postponed until the next BL/CE downlink subframe that is not fully reserved.
 - In a subframe that is partially reserved, the reserved resource elements shall be counted in the MPDCCH mapping but not used for transmission of the MPDCCH.
 - If frequency hopping is not enabled for MPDCCH, the repetitions of an MPDCCH candidate are located at the same PRB resources in the same narrowband $n_{NB}^{(i_{0,ss})}$, and

- if frequency hopping is enabled for MPDCCH, an MPDCCH candidate shall be transmitted in absolute subframe i using the same PRB resources within each narrowband $n_{\text{NB}}^{(i)}$

$$n_{\text{NB}}^{(i)} = \left(n_{\text{NB}}^{(i_{0,ss})} + \left(\left\lfloor \frac{i + i_{\Delta}}{N_{\text{NB}}^{\text{ch,DL}}} - j_0 \right\rfloor \bmod N_{\text{NB,hop}}^{\text{ch,DL}} \right) \cdot f_{\text{NB,hop}}^{\text{DL}} \right) \bmod N_{\text{NB}}^{\text{DL}}$$

$$j_0 = \left\lfloor (i_{0,ss} + i_{\Delta}) / N_{\text{NB}}^{\text{ch,DL}} \right\rfloor$$

$$i_{0,ss} \leq i \leq i_{0,ss} + N_{\text{abs,ss}}^{\text{MPDCCH}} - 1$$

$$i_{\Delta} = \begin{cases} 0, & \text{for frame structure type 1} \\ N_{\text{NB}}^{\text{ch,DL}} - 2, & \text{for frame structure type 2} \end{cases}$$

where $i_{0,ss}$ is the absolute subframe number of the first downlink subframe of MPDCCH search space, and $N_{\text{NB,hop}}^{\text{ch,DL}}$, $N_{\text{NB}}^{\text{ch,DL}}$ and $f_{\text{NB,hop}}^{\text{DL}}$ are cell-specific higher-layer parameters. The UE shall not expect MPDCCH transmission in absolute subframe i if it is not a BL/CE DL subframe.

- The UE may assume the same precoding matrix being used for a PRB across a block of $N_{\text{NB}}^{\text{ch,DL}}$ consecutive subframes for MPDCCH, where the subframe number of the first subframe in each block of $N_{\text{NB}}^{\text{ch,DL}}$ consecutive subframes, denoted as $n_{\text{abs},1}$ satisfies $(n_{\text{abs},1} + i_{\Delta}) \bmod N_{\text{NB}}^{\text{ch,DL}} = 0$.
- If *crs-ChEstMPDCCH-ConfigCommon* or *crs-ChEstMPDCCH-ConfigDedicated* is configured by higher layers, the relation between the MPDCCH and CRS antenna ports is defined as follows:
 - When one CRS port is configured by the eNB, the antenna port(s) used for MPDCCH transmission are equivalent to CRS port 0.
 - For distributed transmission and when two CRS ports are configured by the eNB, the relation between the symbols transmitted on the antenna ports used for MPDCCH transmission and CRS ports 0 – 1 is defined by the precoder matrix for single-layer transmission in Table 6.3.4.2.3-1 using codebook index 0 for antenna port 107 and codebook index 1 for antenna port 109.
 - For distributed transmission and when four CRS ports are configured by the eNB, in absolute subframe n_{abs} and resource block index n_{PRB} within one or two MPDCCH PRB sets where UE monitors an MPDCCH, the relation between the symbols transmitted on the antenna ports used for MPDCCH transmission and CRS ports 0 – 3 is defined by the precoder matrix for single-layer transmission in Table 6.3.4.2.3-2 using codebook index i for antenna port 107 and codebook index $i + 1$ for antenna port 109, where

$$i = 12 + 2 \left(\left(\left\lfloor \frac{n_{\text{abs}} + i_{\Delta}}{N_{\text{NB}}^{\text{ch,DL}}} \right\rfloor + n_{\text{PRB}} \right) \bmod 2 \right)$$

- For localized transmission, when two CRS ports are configured by the eNB and predefined mapping type is used, in absolute subframe n_{abs} and resource block index n_{PRB} within one or two MPDCCH PRB sets where UE monitors an MPDCCH, the relation between the symbols transmitted on the antenna port used for MPDCCH transmission and CRS ports 0 – 1 is defined by the precoder matrix for single-layer transmission in Table 6.3.4.2.3-1, with codebook index i , where
- $$i = \left(\left\lfloor \frac{n_{\text{abs}} + i_{\Delta}}{N_{\text{NB}}^{\text{ch,DL}}} \right\rfloor + n_{\text{PRB}} \right) \bmod 2$$
- For localized transmission, when four CRS ports are configured by the eNB and predefined mapping type is used, in absolute subframe n_{abs} and resource block index n_{PRB} within one or two MPDCCH PRB sets where UE monitors an MPDCCH, the relation between the symbols transmitted on the antenna port used for MPDCCH transmission and CRS ports 0 – 3 is given by the precoder matrix for single-layer transmission in Table 6.3.4.2.3-2 using codebook index i where

$$i = 12 + \left(\left(\left\lfloor \frac{n_{\text{abs}} + i_{\Delta}}{N_{\text{NB}}^{\text{ch,DL}}} \right\rfloor + \Delta_{\text{PRB}}(n_{\text{PRB}} \bmod 4) \right) \bmod 4 \right)$$

$$[\Delta_{\text{PRB}}(0) \ \Delta_{\text{PRB}}(1) \ \Delta_{\text{PRB}}(2) \ \Delta_{\text{PRB}}(3)] = [0 \ 2 \ 1 \ 3]$$

- For localized transmission and when CSI-based or reciprocity-based mapping type is used, the relation between the symbols transmitted on the antenna port used for MPDCCH transmission and the CRS ports is given in [4]. When it is indicated in [4] that the antenna port is changed for an MPDCCH candidate with aggregation level 2, the antenna port shall be replaced by the antenna port determined for an MPDCCH candidate with aggregation level 4 in the same search space.
- NOTE: $n_{\text{PRB}} = 0, \dots, K - 1$, with $K = 6$ for $N_{\text{RB}}^{\text{Xp}} = 2 + 4$, and $K = N_{\text{RB}}^{\text{Xp}}$ otherwise, where the ordering of PRBs within the PRB set(s) is in increasing order of PRB index.

The UE may assume that an MPDCCH associated with the P-RNTI is transmitted on the set $\{s_j\}$ of narrowbands where $\{s_j\}$ is defined in Clause 6.4.1. For a UE monitoring an MPDCCH associated with the P-RNTI, the first MPDCCH narrowband is given by s_m where $m = (\tilde{N}_{\text{NB}}^{\text{p}} + N_{\text{ID}}^{\text{cell}}) \bmod N_{\text{NB}}^{\text{s}}$, $\tilde{N}_{\text{NB}}^{\text{p}} \in \{0, 1, \dots, N_{\text{NB}}^{\text{p}} - 1\}$ is the Paging Narrowband (PN) obtained according to [10], and N_{NB}^{p} is the higher-layer parameter *paging-narrowBands*.

- If the higher-layer parameter *si-HoppingConfigCommon* disables frequency hopping for an MPDCCH associated with P-RNTI, each MPDCCH candidate shall be located in the same PRB in narrowband s_m where $m = (\tilde{N}_{\text{NB}}^{\text{p}} + N_{\text{ID}}^{\text{cell}}) \bmod N_{\text{NB}}^{\text{s}}$.
- If the higher-layer parameter *si-HoppingConfigCommon* enables frequency hopping for an MPDCCH with P-RNTI, an MPDCCH candidate shall be located in narrowband s_j in absolute subframe i using the same PRB resources within each narrowband s_j where

$$j = \left(\left(\tilde{N}_{\text{NB}}^{\text{p}} + N_{\text{ID}}^{\text{cell}} \right) + \left(\left\lfloor \frac{i + i_{\Delta}}{N_{\text{NB}}^{\text{ch,DL}}} - j_0 \right\rfloor \bmod N_{\text{NB,hop}}^{\text{ch,DL}} \right) \cdot f_{\text{NB,hop}}^{\text{DL}} \right) \bmod N_{\text{NB}}^{\text{s}}$$

$$j_0 = \left\lfloor (i_{0,ss} + i_{\Delta}) / N_{\text{NB}}^{\text{ch,DL}} \right\rfloor$$

$$i_{0,ss} \leq i \leq i_{0,ss} + N_{\text{abs,ss}}^{\text{MPDCCH}} - 1$$

$$i_{\Delta} = \begin{cases} 0, & \text{for frame structure type 1} \\ N_{\text{NB}}^{\text{ch,DL}} - 2, & \text{for frame structure type 2} \end{cases}$$

where $i_{0,ss}$ is the absolute subframe number of the first downlink subframe of MPDCCH search space

according to locations of paging opportunity subframes, and $N_{\text{NB,hop}}^{\text{ch,DL}}$, $N_{\text{NB}}^{\text{ch,DL}}$ and $f_{\text{NB,hop}}^{\text{DL}}$ are cell-specific higher-layer parameters. For MPDCCH associated with P-RNTI, if *interval-DIHoppingConfigCommonModeB* is signalled in SIB1-BR, then the frequency hopping granularity $N_{\text{NB}}^{\text{ch,DL}}$ is set to *interval-DIHoppingConfigCommonModeB*; otherwise, $N_{\text{NB}}^{\text{ch,DL}}$ is set to *interval-DIHoppingConfigCommonModeA* signalled in SIB1-BR.

The UE shall not expect MPDCCH transmission in absolute subframe i if it is not a BL/CE DL subframe.

6.8C Short physical downlink control channel (SPDCCH)

6.8C.1 SPDCCH formats

The short physical downlink control channel (SPDCCH) carries scheduling assignments and other control information for subslot PDSCH, slot-PDSCH, subslot-PUSCH, and slot-PUSCH. A SPDCCH is transmitted using an aggregation of

one or several consecutive short control channel elements (SCCEs) where each SCCE consists of multiple short resource element groups (SREGs), defined in clause 6.2.4B. The number of resource elements used for one SPDCCH depends on the SPDCCH format as given by Table 6.8C.1-2 and the number of SREGs per SCCE is given by Table 6.8C.1-1.

Table 6.8C.1-1: Number of SREGs per SCCE, $N_{\text{SREG}}^{\text{SCCE}}$

	$N_{\text{SREG}}^{\text{SCCE}}$
CRS based SPDCCH	4
DMRS based SPDCCH	4 for a 2-symbol SPDCCH ¹ 6 for a 3-symbol SPDCCH ¹
NOTE 1: see table 6.8C.5-1 and table 6.8C.5-2	

Table 6.8C.1-2: Supported SPDCCH formats

SPDCCH format	Number of SCCEs for one SPDCCH, $N_{\text{SCCE}}^{\text{SPDCCH}}$
0	1
1	2
2	4
3	8

A UE shall monitor multiple SPDCCHs as defined in 3GPP TS 36.213 [4]. One or two resource sets which a UE shall monitor for SPDCCH transmissions in a slot/subslot can be configured. The SPDCCH can use either localized or distributed transmission. All SPDCCH candidates in SPDCCH set X_m use either only localized or only distributed transmission as configured by higher layers (see *transmissionType* in 3GPP TS 36.331 [9]). Similarly, all SPDCCH candidates in SPDCCH set X_m use either only CRS-based demodulation or only DMRS-based demodulation as configured by higher layers (see *spdcch-SetReferenceSig* in 3GPP TS 36.331 [9]). For a resource set with CRS-based SPDCCH, the distributed transmission is implemented at the SREG level, i.e. in the SCCE-to-SREG mapping. For a resource set with DMRS-based SPDCCH, the distributed transmission is implemented at the SCCE level, i.e. in the SPDCCH candidate-to-SCCE mapping.

The number of OFDM symbols spanned by a SPDCCH resource set X_m configured with CRS based demodulation can be configured to be one or two.

For slot based transmission, the number of OFDM symbols spanned by each SPDCCH candidate of a resource set X_m configured with DMRS-based demodulation is fixed to 2. For subslot based transmission, the number of OFDM symbols spanned by each SPDCCH candidate of a resource set X_m configured with DMRS-based demodulation is equal to the number of OFDM symbols used for the subslot based PDSCH transmission (which depends on the starting symbol index, as specified in Table 6.4.2-1).

The physical resource blocks in frequency domain constituting SPDCCH set X_m are in this paragraph assumed to be numbered in ascending order from 0 to $N_{\text{RB}}^{X_m} - 1$. For a CRS-based SPDCCH, SREGs within an SPDCCH set x_m are numbered in a frequency-first time-second manner from 0 to $N_{\text{os}}^{x_m} N_{\text{RB}}^{x_m} - 1$, where $N_{\text{os}}^{x_m}$ is the number of configured OFDM symbols (OS). The frequency-first, time-second mapping of the SREGs within a SPDCCH set is performed from the lowest resource block in frequency domain to the highest resource blocks in frequency domain for the first symbol, and from the highest resource block in frequency domain to the lowest resource block in frequency domain for the second symbol. For a DMRS-based SPDCCH, SREGs within an SPDCCH set x_m are numbered in a time-first frequency-second manner from 0 to $N_{\text{os}}^{x_m} N_{\text{RB}}^{x_m} - 1$.

Within CRS-based SPDCCH set X_m , the SCCEs available for transmission of SPDCCHs are numbered from 0 to

$N_{SCCE,m} - 1$ where $N_{SCCEm} = \lfloor N_{OS}^{X_m} N_{RB}^{X_m} / N_{SREG}^{SCCE} \rfloor$ for localized mapping and $N_{SCCEm} = N_{OS}^{X_m} \lfloor N_{RB}^{X_m} / N_{SREG}^{SCCE} \rfloor$ for distributed mapping. Within DMRS-based SPDCCH set X_m , the SCCEs available for transmission of SPDCCHs are numbered from 0 to $N_{SCCE,m} - 1$ where $N_{SCCEm} = \lfloor N_{OS}^{X_m} N_{RB}^{X_m} / N_{SREG}^{SCCE} \rfloor$. The SCCE number n corresponds

- SREGs numbered $n \cdot N_{SREG}^{SCCE} + j$ for localized SPDCCH mapping with CRS and DMRS based demodulation and for distributed SPDCCH mapping with DMRS-based demodulation

- SREGs numbered $n \bmod \left\lfloor \frac{N_{RB}^{X_m}}{N_{SREG}^{SCCE}} \right\rfloor + \left\lfloor \frac{n}{\left\lfloor \frac{N_{RB}^{X_m}}{N_{SREG}^{SCCE}} \right\rfloor} \right\rfloor \cdot N_{RB}^{X_m} + j \cdot \left\lfloor \frac{N_{RB}^{X_m}}{N_{SREG}^{SCCE}} \right\rfloor$ for distributed SPDCCH mapping with CRS-

based demodulation.

where $j = 0, \dots, N_{SREG}^{SCCE} - 1$ and N_{SREG}^{SCCE} is the number of SREGs per SCCE.

NOTE: $N_{RB}^{X_m}$ represents the number of SREGs per each configured OFDM symbol in the SPDCCH resource set X_m and $N_{os}^{X_m} N_{RB}^{X_m}$ is the total number of SREGs in SPDCCH resource set X_m .

6.8C.2 Scrambling

The block of bits $b(0), \dots, b(M_{\text{bit}} - 1)$ to be transmitted on a SPDCCH in a subframe shall be scrambled, resulting in a block of scrambled bits $\tilde{b}(0), \dots, \tilde{b}(M_{\text{bit}} - 1)$ according to

$$\tilde{b}(i) = (b(i) + c(i)) \bmod 2$$

where the UE-specific scrambling sequence $c(i)$ is given by clause 7.2. The scrambling sequence generator shall be initialized with $c_{\text{init}} = \lfloor n_s / 2 \rfloor \cdot 2^9 + n_{\text{ID},m}^{\text{SPDCCH}}$ where m is the SPDCCH resource set number.

6.8C.3 Modulation

The block of scrambled bits $\tilde{b}(0), \dots, \tilde{b}(M_{\text{tot}} - 1)$ shall be modulated as described in clause 7.1, resulting in a block of complex-valued modulation symbols $d(0), \dots, d(M_{\text{ymb}} - 1)$. Table 6.8C.3-1 specifies the modulation mappings applicable for the physical downlink control channel.

Table 6.8C.3-1: SPDCCH modulation schemes

Physical channel	Modulation schemes
SPDCCH	QPSK

6.8C.4 Layer mapping and precoding

In case of CRS based SPDCCH, layer mapping and precoding shall be done according to clause 6.8.4 with PDCCH replaced by SPDCCH.

In case of DMRS based SPDCCH the layer mapping and precoding shall be done according to clause 6.8A.4.

6.8C.5 Mapping to resource elements

The mapping to resource elements is defined by operations on vectors of complex-valued symbols. Let

$y(i) = [y^{(0)}(i) \dots y^{(P-1)}(i)]^T$ denotes symbol vector i and $y^{(p)}(i)$ represents the signal for antenna port p .

The block of vectors $y(i) = [y^{(0)}(i) \dots y^{(P-1)}(i)]^T$, $i = 0, \dots, M_{\text{symb}} - 1$ shall be mapped in sequence starting with $y(0)$ to resource elements (k, l) on the associated antenna port(s) which meet all of the following criteria:

- they are part of the SREGs assigned for the SPDCCH transmission, and
- they are assumed by the UE not to be used for cell-specific reference signals, where the positions of the cell-specific reference signals are given by clause 6.10.1.2 with the number of antenna ports and the frequency shift of cell-specific reference signals derived as described in clause 6.10.1.2 unless other values for these parameters are provided by clause 9.1.4.3 in 3GPP TS 36.213 [4], and
- they are assumed by the UE not to be used for transmission of:
 - UE-specific reference signal associated with SPDCCH
 - zero-power CSI reference signals, where the positions of the CSI reference signals are given by clause 6.10.5.2. The configuration for zero power CSI reference signals is
 - obtained as described in clause 6.10.5.2 unless other values are provided by clause 9.1.4.3 in 3GPP TS 36.213 [4], and
 - obtained by higher-layer configuration of up to five reserved CSI-RS resources as part of the discovery signal configuration following the procedure for zero-power CSI-RS in clause 6.10.5.2.
 - non-zero-power CSI reference signals for CSI reporting with the configuration for non-zero power CSI reference signals for CSI reporting obtained as described in clause 6.10.5.2.
- The set of indices of l where the SPDCCH can be mapped to is dependent on if slot or subslot based SPDCCH is used, the subslot number, if CRS or DMRS based SPDCCH is configured and the number of symbols used for PDCCH. In case CRS based SPDCCH is configured, the set of indices is also dependent on the number of symbols, $N_{\text{CRS}}^{\text{SPDCCH}}$, configured by higher layers (see *spdcch-NoOfSymbols* in 3GPP TS 36.331 [9]), that the SPDCCH is mapped over.
 - For slot-SPDCCH and for frame structure type 1 and 2, the set of indices of l for the second slot in the subframe is given in Table 6.8C.5-1. It can be noted that no SPDCCH is transmitted in the first slot of the subframe, where the DCI instead is carried in PDCCH, see [3].
 - For subslot-SPDCCH and for frame structure type 1, the set of indices of l for a given downlink subslot number in a subframe is given in Table 6.8C.5-2. It can be noted that for subslot number 0 where no SPDCCH is transmitted, and the DCI is instead carried in PDCCH, see [3].

If $y(i)$ has been precoded according to clause 6.3.4.3 and if there is an uneven number of resource elements per PRB that fulfil all the above criteria, $y(i)$ is not mapped to the resource element of the PRB with largest k .

Resource elements belonging to synchronization signals, the core part of PBCH, PBCH repetitions, or resource elements reserved for reference signals in the mapping operation of PBCH but not used for transmission of reference signals, shall be assumed available in the SPDCCH mapping but not used for transmission of SPDCCH.

NOTE: For DMRS based SPDCCH, the UE is not required to use the PRGs of size 2 (see 3GPP TS 36.213 [4]) which is/are partially overlapped with PBCH/PSS/SSS for SPDCCH monitoring.

For DMRS based SPDCCH, the mapping to resource elements (k, l) on antenna port p , meeting the criteria above, shall be in increasing order of first the index k and then the index l .

For localized and distributed CRS based SPDCCH, the SREGs of a SPDCCH candidate are first interleaved according to step 1 below and then the modulated symbols are mapped to resource elements (k, l) of the interleaved SREGs according to step 2 below.

- Step 1: Perform a block interleaver on the SREGs building the SPDCCH candidate, where the number of rows equal to the number of SCCEs for the SPDCCH candidate and the number of columns equal to 4 (i.e. the number of SREGs in an SCCE). The SREGs are written into the matrix row by row and read out column by column.
- Step 2: The modulated symbols are mapped in sequence starting with $y^{(p)}(0)$ to resource elements (k,l) on antenna port p in increasing order of the index k , meeting the criteria above, over the interleaved SREGs in the order given by the block interleaver of step 1.

Table 6.8C.5-1: Set of indices of l for slot-SPDCCH

DMRS based SPDCCH	CRS based SPDCCH	
	$N_{CRS}^{SPDCCH} = 1$	$N_{CRS}^{SPDCCH} = 2$
{0,1}	{0}	{0,1}

Table 6.8C.5-2: Set of indices of l for subslot-SPDCCH

Number of symbols used for PDCCH	Subslot index	Set of indices of l		
		DMRS based SPDCCH	CRS based SPDCCH	
			$N_{CRS}^{SPDCCH} = 1$	$N_{CRS}^{SPDCCH} = 2$
1 or 3	1	{3,4}	{3}	{3,4}
2	1	{2,3,4}	{2}	{2,3}
1, 2 or 3	2	{5,6}	{5}	{5,6}
1, 2 or 3	3	{0,1}	{0}	{0,1}
1, 2 or 3	4	{2,3}	{2}	{2,3}
1, 2 or 3	5	{4,5,6}	{4}	{4,5}

6.9 Physical hybrid ARQ indicator channel

The PHICH carries the hybrid-ARQ ACK/NACK. Multiple PHICHs mapped to the same set of resource elements constitute a PHICH group, where PHICHs within the same PHICH group are separated through different orthogonal sequences. A PHICH resource is identified by the index pair $(n_{PHICH}^{group}, n_{PHICH}^{seq})$, where n_{PHICH}^{group} is the PHICH group number and n_{PHICH}^{seq} is the orthogonal sequence index within the group.

For frame structure type 1 and type 3, the number of PHICH groups N_{PHICH}^{group} is constant in all subframes and given by

$$N_{PHICH}^{group} = \begin{cases} \lceil N_g (N_{RB}^{DL}/8) \rceil & \text{for normal cyclic prefix} \\ 2 \cdot \lceil N_g (N_{RB}^{DL}/8) \rceil & \text{for extended cyclic prefix} \end{cases}$$

where $N_g \in \{1/6, 1/2, 1, 2\}$ is provided by higher layers. The index n_{PHICH}^{group} ranges from 0 to $N_{PHICH}^{group} - 1$.

For frame structure type 2, the number of PHICH groups may vary between subframes and is given by $m_i \cdot N_{PHICH}^{group}$ where N_{PHICH}^{group} is given by the expression above and m_i is given by Table 6.9-1 with the uplink-downlink configuration provided by the higher-layer parameter *subframeAssignment*. The index n_{PHICH}^{group} in a subframe with non-zero PHICH resources ranges from 0 to $m_i \cdot N_{PHICH}^{group} - 1$.

Table 6.9-1: The factor m_i for frame structure type 2

Uplink-downlink configuration	Subframe number i									
	0	1	2	3	4	5	6	7	8	9
0	2	1	0	0	0	2	1	0	0	0
1	0	1	0	0	1	0	1	0	0	1
2	0	0	0	1	0	0	0	0	1	0

3	1	0	0	0	0	0	0	0	1	1
4	0	0	0	0	0	0	0	0	1	1
5	0	0	0	0	0	0	0	0	1	0
6	1	1	0	0	0	1	1	0	0	1

6.9.1 Modulation

The block of bits $b(0), \dots, b(M_{\text{bit}} - 1)$ transmitted on one PHICH in one subframe shall be modulated as described in clause 7.1, resulting in a block of complex-valued modulation symbols $z(0), \dots, z(M_s - 1)$, where $M_s = M_{\text{bit}}$. Table 6.9.1-1 specifies the modulation mappings applicable for the physical hybrid ARQ indicator channel.

Table 6.9.1-1: PHICH modulation schemes.

Physical channel	Modulation schemes
PHICH	BPSK

The block of modulation symbols $z(0), \dots, z(M_s - 1)$ shall be symbol-wise multiplied with an orthogonal sequence and scrambled, resulting in a sequence of modulation symbols $d(0), \dots, d(M_{\text{symb}} - 1)$ according to

$$d(i) = w(i \bmod N_{\text{SF}}^{\text{PHICH}}) \cdot (1 - 2c(i)) \cdot z(\lfloor i / N_{\text{SF}}^{\text{PHICH}} \rfloor)$$

where

$$i = 0, \dots, M_{\text{symb}} - 1$$

$$M_{\text{symb}} = N_{\text{SF}}^{\text{PHICH}} \cdot M_s$$

$$N_{\text{SF}}^{\text{PHICH}} = \begin{cases} 4 & \text{normal cyclic prefix} \\ 2 & \text{extended cyclic prefix} \end{cases}$$

and $c(i)$ is a cell-specific scrambling sequence generated according to clause 7.2. The scrambling sequence generator shall be initialised with $c_{\text{init}} = (\lfloor n_s / 2 \rfloor + 1) \cdot (2N_{\text{ID}}^{\text{cell}} + 1) \cdot 2^9 + N_{\text{ID}}^{\text{cell}}$ at the start of each subframe.

The sequence $[w(0) \ \dots \ w(N_{\text{SF}}^{\text{PHICH}} - 1)]$ is given by Table 6.9.1-2 where the sequence index $n_{\text{PHICH}}^{\text{seq}}$ corresponds to the PHICH number within the PHICH group.

Table 6.9.1-2: Orthogonal sequences $[w(0) \ \dots \ w(N_{\text{SF}}^{\text{PHICH}} - 1)]$ for PHICH

Sequence index $n_{\text{PHICH}}^{\text{seq}}$	Orthogonal sequence	
	Normal cyclic prefix $N_{\text{SF}}^{\text{PHICH}} = 4$	Extended cyclic prefix $N_{\text{SF}}^{\text{PHICH}} = 2$
0	[+1 +1 +1 +1]	[+1 +1]
1	[+1 -1 +1 -1]	[+1 -1]
2	[+1 +1 -1 -1]	[+j +j]
3	[+1 -1 -1 +1]	[+j -j]
4	[+j +j +j +j]	-
5	[+j -j +j -j]	-
6	[+j +j -j -j]	-
7	[+j -j -j +j]	-

6.9.2 Resource group alignment, layer mapping and precoding

The block of symbols $d(0), \dots, d(M_{\text{symb}} - 1)$ should be first aligned with resource element group size, resulting in a block of symbols $d^{(0)}(0), \dots, d^{(0)}(c \cdot M_{\text{symb}} - 1)$, where $c = 1$ for normal cyclic prefix; and $c = 2$ for extended cyclic prefix.

For normal cyclic prefix, $d^{(0)}(i) = d(i)$, for $i = 0, \dots, M_{\text{symb}} - 1$.

For extended cyclic prefix,

$$\begin{bmatrix} d^{(0)}(4i) & d^{(0)}(4i+1) & d^{(0)}(4i+2) & d^{(0)}(4i+3) \end{bmatrix}^T = \begin{cases} \begin{bmatrix} d(2i) & d(2i+1) & 0 & 0 \end{bmatrix}^T & n_{\text{PHICH}}^{\text{group}} \bmod 2 = 0 \\ \begin{bmatrix} 0 & 0 & d(2i) & d(2i+1) \end{bmatrix}^T & n_{\text{PHICH}}^{\text{group}} \bmod 2 = 1 \end{cases}$$

for $i = 0, \dots, (M_{\text{symb}}/2) - 1$.

The block of symbols $d^{(0)}(0), \dots, d^{(0)}(c \cdot M_{\text{symb}} - 1)$ shall be mapped to layers and precoded, resulting in a block of vectors $y(i) = [y^{(0)}(i) \ \dots \ y^{(P-1)}(i)]^T$, $i = 0, \dots, c \cdot M_{\text{symb}} - 1$, where $y^{(p)}(i)$ represents the signal for antenna port p , $p = 0, \dots, P - 1$ and the number of cell-specific reference signals $P \in \{1, 2, 4\}$. The layer mapping and precoding operation depends on the cyclic prefix length and the number of antenna ports used for transmission of the PHICH. The PHICH shall be transmitted on the same set of antenna ports as the PBCH.

For transmission on a single antenna port, $P = 1$, layer mapping and precoding are defined by clauses 6.3.3.1 and 6.3.4.1, respectively, with $M_{\text{symb}}^{(0)} = c \cdot M_{\text{symb}}$.

For transmission on two antenna ports, $P = 2$, layer mapping and precoding are defined by clauses 6.3.3.3 and 6.3.4.3, respectively, with $M_{\text{symb}}^{(0)} = c \cdot M_{\text{symb}}$.

For transmission on four antenna ports, $P = 4$, layer mapping is defined by clause 6.3.3.3 with $M_{\text{symb}}^{(0)} = c \cdot M_{\text{symb}}$ and precoding by

$$\begin{bmatrix} y^{(0)}(4i) \\ y^{(1)}(4i) \\ y^{(2)}(4i) \\ y^{(3)}(4i) \\ y^{(0)}(4i+1) \\ y^{(1)}(4i+1) \\ y^{(2)}(4i+1) \\ y^{(3)}(4i+1) \\ y^{(0)}(4i+2) \\ y^{(1)}(4i+2) \\ y^{(2)}(4i+2) \\ y^{(3)}(4i+2) \\ y^{(0)}(4i+3) \\ y^{(1)}(4i+3) \\ y^{(2)}(4i+3) \\ y^{(3)}(4i+3) \end{bmatrix} = \frac{1}{\sqrt{2}} \begin{bmatrix} 1 & 0 & 0 & 0 & j & 0 & 0 & 0 \\ 0 & 0 & 0 & 0 & 0 & 0 & 0 & 0 \\ 0 & -1 & 0 & 0 & 0 & j & 0 & 0 \\ 0 & 0 & 0 & 0 & 0 & 0 & 0 & 0 \\ 0 & 1 & 0 & 0 & 0 & j & 0 & 0 \\ 0 & 0 & 0 & 0 & 0 & 0 & 0 & 0 \\ 1 & 0 & 0 & 0 & -j & 0 & 0 & 0 \\ 0 & 0 & 0 & 0 & 0 & 0 & 0 & 0 \\ 0 & 0 & 1 & 0 & 0 & 0 & j & 0 \\ 0 & 0 & 0 & 0 & 0 & 0 & 0 & 0 \\ 0 & 0 & 0 & -1 & 0 & 0 & 0 & j \\ 0 & 0 & 0 & 0 & 0 & 0 & 0 & 0 \\ 0 & 0 & 0 & 1 & 0 & 0 & 0 & j \\ 0 & 0 & 0 & 0 & 0 & 0 & 0 & 0 \\ 0 & 0 & 1 & 0 & 0 & 0 & -j & 0 \\ 0 & 0 & 0 & 0 & 0 & 0 & 0 & 0 \end{bmatrix} \begin{bmatrix} \text{Re}\{x^{(0)}(i)\} \\ \text{Re}\{x^{(1)}(i)\} \\ \text{Re}\{x^{(2)}(i)\} \\ \text{Re}\{x^{(3)}(i)\} \\ \text{Im}\{x^{(0)}(i)\} \\ \text{Im}\{x^{(1)}(i)\} \\ \text{Im}\{x^{(2)}(i)\} \\ \text{Im}\{x^{(3)}(i)\} \end{bmatrix}$$

if $(i + n_{\text{PHICH}}^{\text{group}}) \bmod 2 = 0$ for normal cyclic prefix, or $(i + \lfloor n_{\text{PHICH}}^{\text{group}}/2 \rfloor) \bmod 2 = 0$ for extended cyclic prefix, where $n_{\text{PHICH}}^{\text{group}}$ is the PHICH group number and $i = 0, 1, 2$, and by

$$\begin{bmatrix}
y^{(0)}(4i) \\
y^{(1)}(4i) \\
y^{(2)}(4i) \\
y^{(3)}(4i) \\
y^{(0)}(4i+1) \\
y^{(1)}(4i+1) \\
y^{(2)}(4i+1) \\
y^{(3)}(4i+1) \\
y^{(0)}(4i+2) \\
y^{(1)}(4i+2) \\
y^{(2)}(4i+2) \\
y^{(3)}(4i+2) \\
y^{(0)}(4i+3) \\
y^{(1)}(4i+3) \\
y^{(2)}(4i+3) \\
y^{(3)}(4i+3)
\end{bmatrix}
= \frac{1}{\sqrt{2}}
\begin{bmatrix}
0 & 0 & 0 & 0 & 0 & 0 & 0 & 0 \\
1 & 0 & 0 & 0 & j & 0 & 0 & 0 \\
0 & 0 & 0 & 0 & 0 & 0 & 0 & 0 \\
0 & -1 & 0 & 0 & 0 & j & 0 & 0 \\
0 & 0 & 0 & 0 & 0 & 0 & 0 & 0 \\
0 & 1 & 0 & 0 & 0 & j & 0 & 0 \\
0 & 0 & 0 & 0 & 0 & 0 & 0 & 0 \\
1 & 0 & 0 & 0 & -j & 0 & 0 & 0 \\
0 & 0 & 0 & 0 & 0 & 0 & 0 & 0 \\
0 & 0 & 1 & 0 & 0 & 0 & j & 0 \\
0 & 0 & 0 & 0 & 0 & 0 & 0 & 0 \\
0 & 0 & 0 & -1 & 0 & 0 & 0 & j \\
0 & 0 & 0 & 0 & 0 & 0 & 0 & 0 \\
0 & 0 & 0 & 1 & 0 & 0 & 0 & j \\
0 & 0 & 0 & 0 & 0 & 0 & 0 & 0 \\
0 & 0 & 1 & 0 & 0 & 0 & -j & 0
\end{bmatrix}
\begin{bmatrix}
\text{Re}\{x^{(0)}(i)\} \\
\text{Re}\{x^{(1)}(i)\} \\
\text{Re}\{x^{(2)}(i)\} \\
\text{Re}\{x^{(3)}(i)\} \\
\text{Im}\{x^{(0)}(i)\} \\
\text{Im}\{x^{(1)}(i)\} \\
\text{Im}\{x^{(2)}(i)\} \\
\text{Im}\{x^{(3)}(i)\}
\end{bmatrix}$$

otherwise for $i = 0,1,2$.

6.9.3 Mapping to resource elements

The sequence $\bar{y}^{(p)}(0), \dots, \bar{y}^{(p)}(M_{\text{symp}}^{(0)} - 1)$ for each of the PHICH groups is defined by

$$\bar{y}^{(p)}(n) = \sum y_i^{(p)}(n)$$

where the sum is over all PHICHs in the PHICH group and $y_i^{(p)}(n)$ represents the symbol sequence from the i :th PHICH in the PHICH group.

PHICH groups are mapped to PHICH mapping units.

For normal cyclic prefix, the mapping of PHICH group m to PHICH mapping unit m' is defined by

$$\tilde{y}_{m'}^{(p)}(n) = \bar{y}_m^{(p)}(n)$$

where

$$m' = m = \begin{cases} 0, 1, \dots, N_{\text{PHICH}}^{\text{group}} - 1 & \text{for frame structure type 1 and type 3} \\ 0, 1, \dots, m_i \cdot N_{\text{PHICH}}^{\text{group}} - 1 & \text{for frame structure type 2} \end{cases}$$

and where m_i is given by Table 6.9-1.

For extended cyclic prefix, the mapping of PHICH group m and $m+1$ to PHICH mapping unit m' is defined by

$$\tilde{y}_{m'}^{(p)}(n) = \bar{y}_m^{(p)}(n) + \bar{y}_{m+1}^{(p)}(n)$$

where

$$m' = m / 2$$

$$m = \begin{cases} 0, 2, \dots, N_{\text{PHICH}}^{\text{group}} - 2 & \text{for frame structure type 1} \\ 0, 2, \dots, m_i \cdot N_{\text{PHICH}}^{\text{group}} - 2 & \text{for frame structure type 2} \end{cases}$$

and where m_i is given by Table 6.9-1.

Let $z^{(p)}(i) = \langle \tilde{y}^{(p)}(4i), \tilde{y}^{(p)}(4i+1), \tilde{y}^{(p)}(4i+2), \tilde{y}^{(p)}(4i+3) \rangle$, $i = 0,1,2$ denote symbol quadruplet i for antenna port p .

Mapping to resource elements is defined in terms of symbol quadruplets according to steps 1–10 below:

- 1) For each value of I'
- 2) Let $n_{I'}$ denote the number of resource element groups not assigned to PCFICH in OFDM symbol I'
- 3) Number the resource-element groups not assigned to PCFICH in OFDM symbol I' from 0 to $n_{I'} - 1$, starting from the resource-element group with the lowest frequency-domain index.
- 4) Initialize $m' = 0$ (PHICH mapping unit number)
- 5) For each value of $i = 0,1,2$
- 6) Symbol-quadruplet $z^{(p)}(i)$ from PHICH mapping unit m' is mapped to the resource-element group represented by $(k', l')_i$ as defined in clause 6.2.4 where the indices k'_i and l'_i are given by steps 7 and 8 below:
- 7) The time-domain index l'_i is given by

$$l'_i = \begin{cases} 0 & \text{normal PHICH duration, all subframes} \\ \lfloor m'/2 \rfloor + i + 1 \pmod 2 & \text{extended PHICH duration, MBSFN subframes} \\ \lfloor m'/2 \rfloor + i + 1 \pmod 2 & \text{extended PHICH duration, subframe 1 and 6 in frame structure type 2} \\ \lfloor m'/2 \rfloor + i + 1 \pmod 2 & \text{extended PHICH duration,} \\ i & \text{subframe with the same duration as the DwPTS duration of a special subframe configuration in frame structure type 3} \\ i & \text{otherwise} \end{cases}$$

- 8) Set the frequency-domain index k'_i to the resource-element group assigned the number \bar{n}_i in step 3 above, where \bar{n}_i is given by

$$\bar{n}_i = \begin{cases} \left(\lfloor N_{\text{ID}}^{\text{cell}} \cdot n_{I'} / n_1 \rfloor + m' \right) \pmod{n_{I'}} & i = 0 \\ \left(\lfloor N_{\text{ID}}^{\text{cell}} \cdot n_{I'} / n_1 \rfloor + m' + \lfloor n_{I'} / 3 \rfloor \right) \pmod{n_{I'}} & i = 1 \\ \left(\lfloor N_{\text{ID}}^{\text{cell}} \cdot n_{I'} / n_1 \rfloor + m' + \lfloor 2n_{I'} / 3 \rfloor \right) \pmod{n_{I'}} & i = 2 \end{cases}$$

in case of extended PHICH duration in MBSFN subframes, or extended PHICH duration in subframes 1 and 6 for frame structure type 2, or extended PHICH duration in subframe with the same duration as the DwPTS duration of a special subframe configuration in frame structure type 3 and by

$$\bar{n}_i = \begin{cases} \left(\lfloor N_{\text{ID}}^{\text{cell}} \cdot n_{I'} / n_0 \rfloor + m' \right) \pmod{n_{I'}} & i = 0 \\ \left(\lfloor N_{\text{ID}}^{\text{cell}} \cdot n_{I'} / n_0 \rfloor + m' + \lfloor n_{I'} / 3 \rfloor \right) \pmod{n_{I'}} & i = 1 \\ \left(\lfloor N_{\text{ID}}^{\text{cell}} \cdot n_{I'} / n_0 \rfloor + m' + \lfloor 2n_{I'} / 3 \rfloor \right) \pmod{n_{I'}} & i = 2 \end{cases}$$

otherwise.

- 9) Increase m' by 1.
- 10) Repeat from step 5 until all PHICH mapping units have been assigned.

The PHICH duration is configurable by higher layers according to Table 6.9.3-1.

The PHICH shall not be transmitted in MBSFN subframes with zero-size non-MBSFN region.

Table 6.9.3-1: PHICH duration in MBSFN and non-MBSFN subframes

PHICH duration	Non-MBSFN subframes			MBSFN subframes
	Subframes 1 and 6 in case of frame structure type 2	Subframe with the same duration as the DwPTS duration of a special subframe configuration in case of frame structure type 3	All other cases	
Normal	1	1	1	1
Extended	2	2	3	2

6.10 Reference signals

Six types of downlink reference signals are defined:

- Cell-specific Reference Signal (CRS)
- MBSFN reference signal
- UE-specific Reference Signal (DM-RS) associated with PDSCH
- DeModulation Reference Signal (DM-RS) associated with EPDCCH or MPDCCH
- Positioning Reference Signal (PRS)
- CSI Reference Signal (CSI-RS)

There is one reference signal transmitted per downlink antenna port.

6.10.1 Cell-specific Reference Signal (CRS)

The UE may assume cell-specific reference signals are, unless otherwise stated in [4, clause 12], transmitted in

- all downlink subframes for frame structure type 1,
- all downlink subframes and DwPTS for frame structure type 2,
- non-empty subframes for frame structure type 3

in a cell supporting PDSCH transmission.

If special subframe configuration 10 is configured by the higher layer signalling *ssp10-CRS-LessDwPTS*, the UE cannot assume that cell specific reference signals are transmitted in the 5th OFDM symbol of the special subframe.

Cell-specific reference signals are transmitted on one or several of antenna ports 0 to 3.

Cell-specific reference signals are transmitted in subframes where $\Delta f = 15$ kHz only.

6.10.1.1 Sequence generation

The reference-signal sequence $r_{l,n_s}(m)$ is defined by

$$r_{l,n_s}(m) = \frac{1}{\sqrt{2}}(1 - 2 \cdot c(2m)) + j \frac{1}{\sqrt{2}}(1 - 2 \cdot c(2m+1)), \quad m = 0, 1, \dots, 2N_{\text{RB}}^{\text{max,DL}} - 1$$

where n_s is the slot number within a radio frame and l is the OFDM symbol number within the slot. The pseudo-random sequence $c(i)$ is defined in clause 7.2. The pseudo-random sequence generator shall be initialised with $c_{\text{init}} = 2^{10} \cdot (7 \cdot (n'_s + 1) + l + 1) \cdot (2 \cdot N_{\text{ID}}^{\text{cell}} + 1) + 2 \cdot N_{\text{ID}}^{\text{cell}} + N_{\text{CP}}$ at the start of each OFDM symbol where

$$n'_s = \begin{cases} 10 \lfloor n_s / 10 \rfloor + n_s \bmod 2 & \text{for frame structure type 3 when the CRS is part of a DRS} \\ n_s & \text{otherwise} \end{cases}$$

$$N_{\text{CP}} = \begin{cases} 1 & \text{for normal CP} \\ 0 & \text{for extended CP} \end{cases}$$

6.10.1.2 Mapping to resource elements

The reference signal sequence $r_{l,n_s}(m)$ shall be mapped to complex-valued modulation symbols $a_{k,l}^{(p)}$ used as reference symbols for antenna port p in slot n_s according to

$$a_{k,l}^{(p)} = r_{l,n_s}(m')$$

where

$$k = 6m + (v + v_{\text{shift}}) \bmod 6$$

$$l = \begin{cases} 0, N_{\text{symp}}^{\text{DL}} - 3 & \text{if } p \in \{0,1\} \\ 1 & \text{if } p \in \{2,3\} \end{cases}$$

$$m = 0, 1, \dots, 2 \cdot N_{\text{RB}}^{\text{DL}} - 1$$

$$m' = m + N_{\text{RB}}^{\text{max,DL}} - N_{\text{RB}}^{\text{DL}}$$

The variables v and v_{shift} define the position in the frequency domain for the different reference signals where v is given by

$$v = \begin{cases} 0 & \text{if } p = 0 \text{ and } l = 0 \\ 3 & \text{if } p = 0 \text{ and } l \neq 0 \\ 3 & \text{if } p = 1 \text{ and } l = 0 \\ 0 & \text{if } p = 1 \text{ and } l \neq 0 \\ 3(n_s \bmod 2) & \text{if } p = 2 \\ 3 + 3(n_s \bmod 2) & \text{if } p = 3 \end{cases}$$

The cell-specific frequency shift is given by $v_{\text{shift}} = N_{\text{ID}}^{\text{cell}} \bmod 6$.

Resource elements (k, l) used for transmission of cell-specific reference signals on any of the antenna ports in a slot shall not be used for any transmission on any other antenna port in the same slot and set to zero.

In an MBSFN subframe, cell-specific reference signals shall only be transmitted in the non-MBSFN region of the MBSFN subframe.

Figures 6.10.1.2-1 and 6.10.1.2-2 illustrate the resource elements used for reference signal transmission according to the above definition. The notation R_p is used to denote a resource element used for reference signal transmission on antenna port p .

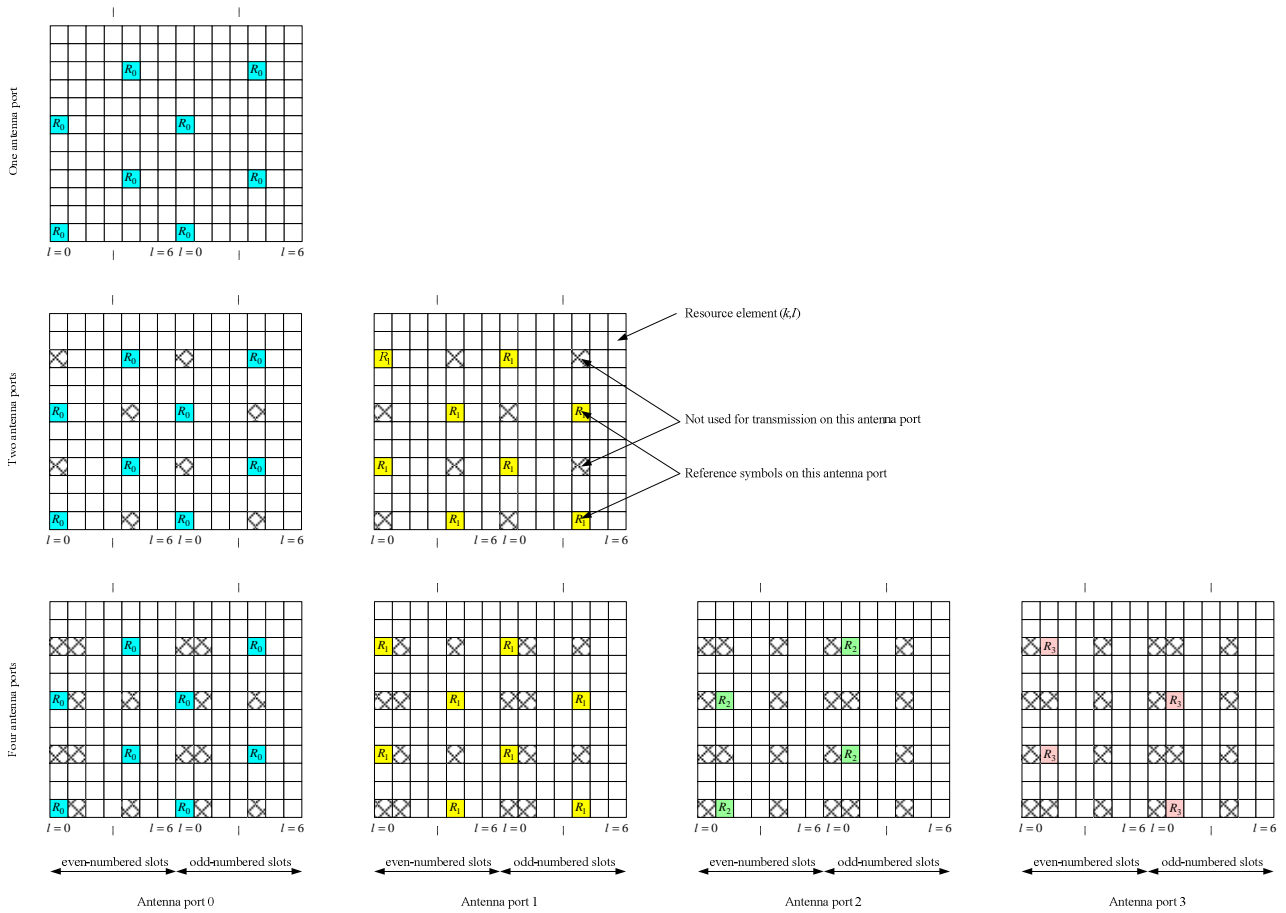

Figure 6.10.1.2-1. Mapping of downlink reference signals (normal cyclic prefix)

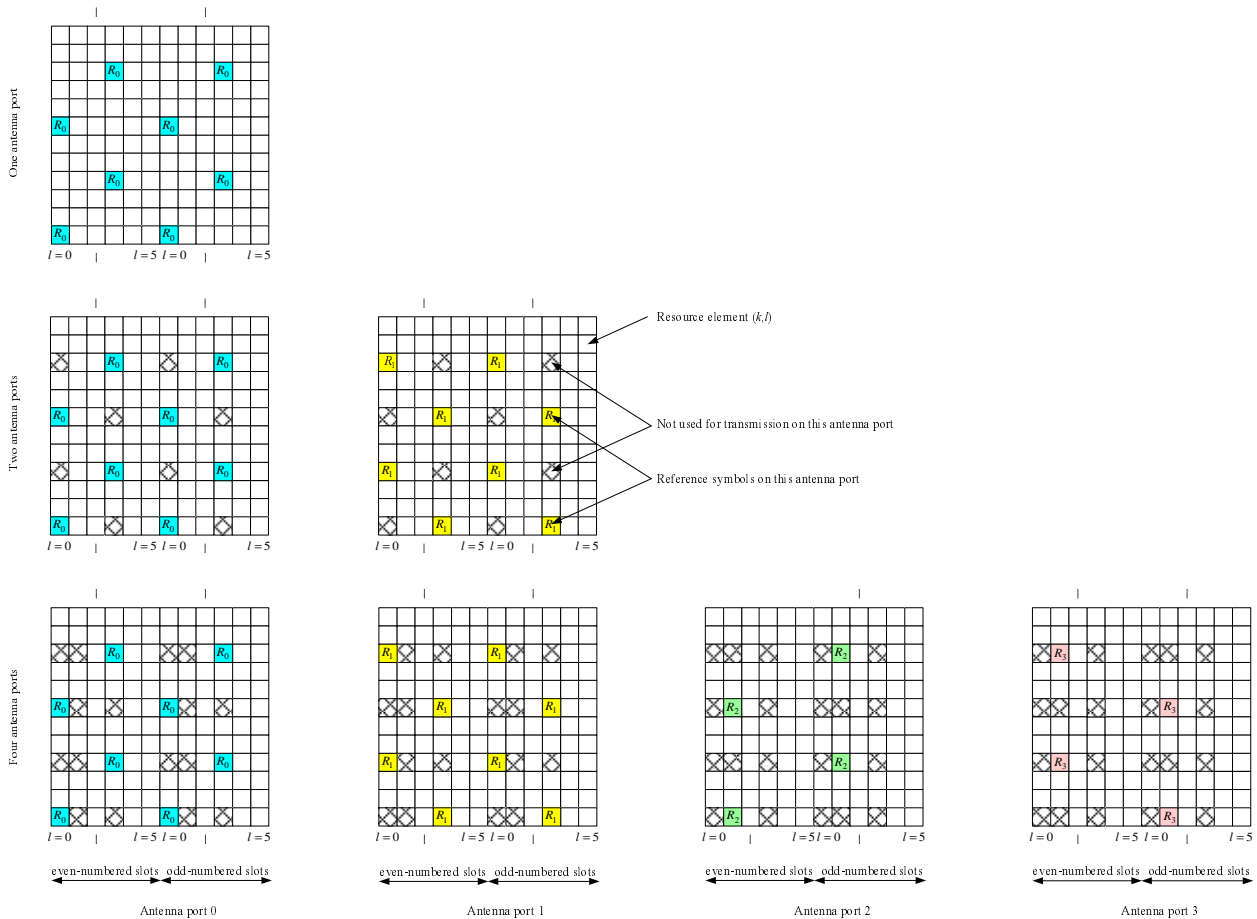

Figure 6.10.1.2-2. Mapping of downlink reference signals (extended cyclic prefix)

6.10.2 MBSFN reference signals

MBSFN reference signals shall be transmitted in the MBSFN region of MBSFN subframes only when the PMCH is transmitted. MBSFN reference signals are transmitted on antenna port 4.

For an MBMS-dedicated carrier configured with a single MBSFN area, and for a PMCH transmitted with 0.37 kHz subcarrier spacing in slot n , which is indicated to contain MCCH by higher layer parameter *MCCH-Config*:

- for MBSFN reference signal pattern type 1, the UE may assume that MBSFN reference signals associated with the same N_{ID}^{MBSFN} are present in the three preceding slots to slot n .
- for MBSFN reference signal pattern type 2, the UE may assume that MBSFN reference signals associated with the same N_{ID}^{MBSFN} are present in the preceding slot to slot n .

MBSFN reference signals are defined for extended cyclic prefix only.

6.10.2.1 Sequence generation

6.10.2.1.1 Sequence generation for 15 kHz and 7.5 kHz subcarrier spacing

The MBSFN reference-signal sequence $r_{l,n_s}(m)$ is defined by

$$r_{l,n_s}(m) = \frac{1}{\sqrt{2}}(1 - 2 \cdot c(2m)) + j \frac{1}{\sqrt{2}}(1 - 2 \cdot c(2m + 1)), \quad m = 0, 1, \dots, 6N_{RB}^{max,DL} - 1$$

where n_s is the slot number within a radio frame and l is the OFDM symbol number within the slot. The pseudo-random sequence $c(i)$ is defined in clause 7.2. The pseudo-random sequence generator shall be initialised with

$c_{\text{init}} = 2^9 \cdot (7 \cdot (n_s + 1) + l + 1) \cdot (2 \cdot N_{\text{ID}}^{\text{MBSFN}} + 1) + N_{\text{ID}}^{\text{MBSFN}}$ at the start of each OFDM symbol.

6.10.2.1.2 Sequence generation for 1.25 kHz subcarrier spacing

The MBSFN reference-signal sequence $r_{l,n_{\text{sf}}}(m)$ is defined by

$$r_{l,n_{\text{sf}}}(m) = \frac{1}{\sqrt{2}}(1 - 2 \cdot c(2m)) + j \frac{1}{\sqrt{2}}(1 - 2 \cdot c(2m + 1)), \quad m = 0, 1, \dots, 24N_{\text{RB}}^{\text{max,DL}} - 1$$

where n_{sf} is the subframe number within a radio frame and l is the OFDM symbol number within the subframe. The pseudo-random sequence $c(i)$ is defined in clause 7.2. The pseudo-random sequence generator shall be initialised with $c_{\text{init}} = 2^9 \cdot (7 \cdot (n_{\text{sf}} + 1) + l + 1) \cdot (2 \cdot N_{\text{ID}}^{\text{MBSFN}} + 1) + N_{\text{ID}}^{\text{MBSFN}}$ at the start of each OFDM symbol.

6.10.2.1.3 Sequence generation for 2.5 kHz subcarrier spacing

The MBSFN reference-signal sequence $r_{l,n_{\text{sf}}}(m)$ is defined by

$$r_{l,n_{\text{sf}}}(m) = \frac{1}{\sqrt{2}}(1 - 2c(2m)) + j \frac{1}{\sqrt{2}}(1 - 2c(2m + 1))$$

$$m = 0, 1, \dots, 18N_{\text{RB}}^{\text{max,DL}} - 1$$

where n_{sf} is the subframe number within a radio frame and l is the OFDM symbol number within the subframe. The pseudo-random sequence $c(i)$ is defined in clause 7.2. The pseudo-random sequence generator shall be initialised with

$$c_{\text{init}} = 2^9(7(n_{\text{sf}} + 1) + l + 1)(2N_{\text{ID}}^{\text{MBSFN}} + 1) + N_{\text{ID}}^{\text{MBSFN}}$$

6.10.2.1.4 Sequence generation for 0.37 kHz subcarrier spacing

The MBSFN reference-signal sequence $r_{l,n_s}(m)$ is defined by

$$r_{l,n_s}(m) = \frac{1}{\sqrt{2}}(1 - 2c(2m)) + j \frac{1}{\sqrt{2}}(1 - 2c(2m + 1))$$

$$m = 0, 1, \dots, \frac{N_{\text{sc}}^{\text{RB}}}{12} N_{\text{RB}}^{\text{max,DL}} - 1 \quad \text{for MBMSFN reference signal pattern type 1}$$

$$m = 0, 1, \dots, \frac{N_{\text{sc}}^{\text{RB}}}{6} N_{\text{RB}}^{\text{max,DL}} - 1 \quad \text{for MBMSFN reference signal pattern type 2}$$

where n_s is the 3 ms slot number within the 40 ms period and l is the OFDM symbol number within the slot. The pseudo-random sequence $c(i)$ is defined in clause 7.2. The pseudo-random sequence generator shall be initialised with

$$c_{\text{init}} = 2^9(7(n_s + 1) + l + 1)(2N_{\text{ID}}^{\text{MBSFN}} + 1) + N_{\text{ID}}^{\text{MBSFN}}$$

6.10.2.2 Mapping to resource elements

6.10.2.2.1 Mapping to resource elements for 15 kHz and 7.5 kHz subcarrier spacing

The reference-signal sequence $r_{l,n_s}(m')$ in OFDM symbol l shall be mapped to complex-valued modulation symbols $a_{k,l}^{(p)}$ with $p = 4$ according to

$$a_{k,l}^{(p)} = r_{l,n_s}(m')$$

where

$$k = \begin{cases} 2m & \text{if } l \neq 0 \text{ and } \Delta f = 15 \text{ kHz} \\ 2m+1 & \text{if } l = 0 \text{ and } \Delta f = 15 \text{ kHz} \\ 4m & \text{if } l \neq 0 \text{ and } \Delta f = 7.5 \text{ kHz} \\ 4m+2 & \text{if } l = 0 \text{ and } \Delta f = 7.5 \text{ kHz} \end{cases}$$

$$l = \begin{cases} 2 & \text{if } n_s \bmod 2 = 0 \text{ and } \Delta f = 15 \text{ kHz} \\ 0,4 & \text{if } n_s \bmod 2 = 1 \text{ and } \Delta f = 15 \text{ kHz} \\ 1 & \text{if } n_s \bmod 2 = 0 \text{ and } \Delta f = 7.5 \text{ kHz} \\ 0,2 & \text{if } n_s \bmod 2 = 1 \text{ and } \Delta f = 7.5 \text{ kHz} \end{cases}$$

$$m = 0,1,\dots,6N_{RB}^{DL} - 1$$

$$m' = m + 3(N_{RB}^{max,DL} - N_{RB}^{DL})$$

Figure 6.10.2.2-1 illustrates the resource elements used for MBSFN reference signal transmission in case of $\Delta f = 15 \text{ kHz}$. In case of $\Delta f = 7.5 \text{ kHz}$, the MBSFN reference signal shall be mapped to resource elements according to Figure 6.10.2.2-3. The notation R_p is used to denote a resource element used for reference signal transmission on antenna port p .

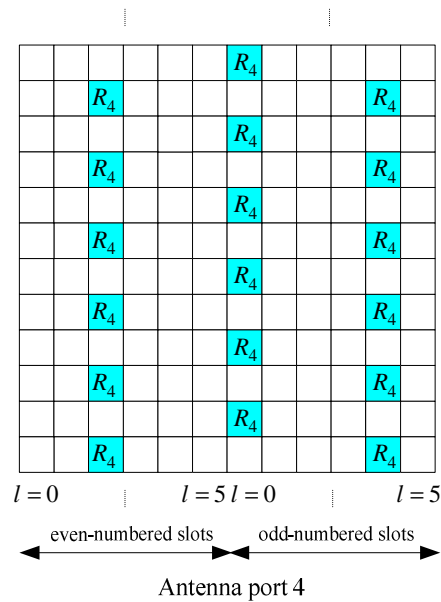

Figure 6.10.2.2-1: Mapping of MBSFN reference signals (extended cyclic prefix, $\Delta f = 15 \text{ kHz}$)

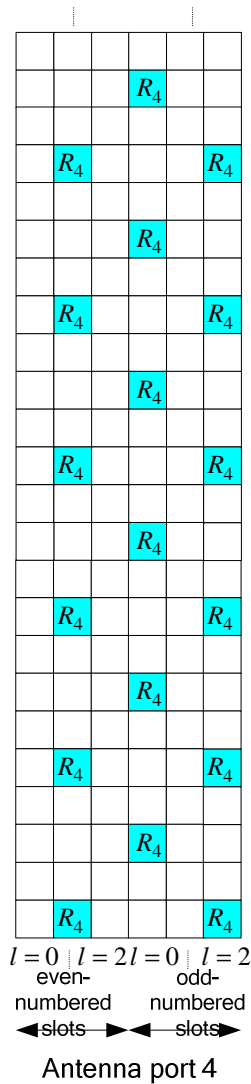

Figure 6.10.2.2-3: Mapping of MBSFN reference signals (extended cyclic prefix, $\Delta f = 7.5$ kHz)

6.10.2.2.2 Mapping to resource elements for 1.25 kHz

The reference-signal sequence $r_{l,n_{sf}}(m')$ in OFDM symbol l shall be mapped to complex-valued modulation symbols $a_{k,l}^{(p)}$ with $p = 4$ according to

$$a_{k,l}^{(p)} = r_{l,n_{sf}}(m')$$

where

$$k = \begin{cases} 6m & \text{if } n_{sf} \bmod 2 = 0 \\ 6m + 3 & \text{if } n_{sf} \bmod 2 = 1 \end{cases}$$

$$l = 0$$

$$m = 0, 1, \dots, 24N_{RB}^{DL} - 1$$

$$m' = m + 3(N_{RB}^{max,DL} - N_{RB}^{DL})$$

6.10.2.2.3 Mapping to resource elements for 2.5 kHz subcarrier spacing

The reference-signal sequence $r_{l,n_{sf}}(m')$ in OFDM symbol l shall be mapped to complex-valued modulation symbols

$a_{k,l}^{(p)}$ with $p = 4$ according to

$$a_{k,l}^{(p)} = r_{l,n_{sf}}(m')$$

where

$$\begin{aligned} k &= \begin{cases} 4m & \text{if } l = 0 \\ 4m + 2 & \text{if } l = 1 \end{cases} \\ l &= 0, 1 \\ m &= 0, 1, \dots, \frac{N_{sc}^{RB}}{4} N_{RB}^{DL} - 1 \\ m' &= m + \frac{N_{sc}^{RB}}{4} \Delta \\ \Delta &= \frac{N_{RB}^{\max,DL} - N_{RB}^{DL}}{2} \end{aligned}$$

6.10.2.2.4 Mapping to resource elements for 0.37 kHz subcarrier spacing

The reference-signal sequence $r_l(m')$ in OFDM symbol l shall be mapped to complex-valued modulation symbols $a_{k,l}^{(p)}$ with $p = 4$ according to

$$a_{k,l}^{(p)} = r_{l,n_s}(m')$$

when

$$0 \leq k < N_{sc}^{RB} N_{RB}^{DL}$$

and where \tilde{n}_s is the 3ms absolute slot number, defined as $\tilde{n}_s = n_s + 13 \lfloor n_f/4 \rfloor$, n_s is the 3 ms slot number as defined in clause 4.1 and

- for MBSFN reference signal pattern type 1

$$\begin{aligned} k &= 12 \left(m' - \left\lfloor \frac{N_{sc}^{RB}}{12} \Delta \right\rfloor \right) + 3(\tilde{n}_s \bmod 4) \\ l &= 0 \\ \Delta &= \frac{N_{RB}^{\max,DL} - N_{RB}^{DL}}{2} \\ m' &= 0, 1, \dots, \frac{N_{sc}^{RB}}{12} N_{RB}^{\max,DL} - 1 \end{aligned}$$

- for MBSFN reference signal pattern type 2

$$\begin{aligned} k &= 6 \left(m' - \left\lfloor \frac{N_{sc}^{RB}}{6} \Delta \right\rfloor \right) + 3(\tilde{n}_s \bmod 2) \\ l &= 0 \\ \Delta &= \frac{N_{RB}^{\max,DL} - N_{RB}^{DL}}{2} \\ m' &= 0, 1, \dots, \frac{N_{sc}^{RB}}{6} N_{RB}^{\max,DL} - 1 \end{aligned}$$

6.10.3 UE-specific reference signals associated with PDSCH

UE-specific reference signals associated with PDSCH

- are transmitted on antenna port(s) $p = 5$, $p = 7$, $p = 8$, $p = 11$, $p = 13$, $p = \{11, 13\}$, $p = 7, 8, \dots, v+6$, or on the antenna ports indicated in Table 6.3.4.4-1, where v is the number of layers used for transmission of the PDSCH;
- are present and are a valid reference for PDSCH demodulation only if the PDSCH transmission is associated with the corresponding antenna port according to clause 7.1 of 3GPP TS 36.213 [4];

- are transmitted only on the physical resource blocks upon which the corresponding PDSCH is mapped.

A UE-specific reference signal associated with PDSCH is not transmitted in resource elements (k, l) in which one of the physical channels or physical signals other than the UE-specific reference signals defined in 6.1 are transmitted using resource elements with the same index pair (k, l) regardless of their antenna port p .

A UE-specific reference signal associated with subslot-PDSCH or slot-PDSCH is only transmitted in physical resource blocks in frequency domain assigned for PDSCH transmission where

- the assignment maps to both physical resource blocks of a given PRG (see clause 6.4.2);
- in case of subslot-PDSCH, the associated SPDCCH is not mapped to resource elements of a given PRG assigned for PDSCH transmission (see clause 6.4.2)..

For frame structure type 3, for PDSCH in a subframe with the same duration as the DwPTS duration of a special subframe configuration, the UE-specific reference signals are defined the same as that for the corresponding special subframe configuration.

6.10.3.1 Sequence generation

For antenna port 5, the UE-specific reference-signal sequence $r_{n_s}(m)$ is defined by

$$r_{n_s}(m) = \frac{1}{\sqrt{2}}(1 - 2 \cdot c(2m)) + j \frac{1}{\sqrt{2}}(1 - 2 \cdot c(2m+1)), \quad m = 0, 1, \dots, 12N_{\text{RB}}^{\text{PDSCH}} - 1$$

where $N_{\text{RB}}^{\text{PDSCH}}$ denotes the assigned bandwidth in resource blocks of the corresponding PDSCH transmission. The pseudo-random sequence $c(i)$ is defined in clause 7.2. The pseudo-random sequence generator shall be initialised with $c_{\text{init}} = (\lfloor n_s/2 \rfloor + 1) \cdot (2N_{\text{ID}}^{\text{cell}} + 1) \cdot 2^{16} + n_{\text{RNTI}}$ at the start of each subframe where n_{RNTI} is as described in clause 7.1 3GPP TS 36.213 [4].

For any of the antenna ports $p \in \{7, 8, \dots, 14\}$, the reference-signal sequence $r(m)$ is defined by

$$r(m) = \frac{1}{\sqrt{2}}(1 - 2 \cdot c(2m)) + j \frac{1}{\sqrt{2}}(1 - 2 \cdot c(2m+1)), \quad m = \begin{cases} 0, 1, \dots, 12N_{\text{RB}}^{\text{max,DL}} - 1 & \text{normal cyclic prefix} \\ 0, 1, \dots, 16N_{\text{RB}}^{\text{max,DL}} - 1 & \text{extended cyclic prefix} \end{cases}$$

The pseudo-random sequence $c(i)$ is defined in clause 7.2. The pseudo-random sequence generator shall be initialised with

$$c_{\text{init}} = (\lfloor n_s/2 \rfloor + 1) \cdot (2n_{\text{ID}}^{(\text{SCID})} + 1) \cdot 2^{16} + n_{\text{SCID}}$$

at the start of each subframe.

For BL/CE UEs, the same scrambling sequence is applied per subframe to the UE-specific reference-signal sequence for a given block of N_{acc} subframes. The subframe number of the first subframe in each block of N_{acc} consecutive subframes, denoted as $n_{\text{abs},1}$, satisfies $(n_{\text{abs},1} + i_{\Delta}) \bmod N_{\text{acc}} = 0$. For the j^{th} block of N_{acc} subframes, the scrambling sequence generator shall be initialised with

$$c_{\text{init}} = (\lfloor (j_0 + j)N_{\text{acc}} \bmod 10 \rfloor + 1) \cdot (2N_{\text{ID}}^{\text{cell}} + 1) \cdot 2^{16} + n_{\text{SCID}}$$

where

$$j = 0, 1, \dots, \left\lfloor \frac{i_0 + N_{\text{abs}}^{\text{PDSCH}} + i_{\Delta} - 1}{N_{\text{acc}}} \right\rfloor - j_0$$

$$j_0 = \lfloor (i_0 + i_{\Delta}) / N_{\text{acc}} \rfloor$$

$$i_{\Delta} = \begin{cases} 0, & \text{for frame structure type 1 or } N_{\text{acc}} = 1 \\ N_{\text{acc}} - 2, & \text{for frame structure type 2 and } N_{\text{acc}} = 10 \end{cases}$$

and i_0 is the absolute subframe number of the first downlink subframe intended for PDSCH. The PDSCH transmissions span $N_{\text{abs}}^{\text{PDSCH}}$ consecutive subframes, including subframes that are not BL/CE DL subframes where the PDSCH transmission is postponed. For a BL/CE UE configured in CEModeA, $N_{\text{acc}} = 1$. For a BL/CE UE configured with CEModeB, $N_{\text{acc}} = 4$ for frame structure type 1 and $N_{\text{acc}} = 10$ for frame structure type 2.

The quantities $n_{\text{ID}}^{(i)}$, $i = 0,1$, are given by

- $n_{\text{ID}}^{(i)} = N_{\text{ID}}^{\text{cell}}$ if no value for $n_{\text{ID}}^{\text{DMRS},j}$ is provided by higher layers or if DCI format 1A, 2B or 2C is used for the DCI associated with the PDSCH transmission
- $n_{\text{ID}}^{(i)} = n_{\text{ID}}^{\text{DMRS},j}$ otherwise

The value of n_{SCID} is zero unless specified otherwise. For a PDSCH transmission on ports 7 or 8, n_{SCID} is given by the DCI format 2B, 2C, 2D, 6-1A, 7-1E, 7-1F and 7-1G in 3GPP TS 36.212 [3] associated with the PDSCH transmission. In the case of DCI format 2B or 7-1E, n_{SCID} is indicated by the scrambling identity field according to Table 6.10.3.1-1. In the case of DCI format 2C or 2D, n_{SCID} is given by Table 5.3.3.1.5C-1, Table 5.3.3.1.5C-2 or Table 5.3.3.1.5C-6 in 3GPP TS 36.212 [3]. In the case of DCI format 7-1F or 7-1G, n_{SCID} is given by Table 5.3.3.1.22-1, Table 5.3.3.1.22-2, Table 5.3.3.1.22-3 or Table 5.3.3.1.5C-6 in 3GPP TS 36.212 [3]. For a PDSCH transmission on ports 11 or 13, n_{SCID} is given by the DCI format 2C or 2D in 3GPP TS 36.212 [3] associated with the PDSCH transmission where n_{SCID} is given by Table 5.3.3.1.5C-2 in 3GPP TS 36.212 [3].

Table 6.10.3.1-1: Mapping of scrambling identity field in DCI format 2B to n_{SCID} values for antenna ports 7 and 8

Scrambling identity field in DCI format 2B (3GPP TS 36.212 [3])	n_{SCID}
0	0
1	1

6.10.3.2 Mapping to resource elements

For antenna port 5, in a physical resource block with frequency-domain index n_{PRB} assigned for the corresponding PDSCH transmission, the reference signal sequence $r_{n_s}(m)$ shall be mapped to complex-valued modulation symbols $a_{k,l}^{(p)}$ with $p = 5$ in a subframe according to:

Normal cyclic prefix:

$$a_{k,l}^{(p)} = r_{n_s}(3 \cdot l' \cdot N_{\text{RB}}^{\text{PDSCH}} + m')$$

$$k = (k') \bmod N_{\text{sc}}^{\text{RB}} + N_{\text{sc}}^{\text{RB}} \cdot n_{\text{PRB}}$$

$$k' = \begin{cases} 4m' + v_{\text{shift}} & \text{if } l \in \{2,3\} \\ 4m' + (2 + v_{\text{shift}}) \bmod 4 & \text{if } l \in \{5,6\} \end{cases}$$

$$l = \begin{cases} 3 & l' = 0 \\ 6 & l' = 1 \\ 2 & l' = 2 \\ 5 & l' = 3 \end{cases}$$

$$l' = \begin{cases} 0,1 & \text{if } n_s \bmod 2 = 0 \\ 2,3 & \text{if } n_s \bmod 2 = 1 \end{cases}$$

$$m' = 0,1,\dots,3N_{\text{RB}}^{\text{PDSCH}} - 1$$

Extended cyclic prefix:

$$a_{k,l}^{(p)} = r_{n_s} (4 \cdot l' \cdot N_{RB}^{PDSCH} + m')$$

$$k = (k') \bmod N_{sc}^{RB} + N_{sc}^{RB} \cdot n_{PRB}$$

$$k' = \begin{cases} 3m' + v_{\text{shift}} & \text{if } l = 4 \\ 3m' + (2 + v_{\text{shift}}) \bmod 3 & \text{if } l = 1 \end{cases}$$

$$l = \begin{cases} 4 & l' \in \{0, 2\} \\ 1 & l' = 1 \end{cases}$$

$$l' = \begin{cases} 0 & \text{if } n_s \bmod 2 = 0 \\ 1, 2 & \text{if } n_s \bmod 2 = 1 \end{cases}$$

$$m' = 0, 1, \dots, 4N_{RB}^{PDSCH} - 1$$

where m' is the counter of UE-specific reference signal resource elements within a respective OFDM symbol of the PDSCH transmission.

The cell-specific frequency shift is given by $v_{\text{shift}} = N_{ID}^{\text{cell}} \bmod 3$.

The mapping shall be in increasing order of the frequency-domain index n_{PRB} of the physical resource blocks assigned for the corresponding PDSCH transmission. The quantity N_{RB}^{PDSCH} denotes the assigned bandwidth in resource blocks of the corresponding PDSCH transmission.

Figure 6.10.3.2-1 illustrates the resource elements used for UE-specific reference signals for normal cyclic prefix for antenna port 5.

Figure 6.10.3.2-2 illustrates the resource elements used for UE-specific reference signals for extended cyclic prefix for antenna port 5.

The notation R_p is used to denote a resource element used for reference signal transmission on antenna port p .

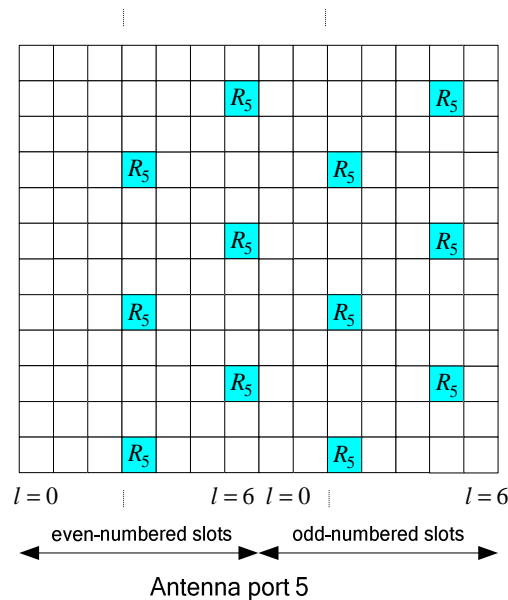

Figure 6.10.3.2-1: Mapping of UE-specific reference signals, antenna port 5 (normal cyclic prefix)

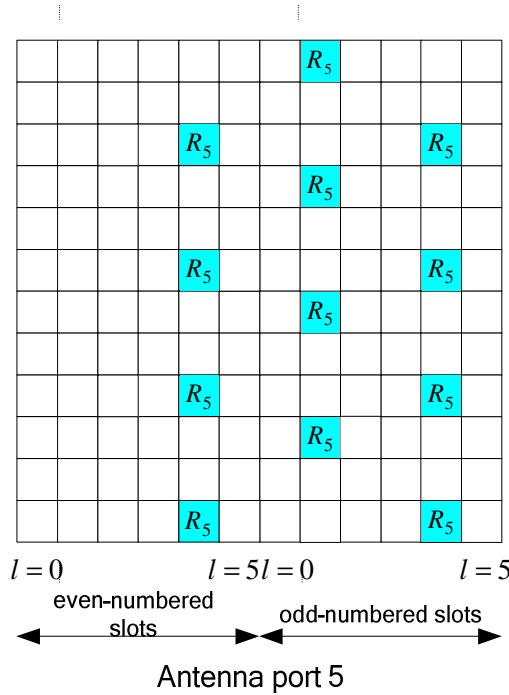

Figure 6.10.3.2-2: Mapping of UE-specific reference signals, antenna port 5 (extended cyclic prefix)

For antenna ports $p = 7, p = 8, p = 11, p = 13, p = \{11, 13\}, p = 7, 8, \dots, \nu + 6$, or the antenna ports indicated in Table 6.3.4.4-1 in a physical resource block with frequency-domain index n_{PRB} assigned for the corresponding PDSCH transmission, a part of the reference signal sequence $r(m)$ shall be mapped to complex-valued modulation symbols $a_{k,l}^{(p)}$ in a subframe according to

Normal cyclic prefix:

$$a_{k,l}^{(p)} = w_p(l') \cdot r(3 \cdot l' \cdot N_{\text{RB}}^{\text{max,DL}} + 3 \cdot n_{\text{PRB}} + m')$$

where

$$w_p(i) = \begin{cases} \bar{w}_p(i) & (m' + n_{\text{PRB}}) \bmod 2 = 0 \\ \bar{w}_p(3 - i) & (m' + n_{\text{PRB}}) \bmod 2 = 1 \end{cases}$$

$$k = 5m' + N_{\text{sc}}^{\text{RB}} n_{\text{PRB}} + k'$$

$$k' = \begin{cases} 1 & p \in \{7, 8, 11, 13\} \\ 0 & p \in \{9, 10, 12, 14\} \end{cases}$$

$$l = \begin{cases} l' \bmod 2 + 2 & \text{if in a special subframe with configuration 3, 4, 8, 9 or 10 (see Table 4.2 - 1)} \\ l' \bmod 2 + 2 + 3 \lfloor l' / 2 \rfloor & \text{if in a special subframe with configuration 1, 2, 6, or 7 (see Table 4.2 - 1)} \\ l' \bmod 2 + 5 & \text{if not in a special subframe} \end{cases}$$

$$l' = \begin{cases} 0, 1, 2, 3 & \text{if } n_s \bmod 2 = 0 \text{ and in a special subframe with configuration 1, 2, 6, or 7 (see Table 4.2 - 1)} \\ 0, 1 & \text{if } n_s \bmod 2 = 0 \text{ and not in special subframe with configuration 1, 2, 6, or 7 (see Table 4.2 - 1)} \\ 2, 3 & \text{if } n_s \bmod 2 = 1 \text{ and not in special subframe with configuration 1, 2, 6, or 7 (see Table 4.2 - 1)} \end{cases}$$

$$m' = 0, 1, 2$$

The sequence $\bar{w}_p(i)$ is given by Table 6.10.3.2-1.

Table 6.10.3.2-1: The sequence $\bar{w}_p(i)$ for normal cyclic prefix

Antenna port p	$[\bar{w}_p(0) \ \bar{w}_p(1) \ \bar{w}_p(2) \ \bar{w}_p(3)]$
7	[+1 +1 +1 +1]
8	[+1 -1 +1 -1]
9	[+1 +1 +1 +1]
10	[+1 -1 +1 -1]
11	[+1 +1 -1 -1]
12	[-1 -1 +1 +1]
13	[+1 -1 -1 +1]
14	[-1 +1 +1 -1]

Extended cyclic prefix:

$$a_{k,l}^{(p)} = w_p(l' \bmod 2) \cdot r(4 \cdot l' \cdot N_{\text{RB}}^{\text{max,DL}} + 4 \cdot n_{\text{PRB}} + m')$$

where

$$w_p(i) = \begin{cases} \bar{w}_p(i) & m' \bmod 2 = 0 \\ \bar{w}_p(1-i) & m' \bmod 2 = 1 \end{cases}$$

$$k = 3m' + N_{\text{sc}}^{\text{RB}} n_{\text{PRB}} + k'$$

$$k' = \begin{cases} 1 & \text{if } n_s \bmod 2 = 0 \text{ and } p \in \{7,8\} \\ 2 & \text{if } n_s \bmod 2 = 1 \text{ and } p \in \{7,8\} \end{cases}$$

$$l = l' \bmod 2 + 4$$

$$l' = \begin{cases} 0,1 & \text{if } n_s \bmod 2 = 0 \text{ and in a special subframe with configuration 1, 2, 3, 5 or 6 (see Table 4.2 - 1)} \\ 0,1 & \text{if } n_s \bmod 2 = 0 \text{ and not in a special subframe} \\ 2,3 & \text{if } n_s \bmod 2 = 1 \text{ and not in a special subframe} \end{cases}$$

$$m' = 0,1,2,3$$

The sequence $\bar{w}_p(i)$ is given by Table 6.10.3.2-2.

Table 6.10.3.2-2: The sequence $\bar{w}_p(i)$ for extended cyclic prefix and for slot/subslot-PDSCH

Antenna port p	$[\bar{w}_p(0) \ \bar{w}_p(1)]$
7	[+1 +1]
8	[-1 +1]
9	[+1 +1]
10	[-1 +1]

For extended cyclic prefix, UE-specific reference signals are not supported on antenna ports 9 to 14.

For slot-PDSCH transmission, the baseline pattern (see ‘Baseline’ in Figure 6.10.3.2-2A) of UE-specific reference signals is defined as follows. It is applied in MBSFN subframes.

$$a_{k,l}^{(p)} = w_p(l') \cdot r(3 \cdot l' \cdot N_{\text{RB}}^{\text{max,DL}} + 3 \cdot n_{\text{PRB}} + m')$$

where

- $w_p(i) = \begin{cases} \bar{w}_p(i) & m' \bmod 2 = 0 \\ \bar{w}_p(1-i) & m' \bmod 2 = 1 \end{cases}$
- $m' = 0,1,2$
- $l' = 0,1$

- $l = l_0 + l'$
- $k' = \begin{cases} 1 & p \in \{7,8\} \\ 0 & p \in \{9,10\} \end{cases}$
- $k = 5m' + N_{sc}^{RB} n_{PRB} + k'$

and

- $l_0 = 3$ if the slot where the PDSCH is transmitted in (n_s) fulfils $n_s \bmod 2 = 0$
- $l_0 = 2$ if the slot where the PDSCH is transmitted in (n_s) fulfils $n_s \bmod 2 = 1$

The sequence $\bar{w}_p(i)$ is given by Table 6.10.3.2-2.

For slot-PDSCH transmission in normal subframes, $a_{k,l}^{(p)}$ is generated as for the baseline slot-PDSCH UE-specific reference signal pattern for the same values of l , while k is given by $k = N_{sc}^{RB} n_{PRB} + k'$ and depends on the cell-specific frequency shift v_{shift} as follows (see ‘v0’, ‘v1’ and ‘v2’ in Figure 6.10.3.2-2A for $v_{\text{shift}} \bmod 3 = 0$, $v_{\text{shift}} \bmod 3 = 1$, and $v_{\text{shift}} \bmod 3 = 2$, respectively):

- For $v_{\text{shift}} \bmod 3 = 0$, $k' = \begin{cases} 2, 7, 11 & p \in \{7,8\} \\ 1, 5, 10 & p \in \{9,10\} \end{cases}$
- For $v_{\text{shift}} \bmod 3 = 1$, $k' = \begin{cases} 2, 6, 11 & p \in \{7,8\} \\ 0, 5, 9 & p \in \{9,10\} \end{cases}$
- For $v_{\text{shift}} \bmod 3 = 2$, $k' = \begin{cases} 1, 6, 10 & p \in \{7,8\} \\ 0, 4, 9 & p \in \{9,10\} \end{cases}$

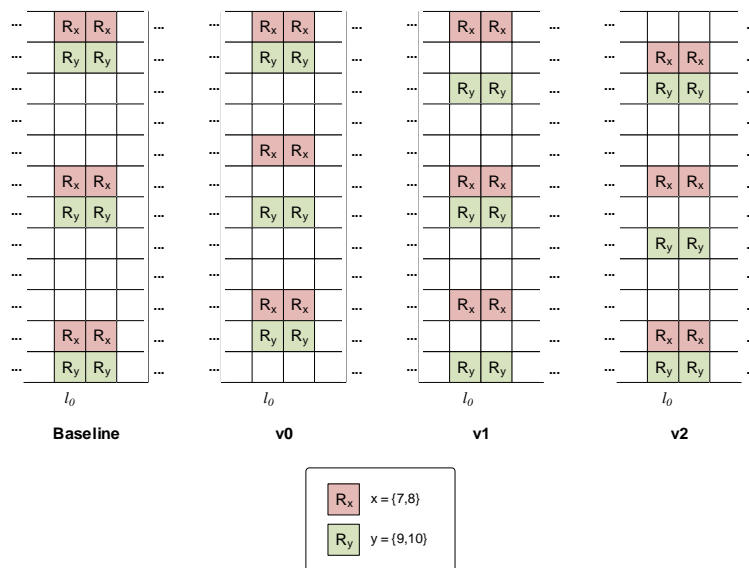

Figure 6.10.3.2-2A: Mapping of UE-specific reference signals for slot-PDSCH, antenna ports 7, 8, 9 and 10 (normal cyclic prefix)

For subslot-PDSCH transmission, the baseline pattern (see ‘Baseline’ in Figure 6.10.3.2-2B) of UE-specific reference signals is defined as follows. It is applied if the presence of UE-specific reference signals is indicated in the DCI associated with the subslot-PDSCH (see *DMRS position indicator* field in 3GPP TS 36.212 [3]), and in downlink subslots where the baseline pattern, including all the REs associated with $p \in \{7,8\}$ if the parameter *maxLayersMIMO-STTI* is configured with 2 layers, or $p \in \{7,8,9,10\}$ if the parameter *maxLayersMIMO-STTI* is configured with 4 layers, has no overlapping resource element with CRS and no overlapping resource element with configured zero-power and non-zero-power CSI reference signals:

$$a_{k,l}^{(p)} = w_p(l') \cdot r(2 \cdot l' \cdot N_{\text{RB}}^{\text{max,DL}} + 2 \cdot n_{\text{PRB}} + m')$$

where

$$w_p(i) = \begin{cases} \bar{w}_p(i) & m' \bmod 2 = 0 \\ \bar{w}_p(1-i) & m' \bmod 2 = 1 \end{cases}$$

$$k = 7m' + N_{\text{sc}}^{\text{RB}} n_{\text{PRB}} + k' + 2 \cdot (n_{\text{PRB}} \bmod 2)$$

$$k' = \begin{cases} 1 & p \in \{7,8\} \\ 0 & p \in \{9,10\} \end{cases}$$

$$l = l' + l_0 \text{ (see Table 6.4.2-1)}$$

$$l' = 0,1$$

$$m' = 0,1$$

The sequence $\bar{w}_p(i)$ is given by Table 6.10.3.2-2. For subslot-PDSCH transmission in normal subframes, in downlink subslots where the baseline pattern, including all the REs associated with $p \in \{7,8\}$ if the parameter *maxLayersMIMO-STTI* is configured with 2 layers, or $p \in \{7,8,9,10\}$ if the parameter *maxLayersMIMO-STTI* is configured with 4 layers, has overlapping resource elements with configured zero-power or non-zero-power CSI reference signals or has overlapping resource elements with CRS, if the presence of UE-specific reference signals is indicated in the DCI associated (see *DMRS position indicator* field in 3GPP TS 36.212 [3]) with the subslot-PDSCH, a shifted pattern of UE-specific reference signals is applied. In the shifted pattern, $a_{k,l}^{(p)}$ is generated as for the baseline subslot-PDSCH UE-specific reference signal pattern for the same value of l , while k is given by $k = N_{\text{sc}}^{\text{RB}} n_{\text{PRB}} + k'$ and depends on the cell-specific frequency shift v_{shift} as follows (see also ‘v0’, ‘v1’ and ‘v2’ in Figure 6.10.3.2-2B for $v_{\text{shift}} \bmod 3 = 0$, $v_{\text{shift}} \bmod 3 = 1$, and $v_{\text{shift}} \bmod 3 = 2$, respectively):

$$\begin{aligned} \text{- For } v_{\text{shift}} \bmod 3 = 0, k' &= \begin{cases} 2, 8 & p \in \{7, 8\} \text{ and } n_{\text{PRB}} \bmod 2 = 0 \\ 4, 11 & p \in \{7, 8\} \text{ and } n_{\text{PRB}} \bmod 2 = 1 \\ 1, 7 & p \in \{9, 10\} \text{ and } n_{\text{PRB}} \bmod 2 = 0 \\ 2, 10 & p \in \{9, 10\} \text{ and } n_{\text{PRB}} \bmod 2 = 1 \end{cases} \\ \text{- For } v_{\text{shift}} \bmod 3 = 1, k' &= \begin{cases} 2, 8 & p \in \{7, 8\} \text{ and } n_{\text{PRB}} \bmod 2 = 0 \\ 3, 11 & p \in \{7, 8\} \text{ and } n_{\text{PRB}} \bmod 2 = 1 \\ 0, 6 & p \in \{9, 10\} \text{ and } n_{\text{PRB}} \bmod 2 = 0 \\ 2, 9 & p \in \{9, 10\} \text{ and } n_{\text{PRB}} \bmod 2 = 1 \end{cases} \\ \text{- For } v_{\text{shift}} \bmod 3 = 2, k' &= \begin{cases} 1, 9 & p \in \{7, 8\} \text{ and } n_{\text{PRB}} \bmod 2 = 0 \\ 3, 10 & p \in \{7, 8\} \text{ and } n_{\text{PRB}} \bmod 2 = 1 \\ 0, 7 & p \in \{9, 10\} \text{ and } n_{\text{PRB}} \bmod 2 = 0 \\ 1, 9 & p \in \{9, 10\} \text{ and } n_{\text{PRB}} \bmod 2 = 1 \end{cases} \end{aligned}$$

For subslot-PDSCH transmission in MBSFN subframes, in downlink subslots where the baseline pattern, including all the REs associated with $p \in \{7,8\}$ if the parameter *maxLayersMIMO-STTI* is configured with 2 layers, or $p \in \{7,8,9,10\}$ if the parameter *maxLayersMIMO-STTI* is configured with 4 layers, has overlapping resource elements with configured zero-power or non-zero-power CSI reference signals, if the presence of UE-specific reference signals is indicated in the DCI associated (see *DMRS position indicator* field in 3GPP TS 36.212 [3]) with the subslot-PDSCH, the shifted pattern of UE-specific reference signals for $v_{\text{shift}} = 0$, as defined above, is applied (see ‘v0’ in Figure 6.10.3.2-2B for $v_{\text{shift}} \bmod 3 = 0$).

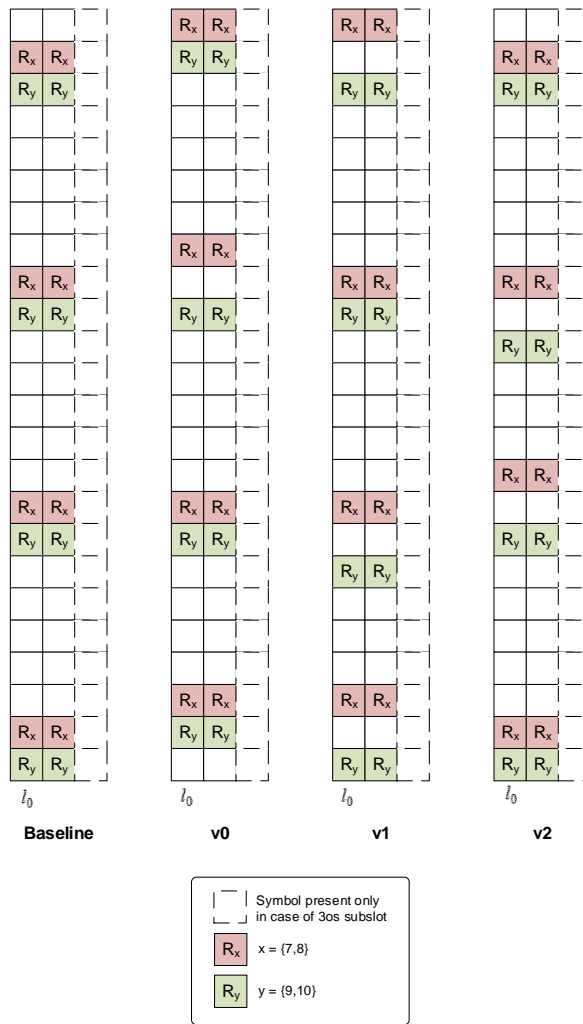

Figure 6.10.3.2-2B: Mapping of UE-specific reference signals for subslot-PDSCH, antenna ports 7, 8, 9 and 10 (normal cyclic prefix)

Resource elements (k, l) used for transmission of UE-specific reference signals to one UE on any of the antenna ports in the set S , where $S = \{7,8,11,13\}$ or $S = \{9,10,12,14\}$ shall

- not be used for transmission of PDSCH on any antenna port in the same slot, and
- not be used for UE-specific reference signals to the same UE on any antenna port other than those in S in the same slot.

Figure 6.10.3.2-3 illustrates the resource elements used for UE-specific reference signals for normal cyclic prefix for antenna ports 7, 8, 9 and 10. Figure 6.10.3.2-4 illustrates the resource elements used for UE-specific reference signals for extended cyclic prefix for antenna ports 7, 8.

For BL/CE UEs, if higher layer parameter *resourceReservationDedicatedDL* is configured, and the Resource reservation field in the DCI is set to 1, then in case of PDSCH transmission associated with C-RNTI or SPS C-RNTI using UE-specific MPDCCH search space including PDSCH transmission without a corresponding MPDCCH,

- If all OFDM symbols in a PRB are reserved, the demodulation reference signal transmission in that PRB is dropped.

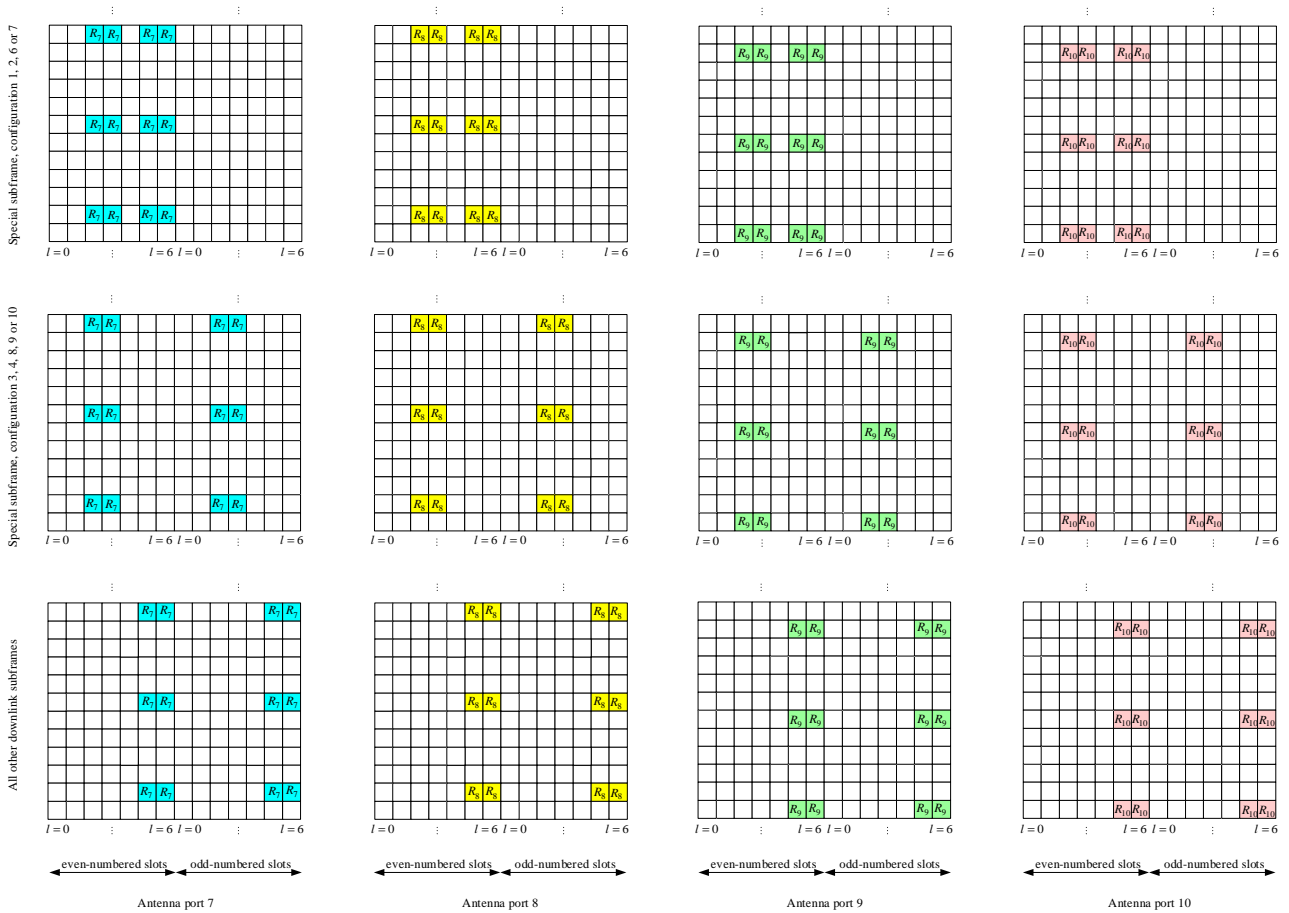

Figure 6.10.3.2-3: Mapping of UE-specific reference signals, antenna ports 7, 8, 9 and 10 (normal cyclic prefix)

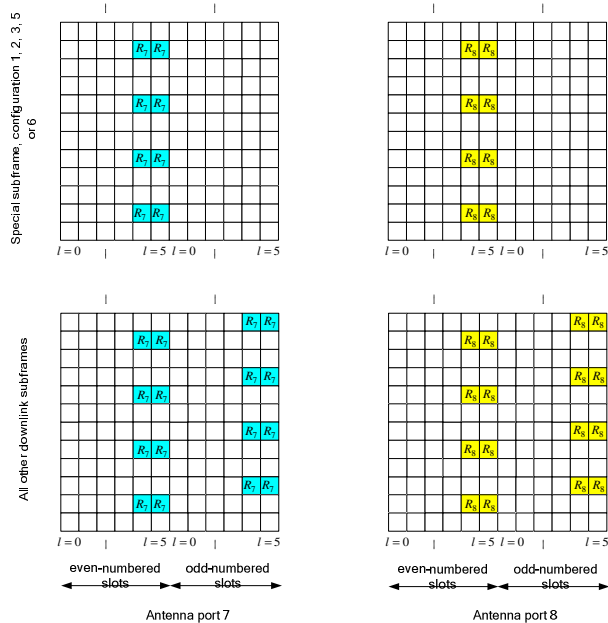

Figure 6.10.3.2-4: Mapping of UE-specific reference signals, antenna ports 7 and 8 (extended cyclic prefix)

6.10.3A Demodulation reference signals associated with EPDCCH, MPDCCH, or SPDCCH

The demodulation reference signal associated with EPDCCH/MPDCCH/SPDCCH

- is transmitted on the same antenna port $p \in \{107,108,109,110\}$ as the associated EPDCCH/MPDCCH/SPDCCH physical resource;
- is present and is a valid reference for EPDCCH/MPDCCH/SPDCCH demodulation only if the EPDCCH/MPDCCH/SPDCCH transmission is associated with the corresponding antenna port;
- is transmitted only on the physical resource blocks upon which the corresponding EPDCCH/MPDCCH/SPDCCH is mapped.

A demodulation reference signal associated with EPDCCH/MPDCCH/SPDCCH is not transmitted in resource elements (k, l) in which one of the physical channels or physical signals other than the demodulation reference signals defined in 6.1 are transmitted using resource elements with the same index pair (k, l) regardless of their antenna port p .

6.10.3A.1 Sequence generation

For any of the antenna ports $p \in \{107,108,109,110\}$, the reference-signal sequence $r(m)$ is defined by

$$r(m) = \frac{1}{\sqrt{2}}(1 - 2 \cdot c(2m)) + j \frac{1}{\sqrt{2}}(1 - 2 \cdot c(2m+1)), \quad m = \begin{cases} 0, 1, \dots, 12N_{\text{RB}}^{\text{max,DL}} - 1 & \text{normal cyclic prefix} \\ 0, 1, \dots, 16N_{\text{RB}}^{\text{max,DL}} - 1 & \text{extended cyclic prefix} \end{cases}$$

For non-BL/CE UEs, the pseudo-random sequence $c(n)$ is defined in clause 7.2. The pseudo-random sequence generator shall be initialised with

$$c_{\text{init}} = (\lfloor n_s / 2 \rfloor + 1) \cdot (2n_{\text{ID},i}^{\text{xPDCCH}} + 1) \cdot 2^{16} + n_{\text{SCID}}^{\text{xPDCCH}}$$

at the start of each subframe where

- $n_{\text{ID},i}^{\text{xPDCCH}}$ and $n_{\text{SCID}}^{\text{xPDCCH}}$ shall be replaced by $n_{\text{ID},i}^{\text{EPDCCH}}$ and $n_{\text{SCID}}^{\text{EPDCCH}}$, respectively, for the EPDCCH
- $n_{\text{ID},i}^{\text{xPDCCH}}$ and $n_{\text{SCID}}^{\text{xPDCCH}}$ shall be replaced by $n_{\text{ID},i}^{\text{SPDCCH}}$ and $n_{\text{SCID}}^{\text{SPDCCH}}$, respectively, for the SPDCCH
- $n_{\text{SCID}}^{\text{EPDCCH}} = 2$, $n_{\text{SCID}}^{\text{SPDCCH}} = 2$, and
- $n_{\text{ID},i}^{\text{EPDCCH}}$ is configured by higher layers.

The EPDCCH/SPDCCH set to which the EPDCCH/SPDCCH associated with the demodulation reference signal belong is denoted $i \in \{0,1\}$.

For BL/CE UEs, the same scrambling sequence is applied per subframe to the demodulation reference signal associated with MPDCCH for a given block of N_{acc} subframes. The subframe number of the first subframe in each block of N_{acc} consecutive subframes, denoted as $n_{\text{abs},1}$, satisfies $(n_{\text{abs},1} + i_{\Delta}) \bmod N_{\text{acc}} = 0$. For the j^{th} block of N_{acc} subframes, the scrambling sequence generator shall be initialised with

$$c_{\text{init}} = \begin{cases} (\lfloor (j_0 + j)N_{\text{acc}} \bmod 10 \rfloor + 1) \cdot (2n_{\text{ID},i}^{\text{MPDCCH}} + 1) \cdot 2^{16} + n_{\text{SCID}}^{\text{MPDCCH}} & \text{otherwise} \\ (\lfloor (j_0 + j)N_{\text{acc}} \bmod 10 \rfloor + 1) \cdot (2N_{\text{ID}}^{\text{cell}} + 1) \cdot 2^{16} + n_{\text{SCID}}^{\text{MPDCCH}} & \text{for Type 1-Common and Type 2-Common} \end{cases} \quad \text{where}$$

$$j = 0, 1, \dots, \left\lfloor \frac{i_0 + N_{\text{abs}}^{\text{MPDCCH}} + i_{\Delta} - 1}{N_{\text{acc}}} \right\rfloor - j_0$$

$$j_0 = \lfloor (i_0 + i_{\Delta}) / N_{\text{acc}} \rfloor$$

$$i_{\Delta} = \begin{cases} 0, & \text{for frame structure type 1 or } N_{\text{acc}} = 1 \\ N_{\text{acc}} - 2, & \text{for frame structure type 2 and } N_{\text{acc}} = 10 \end{cases}$$

and i_0 is the absolute subframe number of the first downlink subframe intended for MPDCCH. The MPDCCH

transmissions span $N_{\text{abs}}^{\text{MPDCCH}}$ consecutive subframes, including subframes that are not BL/CE DL subframes where the MPDCCH transmission is postponed.

For BL/CE UEs,

- if the MPDCCH transmission is associated with P-RNTI or SC-RNTI:
 - $N_{\text{acc}} = 4$ for frame structure type 1 and $N_{\text{acc}} = 10$ for frame structure type 2
- otherwise
 - $N_{\text{acc}} = 1$ for UEs assuming CEModeA (according to the definition in Clause 12 of [4]) or configured with CEModeA.
 - $N_{\text{acc}} = 4$ for frame structure type 1 and $N_{\text{acc}} = 10$ for frame structure type 2 for UEs assuming CEModeB (according to the definition in Clause 12 of [4]) or configured with CEModeB.

The quantities $n_{\text{SCID}}^{\text{MPDCCH}} = 2$ and $n_{\text{ID},i}^{\text{MPDCCH}}$ are configured by higher layers. The MPDCCH set to which the MPDCCH associated with the demodulation reference signal belong is denoted $i \in \{0,1\}$. For an MPDCCH associated with a 2+4 PRB set as defined in [4], $i = 0$ is used to generate the scrambling sequence for the 6 PRBs as well as for the 2 PRBs and 4 PRBs.

6.10.3A.2 Mapping to resource elements

For the antenna port $p \in \{107,108,109,110\}$ in a physical resource block n_{PRB} assigned for the associated EPDCCH/MPDCCH, a part of the reference signal sequence $r(m)$ shall be mapped to complex-valued modulation symbols $a_{k,l}^{(p)}$ in a subframe according to

Normal cyclic prefix:

$$a_{k,l}^{(p)} = w_p(l') \cdot r(3 \cdot l' \cdot N_{\text{RB}}^{\text{max,DL}} + 3 \cdot n_{\text{PRB}} + m')$$

where

$$w_p(i) = \begin{cases} \bar{w}_p(i) & (m' + n_{\text{PRB}}) \bmod 2 = 0 \\ \bar{w}_p(3-i) & (m' + n_{\text{PRB}}) \bmod 2 = 1 \end{cases}$$

$$k = 5m' + N_{\text{sc}}^{\text{RB}} n_{\text{PRB}} + k'$$

$$k' = \begin{cases} 1 & p \in \{107,108\} \\ 0 & p \in \{109,110\} \end{cases}$$

$$l = \begin{cases} l' \bmod 2 + 2 & \text{if in a special subframe with configuration 3, 4, 8, 9 or 10 (see Table 4.2 - 1)} \\ l' \bmod 2 + 2 + 3 \lfloor l'/2 \rfloor & \text{if in a special subframe with configuration 1, 2, 6, or 7 (see Table 4.2 - 1)} \\ l' \bmod 2 + 5 & \text{if not in a special subframe} \end{cases}$$

$$l' = \begin{cases} 0,1,2,3 & \text{if } n_s \bmod 2 = 0 \text{ and in a special subframe with configuration 1, 2, 6, or 7 (see Table 4.2 - 1)} \\ 0,1 & \text{if } n_s \bmod 2 = 0 \text{ and not in special subframe with configuration 1, 2, 6, or 7 (see Table 4.2 - 1)} \\ 2,3 & \text{if } n_s \bmod 2 = 1 \text{ and not in special subframe with configuration 1, 2, 6, or 7 (see Table 4.2 - 1)} \end{cases}$$

$$m' = 0,1,2$$

The sequence $\bar{w}_p(i)$ is given by Table 6.10.3A.2-1.

Table 6.10.3A.2-1: The sequence $\bar{w}_p(i)$ for normal cyclic prefix

Antenna port p	$\bar{w}_p(0)$	$\bar{w}_p(1)$	$\bar{w}_p(2)$	$\bar{w}_p(3)$
------------------	----------------	----------------	----------------	----------------

107	$[+1 \ +1 \ +1 \ +1]$
108	$[+1 \ -1 \ +1 \ -1]$
109	$[+1 \ +1 \ +1 \ +1]$
110	$[+1 \ -1 \ +1 \ -1]$

Extended cyclic prefix:

$$a_{k,l}^{(p)} = w_p(l \bmod 2) \cdot r(4 \cdot l \cdot N_{\text{RB}}^{\text{max,DL}} + 4 \cdot n_{\text{PRB}} + m')$$

where

$$w_p(i) = \begin{cases} \overline{w}_p(i) & m' \bmod 2 = 0 \\ \overline{w}_p(1-i) & m' \bmod 2 = 1 \end{cases}$$

$$k = 3m' + N_{\text{sc}}^{\text{RB}} n_{\text{PRB}} + k'$$

$$k' = \begin{cases} 1 & \text{if } n_s \bmod 2 = 0 \text{ and } p \in \{107, 108\} \\ 2 & \text{if } n_s \bmod 2 = 1 \text{ and } p \in \{107, 108\} \end{cases}$$

$$l = l' \bmod 2 + 4$$

$$l' = \begin{cases} 0,1 & \text{if } n_s \bmod 2 = 0 \text{ and in a special subframe with configuration 1, 2, 3, 5 or 6 (see Table 4.2-1)} \\ 0,1 & \text{if } n_s \bmod 2 = 0 \text{ and not in a special subframe} \\ 2,3 & \text{if } n_s \bmod 2 = 1 \text{ and not in a special subframe} \end{cases}$$

$$m' = 0,1,2,3$$

The sequence $\overline{w}_p(i)$ is given by Table 6.10.3A.2-2.

Table 6.10.3A.2-2: The sequence $\overline{w}_p(i)$ for extended cyclic prefix

Antenna port p	$[\overline{w}_p(0) \ \overline{w}_p(1)]$
107	$[+1 \ +1]$
108	$[-1 \ +1]$

For extended cyclic prefix, demodulation reference signals are not supported on antenna ports 109 to 110.

For the antenna port $p = 107$ in a physical resource block n_{PRB} assigned for the SPDCCH, a part of the reference signal sequence $r(m)$ shall be mapped to complex-valued modulation symbols $a_{k,l}^{(p)}$ in a subframe according to the procedure used for UE-specific reference signals associated with subslot-PDSCH on antenna port 7 described in section 6.10.3.2 with the following amendments:

- for slot-SPDCCH, $l = l'$,
- for slot-SPDCCH in MBSFN subframes, the procedure used for the baseline pattern of UE-specific reference signals associated with subslot-PDSCH is applied
- for slot-SPDCCH in normal subframes, the procedure used for the shifted pattern of UE-specific reference signals associated with subslot-PDSCH depending on the cell-specific frequency shift ν_{shift} is applied.

Resource elements (k, l) used for transmission of demodulation reference signals to one UE on any of the antenna ports in the set S , where $S = \{107, 108\}$ or $S = \{109, 110\}$ shall

- not be used for transmission of EPDCCH/MPDCCH on any antenna port in the same slot, and
- not be used for demodulation reference signals to the same UE on any antenna port other than those in S in the same slot.

Replacing antenna port numbers 7 – 10 by 107 – 110 in Figure 6.10.3.2-3 provides an illustration of the resource elements used for demodulation reference signals associated with EPDCCH/MPDCCH for normal cyclic prefix. Replacing antenna port numbers 7 – 8 by 107 – 108 in Figure 6.10.3.2-4 provides an illustration of the resource

elements used for demodulation reference signals associated with EPDCCH/MPDCCH for extended cyclic prefix.

For frame structure type 3, for EPDCCH in a subframe with the same duration as the DwPTS duration of a special subframe configuration, the mapping of the demodulation reference signals to the resource elements is the same as that for the corresponding special subframe configuration.

For BL/CE UEs, if higher layer parameter *resourceReservationDedicatedDL* is configured, then in case of MPDCCH transmission associated with C-RNTI or SPS C-RNTI using UE-specific MPDCCH search space,

- If all OFDM symbols in a PRB are reserved, the demodulation reference signal transmission in that PRB is dropped.

6.10.4 Positioning reference signals

Positioning reference signals shall only be transmitted in resource blocks in downlink subframes configured for positioning reference signal transmission. If both normal and MBSFN subframes are configured as positioning subframes within a cell, the OFDM symbols in a MBSFN subframe configured for positioning reference signal transmission shall use the same cyclic prefix as used for subframe #0. If only MBSFN subframes are configured as positioning subframes within a cell, the OFDM symbols configured for positioning reference signals in the MBSFN region of these subframes shall use extended cyclic prefix length. In a subframe configured for positioning reference signal transmission, the starting positions of the OFDM symbols configured for positioning reference signal transmission shall be identical to those in a subframe in which all OFDM symbols have the same cyclic prefix length as the OFDM symbols configured for positioning reference signal transmission.

Positioning reference signals are transmitted on antenna port 6.

The positioning reference signals shall not be mapped to resource elements (k, l) allocated to the core part of the PBCH, PSS or SSS regardless of their antenna port p .

Positioning reference signals are defined for $\Delta f = 15$ kHz only.

6.10.4.1 Sequence generation

The reference-signal sequence $r_{l,n_s}(m)$ is defined by

$$r_{l,n_s}(m) = \frac{1}{\sqrt{2}}(1 - 2 \cdot c(2m)) + j \frac{1}{\sqrt{2}}(1 - 2 \cdot c(2m+1)), \quad m = 0, 1, \dots, 2N_{\text{RB}}^{\text{max,DL}} - 1$$

where n_s is the slot number within a radio frame, l is the OFDM symbol number within the slot. The pseudo-random sequence $c(i)$ is defined in clause 7.2. The pseudo-random sequence generator shall be initialised with

$c_{\text{init}} = 2^{28} \cdot \lfloor N_{\text{ID}}^{\text{PRS}} / 512 \rfloor + 2^{10} \cdot (7 \cdot (n_s + 1) + l + 1) \cdot (2 \cdot (N_{\text{ID}}^{\text{PRS}} \bmod 512) + 1) + 2 \cdot (N_{\text{ID}}^{\text{PRS}} \bmod 512) + N_{\text{CP}}$ at the start of each OFDM symbol where $N_{\text{ID}}^{\text{PRS}} \in \{0, 1, \dots, 4095\}$ equals $N_{\text{ID}}^{\text{cell}}$ unless configured by higher layers and where

$$N_{\text{CP}} = \begin{cases} 1 & \text{for normal CP} \\ 0 & \text{for extended CP} \end{cases}$$

6.10.4.2 Mapping to resource elements

If PRS frequency hopping is not configured by higher layers, the reference signal sequence $r_{l,n_s}(m)$ shall be mapped to complex-valued modulation symbols $a_{k,l}^{(p)}$ used as reference signal for antenna port $p = 6$ in slot n_s according to

$$a_{k,l}^{(p)} = r_{l,n_s}(m')$$

where

Normal cyclic prefix:

$$k = 6 \left(m + N_{\text{RB}}^{\text{DL}} - N_{\text{RB}}^{\text{PRS}} \right) + (6 - l + v_{\text{shift}}) \bmod 6$$

$$l = \begin{cases} 3,5,6 & \text{if } n_s \bmod 2 = 0 \\ 1,2,3,5,6 & \text{if } n_s \bmod 2 = 1 \text{ and (1 or 2 PBCH antenna ports)} \\ 2,3,5,6 & \text{if } n_s \bmod 2 = 1 \text{ and (4 PBCH antenna ports)} \end{cases}$$

$$m = 0, 1, \dots, 2 \cdot N_{\text{RB}}^{\text{PRS}} - 1$$

$$m' = m + N_{\text{RB}}^{\text{max,DL}} - N_{\text{RB}}^{\text{PRS}}$$

Extended cyclic prefix:

$$k = 6 \left(m + N_{\text{RB}}^{\text{DL}} - N_{\text{RB}}^{\text{PRS}} \right) + (5 - l + v_{\text{shift}}) \bmod 6$$

$$l = \begin{cases} 4,5 & \text{if } n_s \bmod 2 = 0 \\ 1,2,4,5 & \text{if } n_s \bmod 2 = 1 \text{ and (1 or 2 PBCH antenna ports)} \\ 2,4,5 & \text{if } n_s \bmod 2 = 1 \text{ and (4 PBCH antenna ports)} \end{cases}$$

$$m = 0, 1, \dots, 2 \cdot N_{\text{RB}}^{\text{PRS}} - 1$$

$$m' = m + N_{\text{RB}}^{\text{max,DL}} - N_{\text{RB}}^{\text{PRS}}$$

The bandwidth for positioning reference signals $N_{\text{RB}}^{\text{PRS}}$ is configured by higher layers and the cell-specific frequency shift is given by $v_{\text{shift}} = N_{\text{ID}}^{\text{PRS}} \bmod 6$ where $N_{\text{ID}}^{\text{PRS}} = N_{\text{ID}}^{\text{cell}}$ if no value for $N_{\text{ID}}^{\text{PRS}}$ is configured by higher layers.

If PRS frequency hopping is configured by higher layers, a PRS frequency hopping configuration provided by higher layers contains the following:

- The length of the PRS occasion group, $L_{\text{GROUP}}^{\text{PRS}}$
- Number of PRS frequency hopping bands, $N_{\text{BAND}}^{\text{PRS}}$
- n_i^{RB} defined as twice the starting PRB index of PRS frequency hopping band i where
 - $n_i^{\text{RB}} = N_{\text{RB}}^{\text{DL}} - N_{\text{RB}}^{\text{PRS}}$ if $i = 0$,
 - $n_i^{\text{RB}} = 2 \cdot \tilde{n}_i^{\text{RB}}$ where \tilde{n}_i^{RB} is the index of the first PRB in the PRS frequency hopping narrowband configured by higher layers if $i \in \{1, \dots, N_{\text{BAND}}^{\text{PRS}} - 1\}$

If PRS frequency hopping is configured by higher layers, the reference signal sequence $r_{l,n_s}(m)$ in the PRS occasion j , $j = 0, \dots, L_{\text{GROUP}}^{\text{PRS}} - 1$, in the PRS occasion group shall be mapped to complex-valued modulation symbols $a_{k,l}^{(p)}$ used as reference signal for antenna port $p = 6$ in slot n_s according to

$$a_{k,l}^{(p)} = r_{l,n_s}(m')$$

where

- for normal cyclic prefix

$$i = j \bmod N_{\text{BAND}}^{\text{PRS}}$$

$$k = 6 \left(m + n_i^{\text{RB}} \right) + (6 - l + v_{\text{shift}}) \bmod 6$$

$$l = \begin{cases} 3,5,6 & \text{if } n_s \bmod 2 = 0 \\ 1,2,3,5,6 & \text{if } n_s \bmod 2 = 1 \text{ and (1 or 2 PBCH antenna ports)} \\ 2,3,5,6 & \text{if } n_s \bmod 2 = 1 \text{ and (4 PBCH antenna ports)} \end{cases}$$

$$m = 0, 1, \dots, 2 \cdot N_{\text{RB}}^{\text{PRS}} - 1$$

$$m' = m + n_i^{\text{RB}} + N_{\text{RB}}^{\text{max,DL}} - N_{\text{RB}}^{\text{DL}}$$

- for extended cyclic prefix

$$i = j \bmod N_{\text{BAND}}^{\text{PRS}}$$

$$k = 6(m + n_1^{\text{RB}}) + (5 - l + v_{\text{shift}}) \bmod 6$$

$$l = \begin{cases} 4,5 & \text{if } n_s \bmod 2 = 0 \\ 1,2,4,5 & \text{if } n_s \bmod 2 = 1 \text{ and (1 or 2 PBCH antenna ports)} \\ 2,4,5 & \text{if } n_s \bmod 2 = 1 \text{ and (4 PBCH antenna ports)} \end{cases}$$

$$m = 0, 1, \dots, 2 \cdot N_{\text{RB}}^{\text{PRS}} - 1$$

$$m' = m + n_1^{\text{RB}} + N_{\text{RB}}^{\text{max,DL}} - N_{\text{RB}}^{\text{DL}}$$

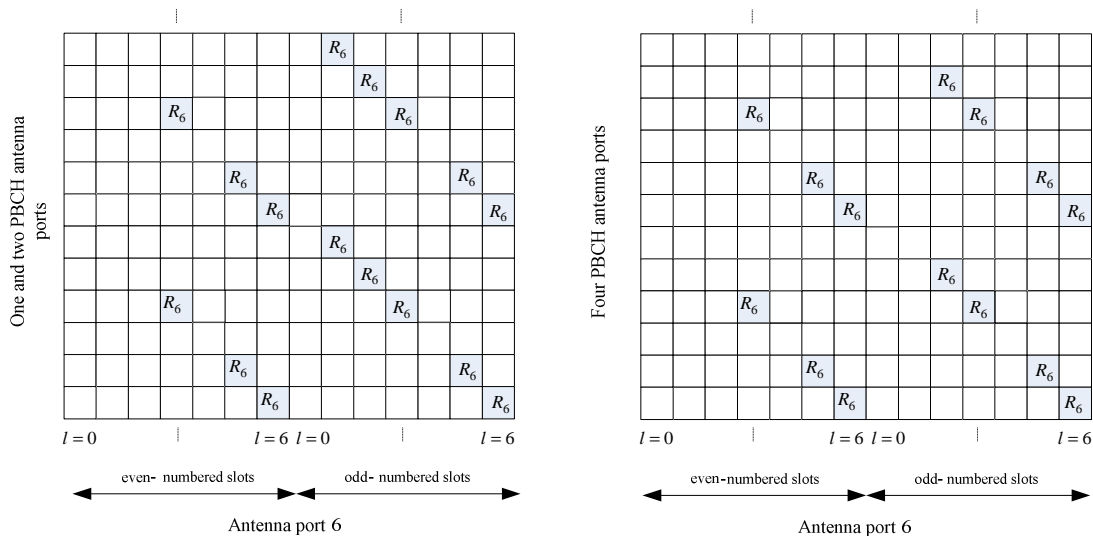

Figure 6.10.4.2-1: Mapping of positioning reference signals (normal cyclic prefix)

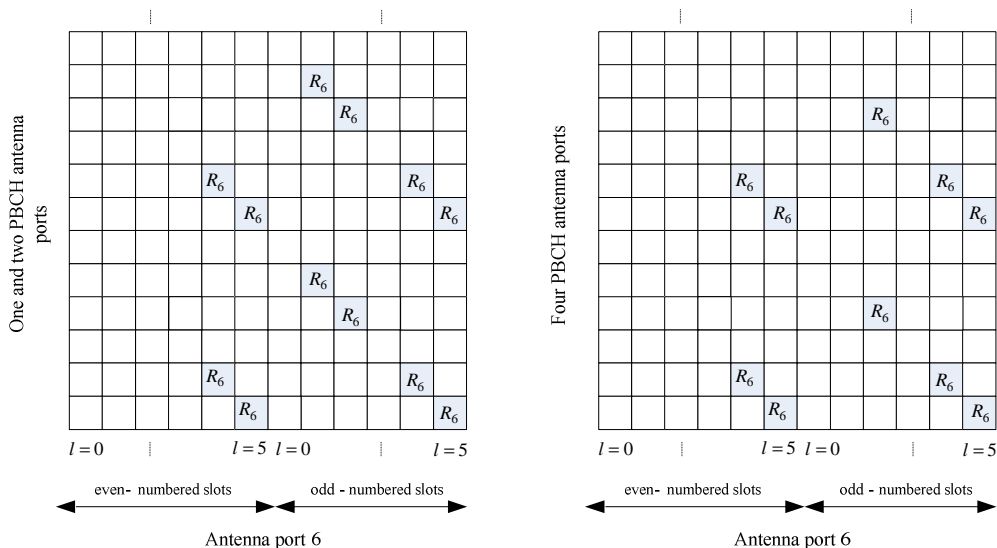

Figure 6.10.4.2-2: Mapping of positioning reference signals (extended cyclic prefix)

6.10.4.3 Positioning reference signal subframe configuration

The subframe configuration period T_{PRS} and the subframe offset Δ_{PRS} for the transmission of positioning reference signals are listed in Table 6.10.4.3-1. The PRS configuration index I_{PRS} is configured by higher layers. Positioning

reference signals are transmitted only in configured DL subframes. Positioning reference signals shall not be transmitted in DwPTS. Positioning reference signals shall be transmitted in N_{PRS} consecutive downlink subframes, where N_{PRS} is configured by higher layers.

The positioning reference signal instances, for the first subframe of the N_{PRS} downlink subframes, shall satisfy $(10 \times n_f + \lfloor n_s / 2 \rfloor - \Delta_{\text{PRS}}) \bmod T_{\text{PRS}} = 0$.

Table 6.10.4.3-1: Positioning reference signal subframe configuration

PRS configuration Index I_{PRS}	PRS periodicity T_{PRS} (subframes)	PRS subframe offset Δ_{PRS} (subframes)
0 – 159	160	I_{PRS}
160 – 479	320	$I_{\text{PRS}} - 160$
480 – 1119	640	$I_{\text{PRS}} - 480$
1120 – 2399	1280	$I_{\text{PRS}} - 1120$
2400 – 2404	5	$I_{\text{PRS}} - 2400$
2405 – 2414	10	$I_{\text{PRS}} - 2405$
2415 – 2434	20	$I_{\text{PRS}} - 2415$
2435 – 2474	40	$I_{\text{PRS}} - 2435$
2475 – 2554	80	$I_{\text{PRS}} - 2475$
2555-4095	Reserved	

6.10.5 CSI reference signals

CSI reference signals are transmitted on 1, 2, 4, 8, 12, 16, 20, 24, 28, or 32 antenna ports using $p = 15$, $p = 15, 16$, $p = 15, \dots, 18$, $p = 15, \dots, 22$, $p = 15, \dots, 26$, $p = 15, \dots, 30$, $p = 15, \dots, 34$, $p = 15, \dots, 38$, $p = 15, \dots, 42$ and $p = 15, \dots, 46$, respectively.

For CSI reference signals using more than eight antenna ports, $N_{\text{res}}^{\text{CSI}} > 1$ CSI-RS configurations in the same subframe, numbered from 0 to $N_{\text{res}}^{\text{CSI}} - 1$, where value 0 corresponds to the configured *resourceConfig-r11* or *resourceConfig-r10* and value k ($k > 0$) corresponds to the configured k -th entry of *NZP-ResourceConfig-r13* from an aggregated list consisting of *nzp-resourceConfigList-r13* followed by *nzp-resourceConfigListExt-r14* (if configured), are aggregated to obtain $N_{\text{res}}^{\text{CSI}} N_{\text{ports}}^{\text{CSI}}$ antenna ports in total. Each CSI-RS configuration in such an aggregation corresponds to

$N_{\text{ports}}^{\text{CSI}} \in \{4, 8\}$ antenna ports and one of the configurations in the range 0-19 in Table 6.10.5.2-1 for normal cyclic prefix, and one of the configurations in the range 0-15 in Table 6.10.5.2-2 for extended cyclic prefix. The supported configurations of aggregated CSI-RS configurations are shown in Table 6.10.5-1. If the higher layer parameter *NZP-TransmissionComb* is not configured, $N_{\text{res}}^{\text{CSI}}$ unique CSI-RS configurations from Table 6.10.5.2-1 for normal cyclic prefix and from Table 6.10.5.2-2 for extended cyclic prefix are aggregated to form 12, 16, 20, 24, 28, or 32 antenna ports.

For CSI reference signals using more than sixteen antenna ports, when higher layer parameter *NZP-TransmissionComb* is configured, the number of unique CSI-RS configurations from Table 6.10.5.2-1 for normal cyclic prefix and from Table 6.10.5.2-2 for extended cyclic prefix that are aggregated to form 20, 24, 28, or 32 antenna ports can be less than or equal to $N_{\text{res}}^{\text{CSI}}$. The number of antenna ports within each such unique CSI-RS resource configuration is an integer multiple of $N_{\text{ports}}^{\text{CSI}}$.

CSI reference signals are defined for $\Delta f = 15$ kHz only.

Table 6.10.5-1: Aggregation of CSI-RS configurations.

Total number of antenna ports $N_{\text{res}}^{\text{CSI}} N_{\text{ports}}^{\text{CSI}}$	Number of antenna ports per CSI-RS configuration $N_{\text{ports}}^{\text{CSI}}$	Number of CSI-RS configurations $N_{\text{res}}^{\text{CSI}}$
12	4	3

16	8	2
20	4	5
24	8	3
28	4	7
32	8	4

6.10.5.1 Sequence generation

The reference-signal sequence $r_{l,n_s}(m)$ is defined by

$$r_{l,n_s}(m) = \frac{1}{\sqrt{2}}(1 - 2 \cdot c(2m)) + j \frac{1}{\sqrt{2}}(1 - 2 \cdot c(2m+1)), \quad m = 0, 1, \dots, N_{\text{RB}}^{\text{max,DL}} - 1$$

where n_s is the slot number within a radio frame and l is the OFDM symbol number within the slot. The pseudo-random sequence $c(i)$ is defined in clause 7.2. The pseudo-random sequence generator shall be initialised with $c_{\text{init}} = 2^{10} \cdot (7 \cdot (n'_s + 1) + l + 1) \cdot (2 \cdot N_{\text{ID}}^{\text{CSI}} + 1) + 2 \cdot N_{\text{ID}}^{\text{CSI}} + N_{\text{CP}}$ at the start of each OFDM symbol where

$$n'_s = \begin{cases} 10 \lfloor n_s / 10 \rfloor + n_s \bmod 2 & \text{for frame structure type 3 when the CSI - RS is part of a DRS} \\ n_s & \text{otherwise} \end{cases}$$

$$N_{\text{CP}} = \begin{cases} 1 & \text{for normal CP} \\ 0 & \text{for extended CP} \end{cases}$$

The quantity $N_{\text{ID}}^{\text{CSI}}$ equals $N_{\text{ID}}^{\text{cell}}$ unless configured by higher layers.

6.10.5.2 Mapping to resource elements

In subframes configured for CSI reference signal transmission, the reference signal sequence $r_{l,n_s}(m)$ shall be mapped to complex-valued modulation symbols $a_{k,l}^{(p)}$ used as reference symbols on antenna port p . The mapping depends on the higher-layer parameter *CDMType*.

For the case of *CDMType* is not configured or is configured to CDM2:

$$a_{k,l}^{(p')} = w_{l'} \cdot r_{l,n_s}(m')$$

where

$$\begin{aligned}
 k = k' + 12m + \begin{cases} -0 & \text{for } p' \in \{15,16\}, \text{ normal cyclic prefix} \\ -6 & \text{for } p' \in \{17,18\}, \text{ normal cyclic prefix} \\ -1 & \text{for } p' \in \{19,20\}, \text{ normal cyclic prefix} \\ -7 & \text{for } p' \in \{21,22\}, \text{ normal cyclic prefix} \\ -0 & \text{for } p' \in \{15,16\}, \text{ extended cyclic prefix} \\ -3 & \text{for } p' \in \{17,18\}, \text{ extended cyclic prefix} \\ -6 & \text{for } p' \in \{19,20\}, \text{ extended cyclic prefix} \\ -9 & \text{for } p' \in \{21,22\}, \text{ extended cyclic prefix} \end{cases} \\
 l = l' + \begin{cases} l'' & \text{CSI reference signal configurations 0-19, normal cyclic prefix} \\ 2l'' & \text{CSI reference signal configurations 20-31, normal cyclic prefix} \\ l'' & \text{CSI reference signal configurations 0-27, extended cyclic prefix} \end{cases} \\
 w_{l''} = \begin{cases} 1 & p' \in \{15,17,19,21\} \\ (-1)^{l''} & p' \in \{16,18,20,22\} \end{cases} \\
 l'' = 0,1 \\
 m' = m + \left\lfloor \frac{N_{\text{RB}}^{\text{max,DL}} - N_{\text{RB}}^{\text{DL}}}{2} \right\rfloor
 \end{aligned}$$

For the case of *CDMType* equal to *CDM4*:

$$a_{k,l}^{(p')} = w_{p'}(i) \cdot r_{l,n_s}(m')$$

where

$$\begin{aligned}
 k = k' + 12m - \begin{cases} k'' & \text{for } p' \in \{15,16,19,20\}, \text{ normal cyclic prefix, } N_{\text{ports}}^{\text{CSI}} = 8 \\ k'' + 6 & \text{for } p' \in \{17,18,21,22\}, \text{ normal cyclic prefix, } N_{\text{ports}}^{\text{CSI}} = 8 \\ 6k'' & \text{for } p' \in \{15,16,17,18\}, \text{ normal cyclic prefix, } N_{\text{ports}}^{\text{CSI}} = 4 \end{cases} \\
 l = l' + \begin{cases} l'' & \text{CSI reference signal configurations 0-19, normal cyclic prefix} \\ 2l'' & \text{CSI reference signal configurations 20-31, normal cyclic prefix} \end{cases} \\
 l'' = 0,1 \\
 k'' = 0,1 \\
 i = 2k'' + l'' \\
 m' = m + \left\lfloor \frac{N_{\text{RB}}^{\text{max,DL}} - N_{\text{RB}}^{\text{DL}}}{2} \right\rfloor
 \end{aligned}$$

and where $w_{p'}(i)$ is given by Table 6.10.5.2-0.

Table 6.10.5.2-0: The sequence $w_{p'}(i)$ for *CDM4*.

$N_{\text{ports}}^{\text{CSI}} = 4$	$N_{\text{ports}}^{\text{CSI}} = 8$	$[w_{p'}(0) \ w_{p'}(1) \ w_{p'}(2) \ w_{p'}(3)]$
15	15,17	[1 1 1 1]
16	16,18	[1 -1 1 -1]
17	19,21	[1 1 -1 -1]
18	20,22	[1 -1 -1 1]

If neither of the higher-layer parameters *NZP-FrequencyDensity* and *NZP-TransmissionComb* are configured, $m = 0, 1, \dots, N_{\text{RB}}^{\text{DL}} - 1$.

If the UE is configured with one or more of the parameters *NZP-FrequencyDensity* and *NZP-TransmissionComb*,

- if either *NZP-FrequencyDensity* equals 1, $m = 0, 1, \dots, N_{\text{RB}}^{\text{DL}} - 1$
- if *NZP-FrequencyDensity* equals 1/2 and *NZP-TransmissionComb* equals 0, $m = 0, 2, \dots, N_{\text{RB}}^{\text{DL}} - 1 - \left((N_{\text{RB}}^{\text{DL}} - 1) \bmod 2 \right)$
- if *NZP-FrequencyDensity* equals 1/2 and *NZP-TransmissionComb* equals 1, $m = 1, 3, \dots, N_{\text{RB}}^{\text{DL}} - 1 - \left((N_{\text{RB}}^{\text{DL}} - 2) \bmod 2 \right)$
- if *NZP-FrequencyDensity* equals 1/3 and *NZP-TransmissionComb* equals 0, $m = 0, 3, \dots, N_{\text{RB}}^{\text{DL}} - 1 - \left((N_{\text{RB}}^{\text{DL}} - 1) \bmod 3 \right)$
- if *NZP-FrequencyDensity* equals 1/3 and *NZP-TransmissionComb* equals 1, $m = 1, 4, \dots, N_{\text{RB}}^{\text{DL}} - 1 - \left((N_{\text{RB}}^{\text{DL}} - 2) \bmod 3 \right)$
- if *NZP-FrequencyDensity* equals 1/3 and *NZP-TransmissionComb* equals 2, $m = 2, 5, \dots, N_{\text{RB}}^{\text{DL}} - 1 - \left((N_{\text{RB}}^{\text{DL}} - 3) \bmod 3 \right)$

The quantity (k', l') and the necessary conditions on n_s are given by Tables 6.10.5.2-1 and 6.10.5.2-2 for normal and extended cyclic prefix, respectively.

The relation between the antenna port number p and the quantity p' depends on the number of CSI-RS antenna ports:

- for CSI reference signals using up to eight antenna ports, $p = p'$
- for CSI reference signals using more than eight antenna ports when the higher-layer parameter *CDMType* equals *CDM2*

$$p = \begin{cases} p' + \frac{N_{\text{ports}}^{\text{CSI}}}{2} i' & \text{for } p' \in \{15, \dots, 15 + N_{\text{ports}}^{\text{CSI}}/2 - 1\} \\ p' + \frac{N_{\text{ports}}^{\text{CSI}}}{2} (i' + N_{\text{res}}^{\text{CSI}} - 1) & \text{for } p' \in \{15 + N_{\text{ports}}^{\text{CSI}}/2, \dots, 15 + N_{\text{ports}}^{\text{CSI}} - 1\} \end{cases}$$

where $i' \in \{0, 1, \dots, N_{\text{res}}^{\text{CSI}} - 1\}$ is the CSI-RS resource number.

- for CSI reference signals using more than eight antenna ports when the higher-layer parameter *CDMType* equals *CDM4*, antenna port number $p = i' N_{\text{ports}}^{\text{CSI}} + p'$ where $p' \in \{15, 16, \dots, 15 + N_{\text{ports}}^{\text{CSI}} - 1\}$ for CSI-RS resource number $i' \in \{0, 1, \dots, N_{\text{res}}^{\text{CSI}} - 1\}$.

For the case of *CDMType* equal to *CDM8* and the number of CSI-RS antenna ports equal to 32:

$$a_{k,l}^{(p)} = w_p(i) \cdot r_{l,n_s}(m')$$

where

$$\begin{aligned}
 k &= k' + 12m + \begin{cases} -0 & \text{for } p' \in \{15,16\}, \text{ normal cyclic prefix} \\ -6 & \text{for } p' \in \{17,18\}, \text{ normal cyclic prefix} \\ -1 & \text{for } p' \in \{19,20\}, \text{ normal cyclic prefix} \\ -7 & \text{for } p' \in \{21,22\}, \text{ normal cyclic prefix} \\ -0 & \text{for } p' \in \{15,16\}, \text{ extended cyclic prefix} \\ -3 & \text{for } p' \in \{17,18\}, \text{ extended cyclic prefix} \\ -6 & \text{for } p' \in \{19,20\}, \text{ extended cyclic prefix} \\ -9 & \text{for } p' \in \{21,22\}, \text{ extended cyclic prefix} \end{cases} \\
 l &= l' + \begin{cases} l'' & \text{CSI reference signal configurations 0 - 19, normal cyclic prefix} \\ 2l'' & \text{CSI reference signal configurations 20 - 31, normal cyclic prefix} \\ l'' & \text{CSI reference signal configurations 0 - 27, extended cyclic prefix} \end{cases} \\
 l'' &= 0,1 \\
 q &= \begin{cases} 0 & \text{if } k - k' - 12m = -0, \text{ normal cyclic prefix} \\ 1 & \text{if } k - k' - 12m = -6, \text{ normal cyclic prefix} \\ 2 & \text{if } k - k' - 12m = -1, \text{ normal cyclic prefix} \\ 3 & \text{if } k - k' - 12m = -7, \text{ normal cyclic prefix} \\ 0 & \text{if } k - k' - 12m = -0, \text{ extended cyclic prefix} \\ 1 & \text{if } k - k' - 12m = -3, \text{ extended cyclic prefix} \\ 2 & \text{if } k - k' - 12m = -6, \text{ extended cyclic prefix} \\ 3 & \text{if } k - k' - 12m = -9, \text{ extended cyclic prefix} \end{cases} \\
 m' &= m + \left\lfloor \frac{N_{RB}^{\max,DL} - N_{RB}^{DL}}{2} \right\rfloor \\
 m &= 0,1,\dots,N_{RB}^{DL} - 1
 \end{aligned}$$

The resource elements for the \bar{q}^{th} CDM8 pattern, where $\bar{q} = 0,1,2,3$, are determined by aggregating pairs of resource elements (k,l) satisfying $q = \bar{q}$ from the N_{res}^{CSI} aggregated CSI-RS configurations, where at most one pair of resource elements is drawn from each of the N_{res}^{CSI} aggregated CSI-RS configurations. For the case of *CDMType* equal to *CDM8* and the number of CSI-RS antenna ports equal to 32, the aggregated CSI-RS configurations from Table 6.10.5.2-1 for normal cyclic prefix and from Table 6.10.5.2-2 for extended cyclic prefix are restricted to one of $\{0,1,2,3\}$, $\{0,2,3,4\}$, or $\{1,2,3,4\}$. Antenna port number $p = i'N_{ports}^{\text{CSI}} + p'$ where $p' \in \{5,16,\dots,15 + N_{ports}^{\text{CSI}} - 1\}$ for CSI-RS resource number $i' \in \{0,1,\dots,N_{res}^{\text{CSI}} - 1\}$. The sequence $w_p(i)$ is given by Table 6.10.5.2-0A, where $i = 2i' + l''$.

Table 6.10.5.2-0A: The sequence $w_p(i)$ for CDM8 with 32 CSI-RS antenna ports.

p	$[w_p(0) \ w_p(1) \ w_p(2) \ w_p(3) \ w_p(4) \ w_p(5) \ w_p(6) \ w_p(7)]$
15, 17, 19, 21	$[1 \ 1 \ 1 \ 1 \ 1 \ 1 \ 1 \ 1]$
16, 18, 20, 22	$[1 \ -1 \ 1 \ -1 \ 1 \ -1 \ 1 \ -1]$
23, 25, 27, 29	$[1 \ 1 \ -1 \ -1 \ 1 \ 1 \ -1 \ -1]$
24, 26, 28, 30	$[1 \ -1 \ -1 \ 1 \ 1 \ -1 \ -1 \ 1]$
31, 33, 35, 37	$[1 \ 1 \ 1 \ 1 \ -1 \ -1 \ -1 \ -1]$
32, 34, 36, 38	$[1 \ -1 \ 1 \ -1 \ -1 \ 1 \ -1 \ 1]$
39, 41, 43, 45	$[1 \ 1 \ -1 \ -1 \ -1 \ -1 \ 1 \ 1]$
40, 42, 44, 46	$[1 \ -1 \ -1 \ 1 \ -1 \ 1 \ 1 \ -1]$

For the case of $CDMType$ equal to $CDM8$ and the number of CSI-RS antenna ports equal to 24:

$$a_{k,l}^{(p)} = w_p(i) \cdot r_{l,n_s}(m')$$

where

$$k = k' + 12m - \begin{cases} k'' & \text{for } p' \in \{15, 16, 19, 20\}, \text{ normal cyclic prefix, } N_{\text{ports}}^{\text{CSI}} = 8 \\ k'' + 6 & \text{for } p' \in \{17, 18, 21, 22\}, \text{ normal cyclic prefix, } N_{\text{ports}}^{\text{CSI}} = 8 \end{cases}$$

$$l = l' + \begin{cases} l'' & \text{CSI reference signal configurations 0-19, normal cyclic prefix} \\ 2l'' & \text{CSI reference signal configurations 20-31, normal cyclic prefix} \end{cases}$$

$$l'' = 0, 1$$

$$k'' = 0, 1$$

$$q = \begin{cases} 0 & \text{if } k - k' - 12m + k'' = 0, \text{ normal cyclic prefix,} \\ 1 & \text{if } k - k' - 12m + k'' = -6, \text{ normal cyclic prefix} \end{cases}$$

$$m' = m + \left\lfloor \frac{N_{\text{RB}}^{\text{max,DL}} - N_{\text{RB}}^{\text{DL}}}{2} \right\rfloor$$

$$m = 0, 1, \dots, N_{\text{RB}}^{\text{DL}} - 1$$

For the case of $CDMType$ equal to $CDM8$ and the number of CSI-RS antenna ports equal to 24, the aggregated CSI-RS configurations from Table 6.10.5.2-1 for normal cyclic prefix are restricted to $\{1, 2, 3\}$ in that order. Resource elements for $CDM8$ patterns are determined as follows:

- Aggregating resource element quadruplet (k, l) satisfying $q = 0$ from CSI-RS configuration 1 with resource element quadruplet (k, l) satisfying $q = 0$ from CSI-RS configuration 2
- Aggregating resource element quadruplet (k, l) satisfying $q = 0$ from CSI-RS configuration 3 with resource element quadruplet (k, l) satisfying $q = 1$ from CSI-RS configuration 1
- Aggregating resource element quadruplet (k, l) satisfying $q = 1$ from CSI-RS configuration 2 with resource element quadruplet (k, l) satisfying $q = 1$ from CSI-RS configuration 3

Antenna port number $p = i' N_{\text{ports}}^{\text{CSI}} + p'$ where $p' \in \{15, 16, \dots, 15 + N_{\text{ports}}^{\text{CSI}} - 1\}$ for CSI-RS resource number $i' \in \{0, 1, \dots, N_{\text{res}}^{\text{CSI}} - 1\}$. The sequence $w_p(i)$ is given by Table 6.10.5.2-0B. The sequence index i is determined as follows:

- For resource element quadruplet (k, l) satisfying $q = 0$ from CSI-RS configuration 1, resource element quadruplet (k, l) satisfying $q = 1$ from CSI-RS configuration 2, or resource element quadruplet (k, l) satisfying $q = 0$ from CSI-RS configuration 3, $i = 2k'' + l''$.
- For resource element quadruplet (k, l) satisfying $q = 1$ from CSI-RS configuration 1, resource element quadruplet (k, l) satisfying $q = 0$ from CSI-RS configuration 2, or resource element quadruplet (k, l) satisfying $q = 1$ from CSI-RS configuration 3, $i = 2k'' + l'' + 4$.

Table 6.10.5.2-0B: The sequence $w_p(i)$ for $CDM8$ with 24 CSI-RS antenna ports.

p	$[w_p(0) \ w_p(1) \ w_p(2) \ w_p(3) \ w_p(4) \ w_p(5) \ w_p(6) \ w_p(7)]$
15, 25, 31	$[1 \ 1 \ 1 \ 1 \ 1 \ 1 \ 1 \ 1]$

16, 26, 32	$[1 \ -1 \ 1 \ -1 \ 1 \ -1 \ 1 \ -1]$
19, 29, 35	$[1 \ 1 \ -1 \ -1 \ 1 \ 1 \ -1 \ -1]$
20, 30, 36	$[1 \ -1 \ -1 \ 1 \ 1 \ -1 \ -1 \ 1]$
17, 23, 33	$[1 \ 1 \ 1 \ 1 \ -1 \ -1 \ -1 \ -1]$
18, 24, 34	$[1 \ -1 \ 1 \ -1 \ -1 \ 1 \ -1 \ 1]$
21, 27, 37	$[1 \ 1 \ -1 \ -1 \ -1 \ -1 \ 1 \ 1]$
22, 28, 38	$[1 \ -1 \ -1 \ 1 \ -1 \ 1 \ 1 \ -1]$

Multiple CSI reference signal configurations can be used in a given cell. A UE can be configured with multiple sets of CSI reference signals,

- one or more configurations for CSI reporting for which the UE shall assume non-zero transmission power for the CSI-RS, and
- zero or more configurations for which the UE shall assume zero transmission power, and
- zero or more configurations valid across the system downlink bandwidth as part of the discovery signals for which the UE shall assume non-zero transmission power for the CSI-RS.

The CSI-RS configurations for which the UE shall assume non-zero transmission power are provided by higher layers.

The CSI-RS configurations for which the UE shall assume zero transmission power in a subframe are given by a bitmap derived according to clause 7.2.7 in 3GPP TS 36.213 [4]. For each bit set to one in the 16-bit bitmap, the UE shall assume zero transmission power for the resource elements corresponding to the four CSI reference signal column in Tables 6.10.5.2-1 and 6.10.5.2-2 for normal and extended cyclic prefix, respectively, except for resource elements that overlap with those for which the UE shall assume non-zero transmission power CSI-RS as configured by higher layers. The most significant bit corresponds to the lowest CSI reference signal configuration index and subsequent bits in the bitmap correspond to configurations with indices in increasing order.

CSI reference signals not corresponding to higher layer configured parameters *csi-RS-ConfigNZP-ApList* or *csi-RS-ConfigZP-ApList* can only occur in

- downlink slots where $n_s \bmod 2$ fulfils the condition in Tables 6.10.5.2-1 and 6.10.5.2-2 for normal and extended cyclic prefix, respectively, and
- where the subframe number fulfils the conditions in clause 6.10.5.3.

CSI reference signals corresponding to either higher layer configured parameter *csi-RS-ConfigNZP-ApList* or *csi-RS-ConfigZP-ApList* can only occur in

- downlink slots where $n_s \bmod 2$ fulfils the condition in Tables 6.10.5.2-1 and 6.10.5.2-2 for normal and extended cyclic prefix, respectively.

The UE shall assume that CSI reference signals are not transmitted

- in the DwPTS for special subframe configuration 0, 5, 9 and 10 for normal cyclic prefix and special subframe configuration 0, 4 and 7 for extended cyclic prefix, in case of frame structure type 2,
- in the DwPTS for normal CP for the case of *CDMTtype* equal to *CDM8* and the number of CSI-RS antenna ports equal to 24,
- in subframes where PDSCH/EPDCCH transmission starts in the second slot of a subframe for frame structure type 3,
- in subframes where PDSCH/EPDCCH transmission ends prior to the end of a subframe for frame structure type 3,
- in an empty subframe where there is no PDSCH or discovery signal transmission for frame structure type 3,

- in subframes where transmission of a CSI-RS would collide with *SystemInformationBlockType1* messages,
- in the primary cell in subframes configured for transmission of paging messages in the primary cell for any UE with the cell-specific paging configuration.

For special subframe configuration {1, 2, 6, or 7}, a UE does not expect to be configured with one of CSI-RS configurations {1, 2, 3, 4, 6, 7, 8, 9, 12, 13, 14, 15, 16, 17} in DwPTS for normal CP.

The UE shall assume that none of the CSI reference signals corresponding to a CSI reference signal configuration are transmitted in subframes where transmission of any of those CSI reference signals would collide with transmission of synchronization signals or the core part of PBCH.

Resource elements (k, l) used for transmission of CSI reference signals on any of the antenna ports in the set S , where $S = \{15\}$, $S = \{15,16\}$, $S = \{17,18\}$, $S = \{19,20\}$, $S = \{21,22\}$, $S = \{23,24\}$, $S = \{25,26\}$, $S = \{27,28\}$, $S = \{29,30\}$, $S = \{31,32\}$, $S = \{33,34\}$, $S = \{35,36\}$, $S = \{37,38\}$, $S = \{39,40\}$, $S = \{41,42\}$, $S = \{43,44\}$ or $S = \{45,46\}$ shall not be used for transmission of PDSCH on any antenna port in the same slot if higher layer parameter *CDMType* is not configured, or is configured to *CDM2*.

Resource elements (k, l) used for transmission of CSI reference signals on any of the antenna ports in the set S , where

- $S = \{15,16,17,18\}$, $S = \{19,20,21,22\}$ or $S = \{23,24,25,26\}$ for CSI reference signals on 12 ports, or
- $S = \{15,16,19,20\}$, $S = \{17,18,21,22\}$, $S = \{23,24,27,28\}$ or $S = \{25,26,29,30\}$ for CSI reference signals on 16 ports, or
- $S = \{15,16,17,18\}$, $S = \{19,20,21,22\}$, $S = \{23,24,25,26\}$, $S = \{27,28,29,30\}$ or $S = \{31,32,33,34\}$ for CSI reference signals on 20 ports, or
- $S = \{15,16,19,20\}$, $S = \{17,18,21,22\}$, $S = \{23,24,27,28\}$, $S = \{25,26,29,30\}$, $S = \{31,32,35,36\}$ or $S = \{33,34,37,38\}$ for CSI reference signals on 24 ports, or
- $S = \{15,16,17,18\}$, $S = \{19,20,21,22\}$, $S = \{23,24,25,26\}$, $S = \{27,28,29,30\}$, $S = \{31,32,33,34\}$, $S = \{35,36,37,38\}$ or $S = \{39,40,41,42\}$ for CSI reference signals on 28 ports, or
- $S = \{15,16,19,20\}$, $S = \{17,18,21,22\}$, $S = \{23,24,27,28\}$, $S = \{25,26,29,30\}$, $S = \{31,32,35,36\}$, $S = \{33,34,37,38\}$, $S = \{39,40,43,44\}$ or $S = \{41,42,45,46\}$ for CSI reference signals on 32 ports

shall not be used for transmission of PDSCH on any antenna port in the same slot if higher layer parameter *CDMType* is configured to *CDM4*.

Resource elements (k, l) used for transmission of CSI reference signals on any of the antenna ports in the set S , where

- $S = \{15,16,19,20,23,24,27,28\}$, $S = \{17,18,21,22,31,32,35,36\}$ or $S = \{25,26,29,30,33,34,37,38\}$ for CSI reference signals on 24 ports, or
- $S = \{15,16,23,24,31,32,39,40\}$, $S = \{17,18,25,26,33,34,41,42\}$, $S = \{19,20,27,28,35,36,43,44\}$ or $S = \{21,22,29,30,37,38,45,46\}$ for CSI reference signals on 32 ports

shall not be used for transmission of PDSCH on any antenna port in the same slot if higher layer parameter *CDMType* is configured to *CDM8*.

The mapping for CSI reference signal configuration 0 is illustrated in Figures 6.10.5.2-1 and 6.10.5.2-2.

Table 6.10.5.2-1: Mapping from CSI reference signal configuration to (k', l') for normal cyclic prefix

CSI-RS config.	Number of CSI reference signals configured		
	1 or 2	4	8

	Normal subframe		Special subframe		Normal subframe		Special subframe		Normal subframe		Special subframe	
	(k',l')	n'_s	(k',l')	n'_s	(k',l')	n'_s	(k',l')	n'_s	(k',l')	n'_s	(k',l')	n'_s
0	(9,5)	0	(9,5)	0	(9,5)	0	(9,5)	0	(9,5)	0	(9,5)	0
1	(11,2)	1	(11,5)	0	(11,2)	1	(11,5)	0	(11,2)	1	(11,5)	0
2	(9,2)	1	(9,2)	1	(9,2)	1	(9,2)	1	(9,2)	1	(9,2)	1
3	(7,2)	1	(7,5)	0	(7,2)	1	(7,5)	0	(7,2)	1	(7,5)	0
4	(9,5)	1			(9,5)	1			(9,5)	1		
5	(8,5)	0	(8,5)	0	(8,5)	0	(8,5)	0				
6	(10,2)	1	(10,5)	0	(10,2)	1	(10,5)	0				
7	(8,2)	1	(8,2)	1	(8,2)	1	(8,2)	1				
8	(6,2)	1	(6,5)	0	(6,2)	1	(6,5)	0				
9	(8,5)	1			(8,5)	1						
10	(3,5)	0	(3,5)	0								
11	(2,5)	0	(2,5)	0								
12	(5,2)	1	(5,5)	0								
13	(4,2)	1	(4,5)	0								
14	(3,2)	1	(3,2)	1								
15	(2,2)	1	(2,2)	1								
16	(1,2)	1	(1,5)	0								
17	(0,2)	1	(0,5)	0								
18	(3,5)	1										
19	(2,5)	1										
20	(11,1)	1			(11,1)	1			(11,1)	1		
21	(9,1)	1			(9,1)	1			(9,1)	1		
22	(7,1)	1			(7,1)	1			(7,1)	1		
23	(10,1)	1			(10,1)	1						
24	(8,1)	1			(8,1)	1						
25	(6,1)	1			(6,1)	1						
26	(5,1)	1										
27	(4,1)	1										
28	(3,1)	1										
29	(2,1)	1										
30	(1,1)	1										
31	(0,1)	1										

Note: $n'_s = n_s \text{ mod } 2$. Configurations 0 – 19 for normal subframes are available for frame structure types 1, 2 and 3. Configurations 20 – 31 and configurations for special subframes are available for frame structure type 2 only.

Table 6.10.5.2-2: Mapping from CSI reference signal configuration to (k', l') for extended cyclic prefix.

CSI-RS config.	Number of CSI reference signals configured											
	1 or 2				4				8			
	Normal subframe		Special subframe		Normal subframe		Special subframe		Normal Subframe		Special subframe	
	(k', l')	n'_s	(k', l')	n'_s	(k', l')	n'_s	(k', l')	n'_s	(k', l')	n'_s	(k', l')	n'_s
0	(11,4)	0	(11,4)	0	(11,4)	0	(11,4)	0	(11,4)	0	(11,4)	0
1	(9,4)	0	(9,4)	0	(9,4)	0	(9,4)	0	(9,4)	0	(9,4)	0
2	(10,4)	1			(10,4)	1			(10,4)	1		
3	(9,4)	1			(9,4)	1			(9,4)	1		
4	(5,4)	0	(5,4)	0	(5,4)	0	(5,4)	0				
5	(3,4)	0	(3,4)	0	(3,4)	0	(3,4)	0				
6	(4,4)	1			(4,4)	1						
7	(3,4)	1			(3,4)	1						
8	(8,4)	0	(8,4)	0								
9	(6,4)	0	(6,4)	0								
10	(2,4)	0	(2,4)	0								
11	(0,4)	0	(0,4)	0								
12	(7,4)	1										
13	(6,4)	1										
14	(1,4)	1										
15	(0,4)	1										
16	(11,1)	1	(11,1)	1	(11,1)	1	(11,1)	1	(11,1)	1	(11,1)	1
17	(10,1)	1	(10,1)	1	(10,1)	1	(10,1)	1	(10,1)	1	(10,1)	1
18	(9,1)	1	(9,1)	1	(9,1)	1	(9,1)	1	(9,1)	1	(9,1)	1
19	(5,1)	1	(5,1)	1	(5,1)	1	(5,1)	1				
20	(4,1)	1	(4,1)	1	(4,1)	1	(4,1)	1				
21	(3,1)	1	(3,1)	1	(3,1)	1	(3,1)	1				
22	(8,1)	1	(8,1)	1								
23	(7,1)	1	(7,1)	1								
24	(6,1)	1	(6,1)	1								
25	(2,1)	1	(2,1)	1								
26	(1,1)	1	(1,1)	1								
27	(0,1)	1	(0,1)	1								

Note: $n'_s = n_s \bmod 2$. Configurations 0 – 15 for normal subframes are available for both frame structure type 1 and type 2. Configurations 16 – 27 and configurations for special subframes are available for frame structure type 2 only.

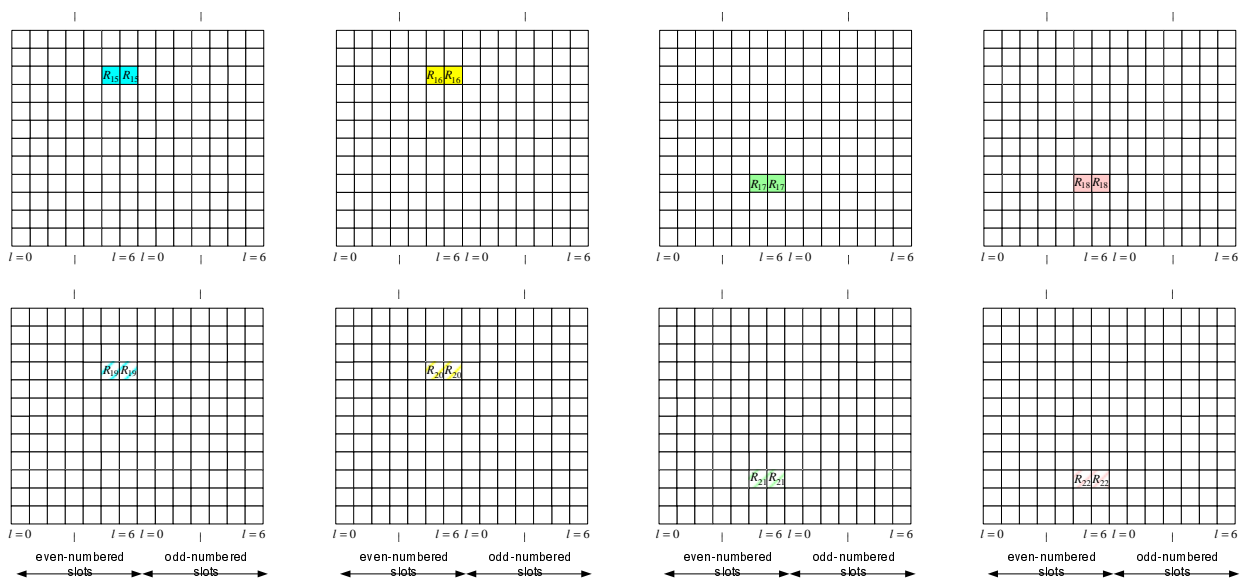

Figure 6.10.5.2-1: Mapping of CSI reference signals (CSI configuration 0, normal cyclic prefix)

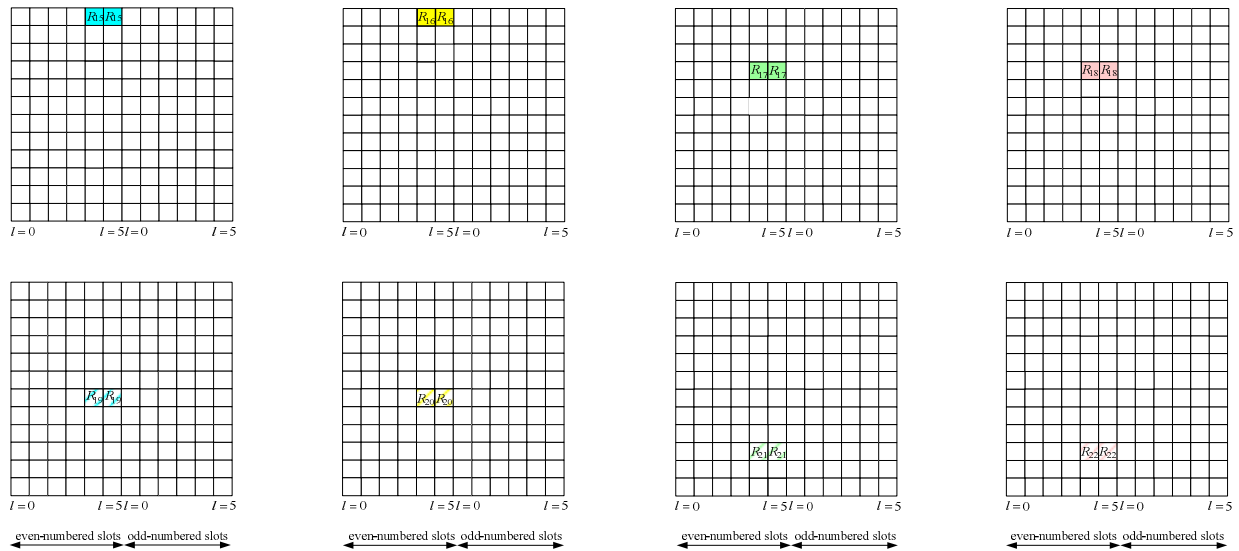

Figure 6.10.5.2-2: Mapping of CSI reference signals (CSI configuration 0, extended cyclic prefix)

6.10.5.3 CSI reference signal subframe configuration

The subframe configuration period $T_{\text{CSI-RS}}$ and the subframe offset $\Delta_{\text{CSI-RS}}$ for the occurrence of CSI reference signals are listed in Table 6.10.5.3-1. The parameter $I_{\text{CSI-RS}}$ can be configured separately for CSI reference signals for which the UE shall assume non-zero and zero transmission power. Subframes containing CSI reference signals that do not correspond to either higher layer configured parameter *csi-RS-ConfigNZP-ApList* or *csi-RS-ConfigZP-ApList* shall satisfy $(10n_f + \lfloor n_s/2 \rfloor - \Delta_{\text{CSI-RS}}) \bmod T_{\text{CSI-RS}} = 0$.

Table 6.10.5.3-1: CSI reference signal subframe configuration

CSI-RS-SubframeConfig $I_{\text{CSI-RS}}$	CSI-RS periodicity $T_{\text{CSI-RS}}$ (subframes)	CSI-RS subframe offset $\Delta_{\text{CSI-RS}}$ (subframes)
0 – 4	5	$I_{\text{CSI-RS}}$
5 – 14	10	$I_{\text{CSI-RS}} - 5$
15 – 34	20	$I_{\text{CSI-RS}} - 15$
35 – 74	40	$I_{\text{CSI-RS}} - 35$
75 – 154	80	$I_{\text{CSI-RS}} - 75$

6.11 Synchronization signals

There are 504 unique physical-layer cell identities. The physical-layer cell identities are grouped into 168 unique physical-layer cell-identity groups, each group containing three unique identities. The grouping is such that each physical-layer cell identity is part of one and only one physical-layer cell-identity group. A physical-layer cell identity $N_{\text{ID}}^{\text{cell}} = 3N_{\text{ID}}^{(1)} + N_{\text{ID}}^{(2)}$ is thus uniquely defined by a number $N_{\text{ID}}^{(1)}$ in the range of 0 to 167, representing the physical-layer cell-identity group, and a number $N_{\text{ID}}^{(2)}$ in the range of 0 to 2, representing the physical-layer identity within the physical-layer cell-identity group.

6.11.1 Primary synchronization signal (PSS)

6.11.1.1 Sequence generation

The sequence $d(n)$ used for the primary synchronization signal is generated from a frequency-domain Zadoff-Chu sequence according to

$$d_u(n) = \begin{cases} e^{-j\frac{\pi n(n+1)}{63}} & n = 0,1,\dots,30 \\ e^{-j\frac{\pi n(n+1)(n+2)}{63}} & n = 31,32,\dots,61 \end{cases}$$

where the Zadoff-Chu root sequence index u is given by Table 6.11.1.1-1.

Table 6.11.1.1-1: Root indices for the primary synchronization signal

$N_{ID}^{(2)}$	Root index u
0	25
1	29
2	34

6.11.1.2 Mapping to resource elements

The mapping of the sequence to resource elements depends on the frame structure. The UE shall not assume that the primary synchronization signal is transmitted on the same antenna port as any of the downlink reference signals. The UE shall not assume that any transmission instance of the primary synchronization signal is transmitted on the same antenna port, or ports, used for any other transmission instance of the primary synchronization signal.

The sequence $d(n)$ shall be mapped to the resource elements according to

$$a_{k,l} = d(n), \quad n = 0, \dots, 61$$

$$k = n - 31 + \frac{N_{RB}^{DL} N_{sc}^{RB}}{2}$$

For frame structure type 1, the primary synchronization signal shall be mapped to the last OFDM symbol in slots 0 and 10.

For frame structure type 2, the primary synchronization signal shall be mapped to the third OFDM symbol in subframes 1 and 6. Resource elements (k, l) in the OFDM symbols used for transmission of the primary synchronization signal where

$$k = n - 31 + \frac{N_{RB}^{DL} N_{sc}^{RB}}{2}$$

$$n = -5, -4, \dots, -1, 62, 63, \dots, 66$$

are reserved and not used for transmission of the primary synchronization signal.

For frame structure type 3, the primary synchronization signal shall be mapped according to frame structure type 1 with the following exceptions:

- the primary synchronization signal shall be transmitted only if the corresponding subframe is non-empty and at least 12 OFDM symbols are transmitted,
- a primary synchronization signal being part of a discovery signal shall be transmitted in the last OFDM symbol of the first slot of a discovery signal occasion.

For an MBMS-dedicated cell, the primary synchronization signal shall be mapped according to frame structure type 1 with following exception:

- the primary synchronization signal shall be transmitted in slot 0 in subframes fulfilling $n_f \bmod 4 = 0$ only,

6.11.2 Secondary synchronization signal (SSS)

6.11.2.1 Sequence generation

The sequence $d(0), \dots, d(61)$ used for the second synchronization signal is an interleaved concatenation of two length-31 binary sequences. The concatenated sequence is scrambled with a scrambling sequence given by the primary synchronization signal.

The combination of two length-31 sequences defining the secondary synchronization signal differs between subframes according to

$$d(2n) = \begin{cases} s_0^{(m_0)}(n)c_0(n) & \text{in subframes 0, 1, 2, 3, 4} \\ s_1^{(m_1)}(n)c_0(n) & \text{in subframes 5, 6, 7, 8, 9} \end{cases}$$

$$d(2n+1) = \begin{cases} s_1^{(m_1)}(n)c_1(n)z_1^{(m_0)}(n) & \text{in subframes 0, 1, 2, 3, 4} \\ s_0^{(m_0)}(n)c_1(n)z_1^{(m_1)}(n) & \text{in subframes 5, 6, 7, 8, 9} \end{cases}$$

where $0 \leq n \leq 30$. The indices m_0 and m_1 are derived from the physical-layer cell-identity group $N_{\text{ID}}^{(1)}$ according to

$$m_0 = m' \bmod 31$$

$$m_1 = (m_0 + \lfloor m'/31 \rfloor + 1) \bmod 31$$

$$m' = N_{\text{ID}}^{(1)} + q(q+1)/2, \quad q = \left\lfloor \frac{N_{\text{ID}}^{(1)} + q'(q'+1)/2}{30} \right\rfloor, \quad q' = \lfloor N_{\text{ID}}^{(1)}/30 \rfloor$$

where the output of the above expression is listed in Table 6.11.2.1-1.

The two sequences $s_0^{(m_0)}(n)$ and $s_1^{(m_1)}(n)$ are defined as two different cyclic shifts of the m-sequence $\tilde{s}(n)$ according to

$$s_0^{(m_0)}(n) = \tilde{s}((n + m_0) \bmod 31)$$

$$s_1^{(m_1)}(n) = \tilde{s}((n + m_1) \bmod 31)$$

where $\tilde{s}(i) = 1 - 2x(i)$, $0 \leq i \leq 30$, is defined by

$$x(\bar{i} + 5) = (x(\bar{i} + 2) + x(\bar{i})) \bmod 2, \quad 0 \leq \bar{i} \leq 25$$

with initial conditions $x(0) = 0$, $x(1) = 0$, $x(2) = 0$, $x(3) = 0$, $x(4) = 1$.

The two scrambling sequences $c_0(n)$ and $c_1(n)$ depend on the primary synchronization signal and are defined by two different cyclic shifts of the m-sequence $\tilde{c}(n)$ according to

$$c_0(n) = \tilde{c}((n + N_{\text{ID}}^{(2)}) \bmod 31)$$

$$c_1(n) = \tilde{c}((n + N_{\text{ID}}^{(2)} + 3) \bmod 31)$$

where $N_{\text{ID}}^{(2)} \in \{0, 1, 2\}$ is the physical-layer identity within the physical-layer cell identity group $N_{\text{ID}}^{(1)}$ and $\tilde{c}(i) = 1 - 2x(i)$, $0 \leq i \leq 30$, is defined by

$$x(\bar{i} + 5) = (x(\bar{i} + 3) + x(\bar{i})) \bmod 2, \quad 0 \leq \bar{i} \leq 25$$

with initial conditions $x(0) = 0$, $x(1) = 0$, $x(2) = 0$, $x(3) = 0$, $x(4) = 1$.

The scrambling sequences $z_1^{(m_0)}(n)$ and $z_1^{(m_1)}(n)$ are defined by a cyclic shift of the m-sequence $\tilde{z}(n)$ according to

$$z_1^{(m_0)}(n) = \tilde{z}((n + (m_0 \bmod 8)) \bmod 31)$$

$$z_1^{(m_1)}(n) = \tilde{z}((n + (m_1 \bmod 8)) \bmod 31)$$

where m_0 and m_1 are obtained from Table 6.11.2.1-1 and $\tilde{z}(i) = 1 - 2x(i)$, $0 \leq i \leq 30$, is defined by

$$x(\bar{i} + 5) = (x(\bar{i} + 4) + x(\bar{i} + 2) + x(\bar{i} + 1) + x(\bar{i})) \bmod 2, \quad 0 \leq \bar{i} \leq 25$$

with initial conditions $x(0) = 0$, $x(1) = 0$, $x(2) = 0$, $x(3) = 0$, $x(4) = 1$.

Table 6.11.2.1-1: Mapping between physical-layer cell-identity group $N_{\text{ID}}^{(1)}$ and the indices m_0 and m_1

$N_{\text{ID}}^{(1)}$	m_0	m_1	$N_{\text{ID}}^{(1)}$	m_0	m_1	$N_{\text{ID}}^{(1)}$	m_0	m_1	$N_{\text{ID}}^{(1)}$	m_0	m_1	$N_{\text{ID}}^{(1)}$	m_0	m_1
0	0	1	34	4	6	68	9	12	102	15	19	136	22	27
1	1	2	35	5	7	69	10	13	103	16	20	137	23	28
2	2	3	36	6	8	70	11	14	104	17	21	138	24	29
3	3	4	37	7	9	71	12	15	105	18	22	139	25	30
4	4	5	38	8	10	72	13	16	106	19	23	140	0	6
5	5	6	39	9	11	73	14	17	107	20	24	141	1	7
6	6	7	40	10	12	74	15	18	108	21	25	142	2	8
7	7	8	41	11	13	75	16	19	109	22	26	143	3	9
8	8	9	42	12	14	76	17	20	110	23	27	144	4	10
9	9	10	43	13	15	77	18	21	111	24	28	145	5	11
10	10	11	44	14	16	78	19	22	112	25	29	146	6	12
11	11	12	45	15	17	79	20	23	113	26	30	147	7	13
12	12	13	46	16	18	80	21	24	114	0	5	148	8	14
13	13	14	47	17	19	81	22	25	115	1	6	149	9	15
14	14	15	48	18	20	82	23	26	116	2	7	150	10	16
15	15	16	49	19	21	83	24	27	117	3	8	151	11	17
16	16	17	50	20	22	84	25	28	118	4	9	152	12	18
17	17	18	51	21	23	85	26	29	119	5	10	153	13	19
18	18	19	52	22	24	86	27	30	120	6	11	154	14	20
19	19	20	53	23	25	87	0	4	121	7	12	155	15	21
20	20	21	54	24	26	88	1	5	122	8	13	156	16	22
21	21	22	55	25	27	89	2	6	123	9	14	157	17	23
22	22	23	56	26	28	90	3	7	124	10	15	158	18	24
23	23	24	57	27	29	91	4	8	125	11	16	159	19	25
24	24	25	58	28	30	92	5	9	126	12	17	160	20	26
25	25	26	59	0	3	93	6	10	127	13	18	161	21	27
26	26	27	60	1	4	94	7	11	128	14	19	162	22	28
27	27	28	61	2	5	95	8	12	129	15	20	163	23	29
28	28	29	62	3	6	96	9	13	130	16	21	164	24	30
29	29	30	63	4	7	97	10	14	131	17	22	165	0	7
30	0	2	64	5	8	98	11	15	132	18	23	166	1	8
31	1	3	65	6	9	99	12	16	133	19	24	167	2	9
32	2	4	66	7	10	100	13	17	134	20	25	-	-	-
33	3	5	67	8	11	101	14	18	135	21	26	-	-	-

6.11.2.2 Mapping to resource elements

The mapping of the sequence to resource elements depends on the frame structure. In a subframe for frame structure type 1 and 3 and in a half-frame for frame structure type 2, the same antenna port as for the primary synchronization signal shall be used for the secondary synchronization signal.

The sequence $d(n)$ shall be mapped to resource elements according to

$$a_{k,l} = d(n), \quad n = 0, \dots, 61$$

$$k = n - 31 + \frac{N_{RB}^{DL} N_{sc}^{RB}}{2}$$

$$l = \begin{cases} N_{symb}^{DL} - 2 & \text{in slots 0 and 10} & \text{for frame structure type 1 except for an MBMS - dedicated cell} \\ N_{symb}^{DL} - 1 & \text{in slots 1 and 11} & \text{for frame structure type 2} \\ N_{symb}^{DL} - 2 & \text{in slots where the PSS is transmitted} & \text{for frame structure type 3} \\ N_{symb}^{DL} - 2 & \text{in slots where the PSS is transmitted} & \text{for an MBMS - dedicated cell} \end{cases}$$

Resource elements (k, l) where

$$k = n - 31 + \frac{N_{RB}^{DL} N_{sc}^{RB}}{2}$$

$$l = \begin{cases} N_{symb}^{DL} - 2 & \text{in slots 0 and 10} & \text{for frame structure type 1 except for an MBMS - dedicated cell} \\ N_{symb}^{DL} - 1 & \text{in slots 1 and 11} & \text{for frame structure type 2} \\ N_{symb}^{DL} - 2 & \text{in slots where the PSS is transmitted} & \text{for frame structure type 3} \\ N_{symb}^{DL} - 2 & \text{in slots where the PSS is transmitted} & \text{for an MBMS - dedicated cell} \end{cases}$$

$$n = -5, -4, \dots, -1, 62, 63, \dots, 66$$

are reserved and not used for transmission of the secondary synchronization signal.

6.11.3 Resynchronization signal (RSS)

6.11.3.1 Sequence generation

The resynchronization signal (RSS) is transmitted in N_{RSS} subframes numbered $i = 0, 1, \dots, N_{RSS} - 1$, where the RSS duration N_{RSS} is configured by higher layers. The sequence $d_i(n)$ used for the i th RSS subframe is generated according to

$$d_i(n) = \frac{1-2c(2n)}{\sqrt{2}} + j b(i) \frac{1-2c(2n+1)}{\sqrt{2}}, \quad n = 0, 1, \dots, 263$$

where the pseudo-random sequence $c(n)$ is defined in clause 7.2. The pseudo-random sequence generator shall be initialised each subframe with $c_{init} = N_{ID}^{cell} + 2^9 u$, where u equals the value of the higher-layer parameter *systemInfoUnchanged-BR-r15* as set in subframe $i = 0$. $b(i)$ is given by Table 6.11.3.1-1.

Table 6.11.3.1-1: Definition of $b(i)$.

N_{RSS}	$b(0), b(1), \dots, b(N_{RSS} - 1)$
8	[1, 1, -1, 1, -1, -1, 1, 1]
16	[1, 1, -1, -1, 1, -1, 1, 1, 1, -1, -1, 1, 1, -1, 1, -1]
32	[-1, -1, 1, 1, -1, 1, 1, -1, 1, -1, -1, -1, 1, 1, -1, -1, 1, -1, 1, -1, 1, -1, 1, 1, -1, -1, 1, -1, 1, -1, 1, -1]
40	[1, -1, -1, 1, -1, -1, 1, 1, 1, -1, 1, -1, 1, 1, -1, -1, 1, -1, -1, 1, -1, -1, 1, 1, 1, -1, -1, 1, -1, 1, 1, -1, -1, 1]

6.11.3.2 Mapping to resource elements

If only one CRS port is configured in a cell, the UE may assume that the same antenna port is used for all subframes in an RSS transmission in the cell. Otherwise, the UE may assume that the same antenna port is used for RSS transmission in absolute subframes $2n$ and $2n + 1$ and $n = 0, 1, \dots$

An RSS is transmitted in N_{RSS} consecutive BL/CE DL subframes, starting in the first BL/CE DL subframe in a radio

frame satisfying

$$(n_f \bmod \frac{P_{\text{RSS}}}{10}) = O_{\text{RSS}}$$

where the RSS periodicity P_{RSS} and the RSS time offset O_{RSS} are configured by higher layers. In frequency domain, the RSS frequency location is assigned to the 24 subcarriers in the physical resource blocks numbers $n_{\text{PRB,RSS}}$ and $n_{\text{PRB,RSS}} + 1$, as configured by higher layers.

In each subframe i used for RSS transmission, the RSS sequence $d_i(n)$ shall be mapped to resource elements (k, l) in sequence, starting with $d_i(0)$ in increasing order of first the index $k = 0, 1, \dots, 2N_{\text{sc}}^{\text{RB}} - 1$, over the 24 assigned subcarriers and then the index $l = 3, 4, \dots, 2N_{\text{symb}}^{\text{DL}} - 1$.

A resource element (k, l) overlapping with resource elements where cell-specific reference signals according to clause 6.10 are transmitted shall not be used for RSS transmission but is counted in the mapping process. Additionally, an RSS subframe is dropped if any RSS PRB pair overlaps with any PRB pair carrying PSS, SSS, PBCH or PDSCH associated with SI-RNTI. In frame structure type 2, those special subframes, indicated as BL/CE DL subframes by higher layer *fdd-DownlinkOrTddSubframeBitmapBR*, are not counted in RSS mapping and are not used for transmission of RSS.

6.11A Discovery signal

A discovery signal occasion for a cell consists of a period with a duration of

- one to five consecutive subframes for frame structure type 1
- two to five consecutive subframes for frame structure type 2
- 12 OFDM symbols within one non-empty subframe for frame structure type 3

where the UE in the downlink subframes may assume presence of a discovery signal consisting of

- cell-specific reference signals on antenna port 0 in all downlink subframes and in DwPTS of all special subframes in the period for frame structure type 1 and 2
- cell specific reference signals on antenna port 0 when higher layer parameters indicate only one configured antenna port for cell specific reference signals for a serving cell using frame structure type 3
- cell specific reference signals on antenna port 0 and antenna port 1 when higher layer parameters indicate at least two configured antenna ports for cell specific reference signals for a serving cell using frame structure type 3
- cell specific reference signals on antenna port 0 and antenna port 1 when higher layer configured parameter *presenceAntennaPort1* is signalled to be 1, for a neighbour cell when using frame structure type 3
- primary synchronization signal in the first subframe of the period for frame structure types 1 and 3 or the second subframe of the period for frame structure type 2,
- secondary synchronization signal in the first subframe of the period, and
- non-zero-power CSI reference signals in zero or more subframes in the period. The configuration of non-zero-power CSI reference signals part of the discovery signal is obtained as described in clause 6.10.5.2

For frame structures 1 and 2 the UE may assume a discovery signal occasion once every *dmtc-Periodicity*.

For frame structure type 3, the UE may assume a discovery signal occasion may occur in any subframe within the discovery signals measurement timing configuration in clause 5.5.2.10 of [9].

For frame structure type 3, simultaneous transmission of a discovery signal and PDSCH/PDCCH/EPDCCH may occur in subframes 0 and 5 only.

For frame structure type 3, the UE may assume that a discovery signal occasion occurs in the first subframe containing a primary synchronization signal, secondary synchronization signal and cell-specific reference signals within the discovery measurement timing configuration in clause 5.5.2.10 of [9].

6.11B MTC wake-up signal (MWUS)

6.11B.1 Sequence generation

The MWUS sequence $w(m)$ in subframe $x=0,1,\dots,M-1$ is defined by

$$w(m) = \theta_{n_f, n_s}(m') e^{-j \frac{\pi u n(n+1)}{131}} e^{j \frac{2\pi g m}{132}}$$

$$m = 0, 1, \dots, 131$$

$$m' = m + 132x$$

$$n = m \bmod 132$$

$$\theta_{n_f, n_s}(m') = \begin{cases} 1 & \text{if } c_{n_f, n_s}(2m') = 0 \text{ and } c_{n_f, n_s}(2m' + 1) = 0 \\ -1 & \text{if } c_{n_f, n_s}(2m') = 0 \text{ and } c_{n_f, n_s}(2m' + 1) = 1 \\ j & \text{if } c_{n_f, n_s}(2m') = 1 \text{ and } c_{n_f, n_s}(2m' + 1) = 0 \\ -j & \text{if } c_{n_f, n_s}(2m') = 1 \text{ and } c_{n_f, n_s}(2m' + 1) = 1 \end{cases}$$

$$u = (N_{\text{ID}}^{\text{cell}} \bmod 126) + 3$$

where M is the actual duration of MWUS as defined in [4]. For a UE not configured with group MWUS, $g = 0$. For a UE configured with group MWUS, $g = 14(N_{\text{group}}^{\text{WUS}} + 1)$ for $0 \leq N_{\text{group}}^{\text{WUS}} \leq 7$, where $N_{\text{group}}^{\text{WUS}}$ is determined by the UE group to which the UE is associated as determined by higher layers [10]. In a resource that is not shared with non-group MWUS, the common MWUS sequence shall be determined by $g = 126$. In a resource that is shared with non-group MWUS, the common MWUS sequence is determined by higher layers [9].

The scrambling sequence $c_{n_f, n_s}(i)$, $i = 0, 1, \dots, 2 \cdot 132M - 1$ is given by clause 7.2, and shall be initialized at the start of the MWUS with

$$c_{\text{init_WUS}} = (N_{\text{ID}}^{\text{cell}} + 1) \left(\left((10n_{f, \text{start_PO}} + \left\lfloor \frac{n_{s, \text{start_PO}}}{2} \right\rfloor) \bmod 2048 + 1 \right) 2^9 + N_{\text{ID}}^{\text{cell}} + N_{\text{ID}}^{\text{resource}} \cdot 2^{29} \right)$$

where $n_{f, \text{start_PO}}$ is the first frame of the first PO to which the MWUS is associated, $n_{s, \text{start_PO}}$ is the first slot of the first PO to which the MWUS is associated and $N_{\text{ID}}^{\text{resource}}$ indicates the group MWUS resource to which the UE is associated. For a UE not configured with group MWUS, $N_{\text{ID}}^{\text{resource}} = 0$, whereas for a UE configured with group MWUS, $N_{\text{ID}}^{\text{resource}}$ is determined by higher layers [10].

6.11B.2 Mapping to resource elements

The same antenna port shall be used for all symbols of the MWUS within a subframe. The UE shall not assume that the MWUS is transmitted on the same antenna port as any of the downlink reference signals or synchronization signals. If only one CRS port is configured by the eNB, the UE may assume the transmission of all MWUS subframes is using the same antenna port; otherwise, the UE may assume the same antenna port is used for MWUS transmission in downlink subframes $w0 + 2n$ and $w0 + 2n + 1$, where $w0$ is the first downlink subframe of the MWUS transmission as specified in [4], and $n=0, 1, \dots$

The MWUS bandwidth is 2 consecutive PRBs, the frequency location of the lowermost PRB with $N_{\text{ID}}^{\text{resource}} = 0$ is signaled by higher layers. For both PRB pairs in the frequency domain, for which MWUS is defined, the MWUS sequence $w(m)$ shall be mapped to resource elements (k, l) in sequence, starting with $w(0)$ in increasing order of first the index $k = 0, 1, \dots, N_{\text{sc}}^{\text{RB}} - 1$, over the 12 assigned subcarriers and then the index $l = 3, 4, \dots, 2N_{\text{sym}}^{\text{DL}} - 1$ in each subframe in which MWUS is transmitted.

The MWUS sequence is mapped to the set of subframes in the actual MWUS duration as defined in [4], where in a subframe in which an MWUS PRB pair overlaps with any PRB pair carrying PSS, SSS, RSS, PBCH or PDSCH associated with SI-RNTI is transmitted, the subframe is counted in the MWUS mapping but not used for transmission of MWUS. In frame structure type 2, those special subframes, indicated as BL/CE DL subframes by higher layer *fdd-DownlinkOrTddSubframeBitmapBR*, are not counted in MWUS mapping and are not used for transmission of MWUS.

A resource element (k, l) overlapping with resource elements where cell-specific reference signals according to clause

6.10 are transmitted shall not be used for MWUS transmission but is counted in the mapping process.

6.12 OFDM baseband signal generation

The time-continuous signal $s_l^{(p)}(t)$ on antenna port p in OFDM symbol l in a downlink slot is defined by

$$s_l^{(p)}(t) = \sum_{k=-\lfloor N_{RB}^{DL} N_{sc}^{RB} / 2 \rfloor}^{-1} a_{k^{(-)},l}^{(p)} \cdot e^{j2\pi k \Delta f (t - N_{CP,l} T_s)} + \sum_{k=1}^{\lfloor N_{RB}^{DL} N_{sc}^{RB} / 2 \rfloor} a_{k^{(+)},l}^{(p)} \cdot e^{j2\pi k \Delta f (t - N_{CP,l} T_s)}$$

for $0 \leq t < (N_{CP,l} + N) \times T_s$ where $k^{(-)} = k + \lfloor N_{RB}^{DL} N_{sc}^{RB} / 2 \rfloor$ and $k^{(+)} = k + \lfloor N_{RB}^{DL} N_{sc}^{RB} / 2 \rfloor - 1$. The variable N equals 2048 for $\Delta f = 15$ kHz subcarrier spacing, 4096 for $\Delta f = 7.5$ kHz subcarrier spacing, 12288 for $\Delta f = 2.5$ kHz, 24576 for $\Delta f = 1.25$ kHz subcarrier spacing, and 41472 for $\Delta f = 1 / (82944 T_s) \approx 0.37$ kHz.

For frame structure type 3, if PDCCH is to be transmitted in a subframe starting with OFDM symbol $s_0^{(p)}(t)$ based on the received uplink control information that indicates channel occupancy time sharing ‘1’ as specified in [11], OFDM symbol $s_l^{(p)}(t), l = 13$ in the previous subframe may be transmitted, given by

$$s_{13}^{(p)}(t) = \begin{cases} 0 & 0 \leq t < 768 T_s \\ s_0^{(p)}(t - N_{CP,13} T_s) & 768 T_s \leq t < (N_{CP,13} + N) T_s \end{cases}$$

The OFDM symbols in a slot shall be transmitted in increasing order of l , starting with $l = 0$, where OFDM symbol $l > 0$ starts at time $\sum_{l'=0}^{l-1} (N_{CP,l'} + N) T_s$ within the slot. In case the first OFDM symbol(s) in a slot use normal cyclic prefix and the remaining OFDM symbols use extended cyclic prefix, the starting position the OFDM symbols with extended cyclic prefix shall be identical to those in a slot where all OFDM symbols use extended cyclic prefix. Thus there will be a part of the time slot between the two cyclic prefix regions where the transmitted signal is not specified. For $\Delta f = 1.25$ kHz, there is one OFDM symbol per slot and one slot per subframe.

Table 6.12-1 lists the value of $N_{CP,l}$ that shall be used. Note that different OFDM symbols within a slot in some cases have different cyclic prefix lengths.

In case NB-IoT is supported, the OFDM baseband signal generation is defined in clause 10.2.8.

Table 6.12-1: OFDM parameters

Configuration		Cyclic prefix length $N_{CP,l}$
Normal cyclic prefix	$\Delta f = 15$ kHz	160 for $l = 0$ 144 for $l = 1, 2, \dots, 6$
	$\Delta f = 15$ kHz	512 for $l = 0, 1, \dots, 5$
Extended cyclic prefix	$\Delta f = 7.5$ kHz	1024 for $l = 0, 1, 2$
	$\Delta f = 2.5$ kHz	3072 for $l = 0, 1$
	$\Delta f = 1.25$ kHz	6144 for $l = 0$
	$\Delta f \approx 0.37$ kHz	9216 for $l = 0$

6.13 Modulation and upconversion

Modulation and upconversion to the carrier frequency of the complex-valued OFDM baseband signal for each antenna port is shown in Figure 6.13-1. The filtering required prior to transmission is defined by the requirements in 3GPP TS 36.104 [6].

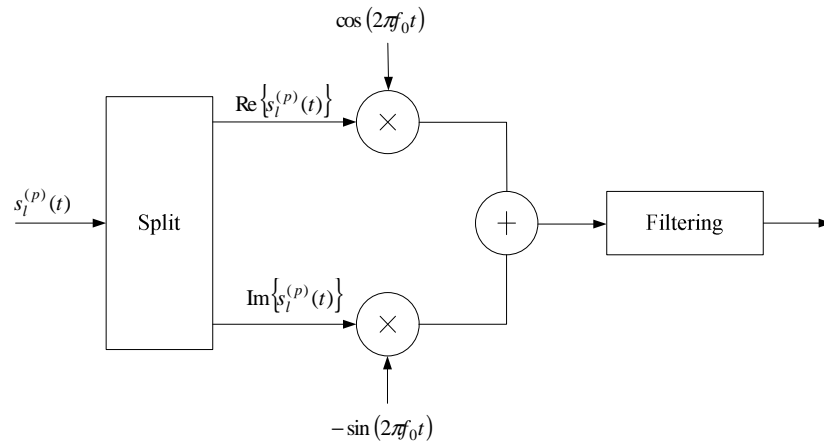
**Figure 6.13-1: Downlink modulation**

7 Generic functions

7.1 Modulation mapper

The modulation mapper takes binary digits, 0 or 1, as input and produces complex-valued modulation symbols, x as output.

7.1.1 BPSK

In case of BPSK modulation, a single bit, $b(i)$, is mapped to a complex-valued modulation symbol $x=I+jQ$ according to Table 7.1.1-1.

Table 7.1.1-1: BPSK modulation mapping

$b(i)$	I	Q
0	$1/\sqrt{2}$	$1/\sqrt{2}$
1	$-1/\sqrt{2}$	$-1/\sqrt{2}$

7.1.2 QPSK

In case of QPSK modulation, pairs of bits, $b(i), b(i+1)$, are mapped to complex-valued modulation symbols x according to Table 7.1.2-1 where $x = I + jQ$ unless "MUST interference presence and power ratio (*MUSTIdx*)" is signalled in the associated DCI and is not '00' in which case $x = e^{j\phi_0\pi}c(I-d) + e^{j(\phi_0+1/2)\pi}c(Q-d)$ where c and d are determined from *MUSTIdx* using Table 7.1.2-2, and each $\phi_0, \phi_1 \in \{0,1\}$ is selected by eNB independently of $b(i), b(i+1)$.

Table 7.1.2-1: QPSK modulation mapping

$b(i), b(i+1)$	I	Q
00	$1/\sqrt{2}$	$1/\sqrt{2}$
01	$1/\sqrt{2}$	$-1/\sqrt{2}$
10	$-1/\sqrt{2}$	$1/\sqrt{2}$
11	$-1/\sqrt{2}$	$-1/\sqrt{2}$

Table 7.1.2-2: Values for c and d for QPSK

<i>MUSTIdx</i>	c	d
01	$\sqrt{1/5}$	$\sqrt{2}$
10	$2/\sqrt{29}$	$5/(2\sqrt{2})$
11	$7\sqrt{1/578}$	$23/(7\sqrt{2})$

7.1.3 16QAM

In case of 16QAM modulation, quadruplets of bits, $b(i), b(i+1), b(i+2), b(i+3)$, are mapped to complex-valued modulation symbols x according to Table 7.1.3-1 where $x = I + jQ$ unless "MUST interference presence and power ratio (*MUSTIdx*)" is signalled in the associated DCI and is not '00' in which case $x = e^{j\phi_0\pi}c(I-d) + e^{j(\phi_0+1/2)\pi}c(Q-d)$

where c and d are determined from $MUSTIdx$ using Table 7.1.3-2, and each $\phi_0, \phi_1 \in \{0,1\}$ is selected by eNB independently of $b(i), b(i+1), b(i+2), b(i+3)$.

Table 7.1.3-1: 16QAM modulation mapping

$b(i), b(i+1), b(i+2), b(i+3)$	I	Q
0000	$1/\sqrt{10}$	$1/\sqrt{10}$
0001	$1/\sqrt{10}$	$3/\sqrt{10}$
0010	$3/\sqrt{10}$	$1/\sqrt{10}$
0011	$3/\sqrt{10}$	$3/\sqrt{10}$
0100	$1/\sqrt{10}$	$-1/\sqrt{10}$
0101	$1/\sqrt{10}$	$-3/\sqrt{10}$
0110	$3/\sqrt{10}$	$-1/\sqrt{10}$
0111	$3/\sqrt{10}$	$-3/\sqrt{10}$
1000	$-1/\sqrt{10}$	$1/\sqrt{10}$
1001	$-1/\sqrt{10}$	$3/\sqrt{10}$
1010	$-3/\sqrt{10}$	$1/\sqrt{10}$
1011	$-3/\sqrt{10}$	$3/\sqrt{10}$
1100	$-1/\sqrt{10}$	$-1/\sqrt{10}$
1101	$-1/\sqrt{10}$	$-3/\sqrt{10}$
1110	$-3/\sqrt{10}$	$-1/\sqrt{10}$
1111	$-3/\sqrt{10}$	$-3/\sqrt{10}$

Table 7.1.3-2: Values for c and d for 16QAM

$MUSTIdx$	c	d
01	$\sqrt{5/21}$	$2\sqrt{2/5}$
10	$3\sqrt{5/334}$	$17/(3\sqrt{10})$
11	$\sqrt{5/69}$	$4\sqrt{2/5}$

7.1.4 64QAM

In case of 64QAM modulation, hexuplets of bits, $b(i), b(i+1), b(i+2), b(i+3), b(i+4), b(i+5)$, are mapped to complex-valued modulation symbols x according to Table 7.1.4-1 where $x = I + jQ$ unless "MUST interference presence and power ratio ($MUSTIdx$)" is signalled in the associated DCI and is not '00' in which case

$x = e^{j\phi_0\pi}c(I-d) + e^{j(\phi_0+1/2)\pi}c(Q-d)$ where c and d are determined from $MUSTIdx$ using Table 7.1.4-2, and each $\phi_0, \phi_1 \in \{0,1\}$ is selected by eNB independently of $b(i), b(i+1), b(i+2), b(i+3), b(i+4), b(i+5)$.

Table 7.1.4-1: 64QAM modulation mapping

$b(i), b(i+1), b(i+2), b(i+3), b(i+4), b(i+5)$	I	Q	$b(i), b(i+1), b(i+2), b(i+3), b(i+4), b(i+5)$	I	Q
000000	$3/\sqrt{42}$	$3/\sqrt{42}$	100000	$-3/\sqrt{42}$	$3/\sqrt{42}$
000001	$3/\sqrt{42}$	$1/\sqrt{42}$	100001	$-3/\sqrt{42}$	$1/\sqrt{42}$

000010	$1/\sqrt{42}$	$3/\sqrt{42}$	100010	$-1/\sqrt{42}$	$3/\sqrt{42}$
000011	$1/\sqrt{42}$	$1/\sqrt{42}$	100011	$-1/\sqrt{42}$	$1/\sqrt{42}$
000100	$3/\sqrt{42}$	$5/\sqrt{42}$	100100	$-3/\sqrt{42}$	$5/\sqrt{42}$
000101	$3/\sqrt{42}$	$7/\sqrt{42}$	100101	$-3/\sqrt{42}$	$7/\sqrt{42}$
000110	$1/\sqrt{42}$	$5/\sqrt{42}$	100110	$-1/\sqrt{42}$	$5/\sqrt{42}$
000111	$1/\sqrt{42}$	$7/\sqrt{42}$	100111	$-1/\sqrt{42}$	$7/\sqrt{42}$
001000	$5/\sqrt{42}$	$3/\sqrt{42}$	101000	$-5/\sqrt{42}$	$3/\sqrt{42}$
001001	$5/\sqrt{42}$	$1/\sqrt{42}$	101001	$-5/\sqrt{42}$	$1/\sqrt{42}$
001010	$7/\sqrt{42}$	$3/\sqrt{42}$	101010	$-7/\sqrt{42}$	$3/\sqrt{42}$
001011	$7/\sqrt{42}$	$1/\sqrt{42}$	101011	$-7/\sqrt{42}$	$1/\sqrt{42}$
001100	$5/\sqrt{42}$	$5/\sqrt{42}$	101100	$-5/\sqrt{42}$	$5/\sqrt{42}$
001101	$5/\sqrt{42}$	$7/\sqrt{42}$	101101	$-5/\sqrt{42}$	$7/\sqrt{42}$
001110	$7/\sqrt{42}$	$5/\sqrt{42}$	101110	$-7/\sqrt{42}$	$5/\sqrt{42}$
001111	$7/\sqrt{42}$	$7/\sqrt{42}$	101111	$-7/\sqrt{42}$	$7/\sqrt{42}$
010000	$3/\sqrt{42}$	$-3/\sqrt{42}$	110000	$-3/\sqrt{42}$	$-3/\sqrt{42}$
010001	$3/\sqrt{42}$	$-1/\sqrt{42}$	110001	$-3/\sqrt{42}$	$-1/\sqrt{42}$
010010	$1/\sqrt{42}$	$-3/\sqrt{42}$	110010	$-1/\sqrt{42}$	$-3/\sqrt{42}$
010011	$1/\sqrt{42}$	$-1/\sqrt{42}$	110011	$-1/\sqrt{42}$	$-1/\sqrt{42}$
010100	$3/\sqrt{42}$	$-5/\sqrt{42}$	110100	$-3/\sqrt{42}$	$-5/\sqrt{42}$
010101	$3/\sqrt{42}$	$-7/\sqrt{42}$	110101	$-3/\sqrt{42}$	$-7/\sqrt{42}$
010110	$1/\sqrt{42}$	$-5/\sqrt{42}$	110110	$-1/\sqrt{42}$	$-5/\sqrt{42}$
010111	$1/\sqrt{42}$	$-7/\sqrt{42}$	110111	$-1/\sqrt{42}$	$-7/\sqrt{42}$
011000	$5/\sqrt{42}$	$-3/\sqrt{42}$	111000	$-5/\sqrt{42}$	$-3/\sqrt{42}$
011001	$5/\sqrt{42}$	$-1/\sqrt{42}$	111001	$-5/\sqrt{42}$	$-1/\sqrt{42}$
011010	$7/\sqrt{42}$	$-3/\sqrt{42}$	111010	$-7/\sqrt{42}$	$-3/\sqrt{42}$
011011	$7/\sqrt{42}$	$-1/\sqrt{42}$	111011	$-7/\sqrt{42}$	$-1/\sqrt{42}$
011100	$5/\sqrt{42}$	$-5/\sqrt{42}$	111100	$-5/\sqrt{42}$	$-5/\sqrt{42}$
011101	$5/\sqrt{42}$	$-7/\sqrt{42}$	111101	$-5/\sqrt{42}$	$-7/\sqrt{42}$
011110	$7/\sqrt{42}$	$-5/\sqrt{42}$	111110	$-7/\sqrt{42}$	$-5/\sqrt{42}$
011111	$7/\sqrt{42}$	$-7/\sqrt{42}$	111111	$-7/\sqrt{42}$	$-7/\sqrt{42}$

Table 7.1.4-2: Values for c and d for 64QAM

<i>MUSTIdx</i>	c	d
01	$\sqrt{21/85}$	$4\sqrt{2/21}$
10	$\sqrt{7/34}$	$3\sqrt{3/14}$
11	$\sqrt{7/55}$	$2\sqrt{6/7}$

7.1.5 256QAM

In case of 256QAM modulation, octuplets of bits, $b(i), b(i+1), b(i+2), b(i+3), b(i+4), b(i+5), b(i+6), b(i+7)$, are mapped to complex-valued modulation symbols $x = (I + jQ)/\sqrt{170}$ according to Table 7.1.5-1.

Table 7.1.5-1: 256QAM modulation mapping

$b(i), \dots, b(i+7)$	I	Q	$b(i), \dots, b(i+7)$	I	Q	$b(i), \dots, b(i+7)$	I	Q	$b(i), \dots, b(i+7)$	I	Q
00000000	5	5	01000000	5	-5	10000000	-5	5	11000000	-5	-5
00000001	5	7	01000001	5	-7	10000001	-5	7	11000001	-5	-7
00000010	7	5	01000010	7	-5	10000010	-7	5	11000010	-7	-5
00000011	7	7	01000011	7	-7	10000011	-7	7	11000011	-7	-7
00000100	5	3	01000100	5	-3	10000100	-5	3	11000100	-5	-3
00000101	5	1	01000101	5	-1	10000101	-5	1	11000101	-5	-1
00000110	7	3	01000110	7	-3	10000110	-7	3	11000110	-7	-3
00000111	7	1	01000111	7	-1	10000111	-7	1	11000111	-7	-1
00001000	3	5	01001000	3	-5	10001000	-3	5	11001000	-3	-5
00001001	3	7	01001001	3	-7	10001001	-3	7	11001001	-3	-7
00001010	1	5	01001010	1	-5	10001010	-1	5	11001010	-1	-5
00001011	1	7	01001011	1	-7	10001011	-1	7	11001011	-1	-7
00001100	3	3	01001100	3	-3	10001100	-3	3	11001100	-3	-3
00001101	3	1	01001101	3	-1	10001101	-3	1	11001101	-3	-1
00001110	1	3	01001110	1	-3	10001110	-1	3	11001110	-1	-3
00001111	1	1	01001111	1	-1	10001111	-1	1	11001111	-1	-1
00010000	5	11	01010000	5	-11	10010000	-5	11	11010000	-5	-11
00010001	5	9	01010001	5	-9	10010001	-5	9	11010001	-5	-9
00010010	7	11	01010010	7	-11	10010010	-7	11	11010010	-7	-11
00010011	7	9	01010011	7	-9	10010011	-7	9	11010011	-7	-9
00010100	5	13	01010100	5	-13	10010100	-5	13	11010100	-5	-13
00010101	5	15	01010101	5	-15	10010101	-5	15	11010101	-5	-15
00010110	7	13	01010110	7	-13	10010110	-7	13	11010110	-7	-13
00010111	7	15	01010111	7	-15	10010111	-7	15	11010111	-7	-15
00011000	3	11	01011000	3	-11	10011000	-3	11	11011000	-3	-11
00011001	3	9	01011001	3	-9	10011001	-3	9	11011001	-3	-9
00011010	1	11	01011010	1	-11	10011010	-1	11	11011010	-1	-11
00011011	1	9	01011011	1	-9	10011011	-1	9	11011011	-1	-9
00011100	3	13	01011100	3	-13	10011100	-3	13	11011100	-3	-13
00011101	3	15	01011101	3	-15	10011101	-3	15	11011101	-3	-15
00011110	1	13	01011110	1	-13	10011110	-1	13	11011110	-1	-13
00011111	1	15	01011111	1	-15	10011111	-1	15	11011111	-1	-15
00100000	11	5	01100000	11	-5	10100000	-11	5	11100000	-11	-5
00100001	11	7	01100001	11	-7	10100001	-11	7	11100001	-11	-7
00100010	9	5	01100010	9	-5	10100010	-9	5	11100010	-9	-5
00100011	9	7	01100011	9	-7	10100011	-9	7	11100011	-9	-7
00100100	11	3	01100100	11	-3	10100100	-11	3	11100100	-11	-3
00100101	11	1	01100101	11	-1	10100101	-11	1	11100101	-11	-1
00100110	9	3	01100110	9	-3	10100110	-9	3	11100110	-9	-3
00100111	9	1	01100111	9	-1	10100111	-9	1	11100111	-9	-1
00101000	13	5	01101000	13	-5	10101000	-13	5	11101000	-13	-5
00101001	13	7	01101001	13	-7	10101001	-13	7	11101001	-13	-7
00101010	15	5	01101010	15	-5	10101010	-15	5	11101010	-15	-5
00101011	15	7	01101011	15	-7	10101011	-15	7	11101011	-15	-7
00101100	13	3	01101100	13	-3	10101100	-13	3	11101100	-13	-3
00101101	13	1	01101101	13	-1	10101101	-13	1	11101101	-13	-1
00101110	15	3	01101110	15	-3	10101110	-15	3	11101110	-15	-3
00101111	15	1	01101111	15	-1	10101111	-15	1	11101111	-15	-1
00110000	11	11	01110000	11	-11	10110000	-11	11	11110000	-11	-11
00110001	11	9	01110001	11	-9	10110001	-11	9	11110001	-11	-9
00110010	9	11	01110010	9	-11	10110010	-9	11	11110010	-9	-11
00110011	9	9	01110011	9	-9	10110011	-9	9	11110011	-9	-9
00110100	11	13	01110100	11	-13	10110100	-11	13	11110100	-11	-13
00110101	11	15	01110101	11	-15	10110101	-11	15	11110101	-11	-15
00110110	9	13	01110110	9	-13	10110110	-9	13	11110110	-9	-13
00110111	9	15	01110111	9	-15	10110111	-9	15	11110111	-9	-15

00111000	13	11	01111000	13	-11	10111000	-13	11	11111000	-13	-11
00111001	13	9	01111001	13	-9	10111001	-13	9	11111001	-13	-9
00111010	15	11	01111010	15	-11	10111010	-15	11	11111010	-15	-11
00111011	15	9	01111011	15	-9	10111011	-15	9	11111011	-15	-9
00111100	13	13	01111100	13	-13	10111100	-13	13	11111100	-13	-13
00111101	13	15	01111101	13	-15	10111101	-13	15	11111101	-13	-15
00111110	15	13	01111110	15	-13	10111110	-15	13	11111110	-15	-13
00111111	15	15	01111111	15	-15	10111111	-15	15	11111111	-15	-15

7.1.6 1024QAM

In case of 1024QAM modulation, 10-tuplets of bits,

$b(i), b(i+1), b(i+2), b(i+3), b(i+4), b(i+5), b(i+6), b(i+7), b(i+8), b(i+9)$, are mapped to complex-valued modulation symbols x according to

$$x = \frac{1}{\sqrt{682}} \left\{ (1-2b(i)) \left[16 - (1-2b(i+2)) \left[8 - (1-2b(i+4)) \left[4 - (1-2b(i+6)) \left[2 - (1-2b(i+8)) \right] \right] \right] \right] \right. \\ \left. + j(1-2b(i+1)) \left[16 - (1-2b(i+3)) \left[8 - (1-2b(i+5)) \left[4 - (1-2b(i+7)) \left[2 - (1-2b(i+9)) \right] \right] \right] \right] \right\}$$

7.2 Pseudo-random sequence generation

Pseudo-random sequences are defined by a length-31 Gold sequence. The output sequence $c(n)$ of length M_{PN} , where $n = 0, 1, \dots, M_{PN} - 1$, is defined by

$$c(n) = (x_1(n + N_C) + x_2(n + N_C)) \bmod 2 \\ x_1(n + 31) = (x_1(n + 3) + x_1(n)) \bmod 2 \\ x_2(n + 31) = (x_2(n + 3) + x_2(n + 2) + x_2(n + 1) + x_2(n)) \bmod 2$$

where $N_C = 1600$ and the first m-sequence shall be initialized with $x_1(0) = 1, x_1(n) = 0, n = 1, 2, \dots, 30$. The initialization

of the second m-sequence is denoted by $c_{\text{init}} = \sum_{i=0}^{30} x_2(i) \cdot 2^i$ with the value depending on the application of the sequence.

8 Timing

8.1 Uplink-downlink frame timing

Transmission of the uplink radio frame number i from the UE shall start $(N_{TA} + N_{TA \text{ offset}}) \times T_s$ seconds before the start of the corresponding downlink radio frame at the UE.

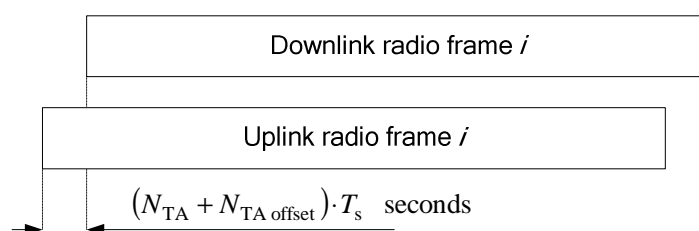

Figure 8.1-1: Uplink-downlink timing relation

Except for the cases mentioned in Table 8.1-1, Table 8.1-2 and Table 8.1-3, the range of N_{TA} is: $0 \leq N_{TA} \leq 20512$.

For frame structure type 1 $N_{TA\text{ offset}} = 0$ and for frame structure type 2 $N_{TA\text{ offset}} = 624$ unless stated otherwise in [4]. Note that not all slots in a radio frame may be transmitted. One example hereof is TDD, where only a subset of the slots in a radio frame is transmitted.

N_{TA} is defined in different ranges depending on the UE configuration according to Table 8.1-1, Table 8.1-2 and Table 8.1-3. In case of subslot based transmission (Table 8.1-2 and Table 8.1-3), the UE is configured by higher layer signalling a processing timeline and an associated range of timing advance.

Table 8.1-1: Ranges of N_{TA} for a UE configured with SCG, short processing time or slot-based transmission in both DL and UL

Range of N_{TA}	Condition
$0 \leq N_{TA} \leq 4096$	if the UE is configured with a SCG
$0 \leq N_{TA} \leq 6144$	if the UE is configured with <i>shortProcessingTime</i> (see 3GPP TS 36.331 [9])
$0 \leq N_{TA} \leq 9520$	if the UE is configured with <i>dl-STTI-Length</i> and <i>ul-STTI-Length</i> (see 3GPP TS 36.331 [9]) set to 'slot' for the serving cell

Table 8.1-2: Ranges of N_{TA} for a UE configured with subslot-based transmission in both DL and UL (*dl-STTI-Length* and *ul-STTI-Length*, see 3GPP TS 36.331 [9], set to 'subslot')

Range of N_{TA}	proc-Timeline
$0 \leq N_{TA} \leq 2048$	nplus4set1
$0 \leq N_{TA} \leq 10816$	nplus6set1
$0 \leq N_{TA} \leq 5120$	nplus6set2
$0 \leq N_{TA} \leq 13888$	nplus8set2
NOTE 1: See 3GPP TS 36.331 [9]	

Table 8.1-3: Ranges of N_{TA} for a UE configured with subslot-based transmission in DL and slot-based transmission in UL (*dl-STTI-Length* and *ul-STTI-Length*, see 3GPP TS 36.331 [9], set to 'subslot' and 'slot', respectively)

Range of N_{TA}	proc-Timeline
$0 \leq N_{TA} \leq 2048$	nplus4set1
$0 \leq N_{TA} \leq 9520$	nplus6set1
$0 \leq N_{TA} \leq 5120$	nplus6set2
$0 \leq N_{TA} \leq 9520$	nplus8set2
NOTE 1: See 3GPP TS 36.331 [9]	

In all other cases the range of N_{TA} is: $0 \leq N_{TA} \leq 20512$.

9 Sidelink

9.1 Overview

A sidelink is used for ProSe direct communication and ProSe direct discovery between UEs.

9.1.1 Physical channels

A sidelink physical channel corresponds to a set of resource elements carrying information originating from higher layers and is the interface defined between 3GPP TS 36.212 [3] and the present document 3GPP TS 36.211. The following sidelink physical channels are defined:

- Physical Sidelink Shared Channel, PSSCH
- Physical Sidelink Control Channel, PSCCH
- Physical Sidelink Discovery Channel, PSDCH
- Physical Sidelink Broadcast Channel, PSBCH

Generation of the baseband signal representing the different physical sidelink channels is illustrated in Figure 5.3-1.

9.1.2 Physical signals

A sidelink physical signal is used by the physical layer but does not carry information originating from higher layers. The following sidelink physical signals are defined:

- Demodulation reference signal
- Synchronization signal

9.1.3 Handling of simultaneous sidelink and uplink/downlink transmissions

For a given frequency, on an uplink subframe included in *discTxGapConfig* [9], a UE shall not transmit an uplink transmission that is not a PRACH transmission and that is partly or completely overlapping in time with a PSDCH transmission or a SLSS transmission for PSDCH by the same UE. Else, for a given carrier frequency and sidelink transmission mode 1 or 2 or sidelink discovery, a UE shall not transmit a sidelink signal or channel overlapping partly or completely in time with an uplink transmission from the same UE.

For a given carrier frequency, no PSDCH, PSCCH, or PSSCH transmission shall occur from a UE in a sidelink subframe configured for synchronization purposes by the higher-layer parameters

- *syncOffsetIndicator1* or *syncOffsetIndicator2* in [9] if the UE has no serving cell fulfilling the S criterion according to [10, clause 5.2.3.2], or
- *syncOffsetIndicator* in *commSyncConfig* or *discSyncConfig* which includes *txParameters* in [9] if the UE has a serving cell fulfilling the S criterion according to [10, clause 5.2.3.2]. The UE may assume the same configuration in *commSyncConfig* and *discSyncConfig*.

For a given carrier frequency, with the exception of PSSCH transmissions with transmission mode 1 and same sidelink cyclic prefix as PUSCH, no sidelink transmissions shall occur in sidelink subframe n from a UE if uplink SRS is transmitted from the same UE in uplink subframe n .

A UE with limited transmission capabilities, on an uplink subframe included in *discTxGapConfig* [9], shall first prioritize a PSDCH transmission or a SLSS transmission for PSDCH over an uplink transmission that is not a PRACH transmission. Else, a UE with limited transmission capabilities shall at a given time first prioritize uplink transmissions, followed by sidelink transmission mode 1 or 2 or sidelink discovery.

A UE with limited transmission capabilities shall at a given time prioritize sidelink communication transmissions (PSSS, SSSS, PSBCH, PSSCH, PSCCH) over sidelink discovery transmissions (PSDCH).

A UE with limited reception capabilities, on a downlink subframe included in *discRxGapConfig* [9], shall first prioritize reception of PSDCH or reception of SLSS for PSDCH over downlink reception. Else, a UE with limited reception capabilities shall at a given time first prioritize downlink reception over sidelink reception.

A UE with limited reception capabilities shall at a given time first prioritize sidelink communication reception, sidelink discovery reception on carriers configured by the eNodeB, and last sidelink discovery reception on carriers not configured by the eNodeB.

9.2 Slot structure and physical resources

Sidelink transmissions are organized into radio frames with a duration of T_f , each consisting of 20 slots of duration T_{slot} . A sidelink subframe consists of two consecutive slots, starting with an even-numbered slot.

9.2.1 Resource grid

A transmitted physical channel or signal in a slot is described by a resource grid of $N_{\text{RB}}^{\text{SL}} N_{\text{sc}}^{\text{RB}}$ subcarriers and $N_{\text{symb}}^{\text{SL}}$ SC-FDMA symbols. The sidelink bandwidth $N_{\text{RB}}^{\text{SL}} = N_{\text{RB}}^{\text{UL}}$ if the S criterion according to [10, clause 5.2.3.2] is fulfilled for a serving cell having the same uplink carrier frequency as the sidelink, otherwise a preconfigured value is used [9].

The sidelink cyclic prefix is configured independently for type 1 discovery, type 2B discovery, sidelink transmission mode 1, sidelink transmission mode 2, control signalling, and PSBCH and synchronization signals. Configuration is per resource pool for discovery, sidelink transmission mode 2, and control signalling. The PSBCH and synchronization signals always use the same cyclic prefix.

Only normal cyclic prefix is supported for PSSCH, PSCCH, PSBCH, and synchronization signals for a sidelink configured with transmission mode 3 or 4.

The resource grid is illustrated in Figure 5.2.1-1.

An antenna port is defined such that the channel over which a symbol on the antenna port is conveyed can be inferred from the channel over which another symbol on the same antenna port is conveyed. There is one resource grid per antenna port. The antenna ports used for transmission of a physical channel or signal are shown in Table 9.2.1-1.

Table 9.2.1-1: Antenna ports used for different physical channels and signals

Physical channel or signal	Antenna port number
PSSCH	1000
PSCCH	1000
PSDCH	1000
PSBCH	1010
Synchronization signals	1020

9.2.2 Resource elements

Each element in the resource grid is called a resource element and is uniquely defined by the index pair (k, l) in a slot where $k = 0, \dots, N_{\text{RB}}^{\text{SL}} N_{\text{sc}}^{\text{RB}} - 1$ and $l = 0, \dots, N_{\text{symb}}^{\text{SL}} - 1$ are the indices in the frequency and time domains, respectively.

Resource element (k, l) on antenna port p corresponds to the complex value $a_{k,l}^{(p)}$. When there is no risk for confusion, or no particular antenna port is specified, the index p may be dropped.

Quantities $a_{k,l}^{(p)}$ corresponding to resource elements not used for transmission of a physical channel or a physical signal in a slot shall be set to zero.

9.2.3 Resource blocks

A physical resource block is defined as $N_{\text{symb}}^{\text{SL}}$ consecutive SC-FDMA symbols in the time domain and $N_{\text{sc}}^{\text{RB}}$ consecutive subcarriers in the frequency domain, where $N_{\text{symb}}^{\text{SL}}$ and $N_{\text{sc}}^{\text{RB}}$ are given by Table 9.2.3-1. A physical resource block in the sidelink thus consists of $N_{\text{symb}}^{\text{SL}} \times N_{\text{sc}}^{\text{RB}}$ resource elements, corresponding to one slot in the time domain and 180 kHz in the frequency domain.

Table 9.2.3-1: Resource block parameters

Configuration	$N_{\text{sc}}^{\text{RB}}$	$N_{\text{symb}}^{\text{SL}}$
Normal cyclic prefix	12	7
Extended cyclic prefix	12	6

The relation between the physical resource block number n_{PRB} in the frequency domain and resource elements (k, l) in a slot is given by

$$n_{\text{PRB}} = \left\lfloor \frac{k}{N_{\text{sc}}^{\text{RB}}} \right\rfloor$$

9.2.4 Resource pool

The subframe pools and resource block pools are defined in [4].

For PSSCH, the number of the current slot in the subframe pool $n_{\text{ss}}^{\text{PSSCH}} = 2n_{\text{ssf}}^{\text{PSSCH}} + i$, where $i \in \{0,1\}$ is the number of the current slot within the current sidelink subframe $n_{\text{ssf}}^{\text{PSSCH}} = j \bmod 10$ with j equal to the subscript of l_j^{PSSCH} , defined in clauses 14.1.4 and 14.2.3 of [4] for sidelink transmission modes 1 and 2, respectively; and where $i \in \{0,1\}$ is the number of the current slot within the current sidelink subframe $n_{\text{ssf}}^{\text{PSSCH}} = k \bmod 10$ with k equal to the subscript of t_k^{SL} , defined in clauses 14.1.1.5 of [4] for sidelink transmission modes 3 and 4.

9.2.5 Guard period

The last SC-FDMA symbol in a sidelink subframe serves as a guard period and shall not be used for sidelink transmission.

9.3 Physical Sidelink Shared Channel

9.3.1 Scrambling

The block of bits $b(0), \dots, b(M_{\text{bit}} - 1)$, where M_{bit} is the number of bits transmitted on the physical sidelink shared channel in one subframe shall be scrambled according to clause 5.3.1.

The scrambling sequence generator shall be initialised with $c_{\text{init}} = n_{\text{ID}}^{\text{X}} \cdot 2^{14} + n_{\text{ssf}}^{\text{PSSCH}} \cdot 2^9 + 510$ at the start of every PSSCH subframe where

- for sidelink transmission modes 1 and 2, $n_{\text{ID}}^{\text{X}} = n_{\text{ID}}^{\text{SA}}$ is destination identity obtained from the sidelink control channel, and
- for sidelink transmission modes 3 and 4, $n_{\text{ID}}^{\text{X}} = \sum_{i=0}^{L-1} p_i \cdot 2^{L-1-i}$ with p and L given by clause 5.1.1 in [3] equals the decimal representation of CRC on the PSSCH transmitted in the same subframe as the PSSCH.

9.3.2 Modulation

Modulation shall be done according to clause 5.3.2. Table 9.3.2-1 specifies the modulation mappings applicable for the physical sidelink shared channel.

Table 9.3.2-1: PSSCH modulation schemes

Physical channel	Modulation schemes
PSSCH	QPSK, 16QAM, 64QAM

9.3.3 Layer mapping

Layer mapping shall be done according to clause 5.3.2A assuming a single antenna port, $\nu=1$.

9.3.4 Transform precoding

Transform precoding shall be done according to clause 5.3.3 with M_{RB}^{PUSCH} and M_{sc}^{PUSCH} replaced by M_{RB}^{PSSCH} and M_{sc}^{PSSCH} , respectively.

9.3.5 Precoding

Precoding shall be done according to clause 5.3.3A assuming a single antenna port, $\nu=1$.

9.3.6 Mapping to physical resources

The block of complex-valued symbols $z(0), \dots, z(M_{\text{symb}}^{\text{ap}} - 1)$ shall be multiplied with the amplitude scaling factor β_{PSSCH} in order to conform to the transmit power P_{PSSCH} specified in [4], and mapped in sequence starting with $z(0)$ to physical resource blocks on antenna port p and assigned for transmission of PSSCH. The mapping to resource elements (k, l) corresponding to the physical resource blocks assigned for transmission and not used for transmission of reference signals shall be in increasing order of first the index k , then the index l , starting with the first slot in the subframe. If Transmission Format of SCI format 1 is set to 1, the resource elements in the last SC-FDMA symbol within a subframe shall not be considered in the mapping process. Otherwise, the resource elements in the last SC-FDMA symbol within a subframe shall be counted in the mapping process but not transmitted.

If sidelink frequency hopping is disabled the set of physical resource blocks to be used for transmission is given by $n_{\text{PRB}} = n'_{\text{VRB}}$ where n'_{VRB} is obtained from [4, clause 14.1.1.2.1].

If sidelink frequency hopping with type 1 hopping is enabled, the set of physical resource blocks to be used for transmission is given by [4].

If sidelink frequency hopping with predefined hopping pattern is enabled, the set of physical resource blocks to be used for transmission is given by the sidelink control information together with a predefined pattern in clause 5.3.4 with the following exceptions:

- only inter-subframe hopping shall be used
- the number of subbands $N_{\text{sb}} \in \{1, 2, 4\}$ is given by higher layers as described in [4, clause 14.1.1.2]
- the quantity $N_{\text{RB}}^{\text{HO}} \in \{0, \dots, 110\}$ is given by higher layers as described in [4, clause 14.1.1.2]
- the quantity $n_s = n_{\text{ss}}^{\text{PSSCH}}$ where $n_{\text{ss}}^{\text{PSSCH}}$ is given by clause 9.2.4
- the quantity $\text{CURRENT_TX_NB} = n_{\text{ssf}}^{\text{PSSCH}}$
- the pseudo-random sequence generator is initialized at the start of each slot fulfilling $n_{\text{ss}}^{\text{PSSCH}} = 0$ with the initialization value $c_{\text{init}} \in \{0, 1, \dots, 503, 510\}$ given by *hoppingParameter-r12* in [9]

- the quantity n_{VRB} shall be replaced by n'_{VRB} , given by [4, clause 14.1.1.2.1]
- for sidelink transmission mode 1
 - $N_{\text{RB}}^{\text{UL}} = N_{\text{RB}}^{\text{SL}}$
- for sidelink transmission mode 2
 - $N_{\text{RB}}^{\text{UL}} = M_{\text{RB}}^{\text{PSSCH,RP}}$ where $M_{\text{RB}}^{\text{PSSCH,RP}}$ is given by [4, clause 14.1.3]
 - the quantity n_{PRB} shall be replaced by n'_{PRB} , given by [4, clause 14.1.1.4]
 - the physical resource block to use for transmission $n_{\text{PRB}} = m'_{i_{\text{PRB}}}$ with m_j^{PSSCH} given by [4, clause 14.1.3]

9.4 Physical Sidelink Control Channel

9.4.1 Scrambling

The block of bits $b(0), \dots, b(M_{\text{bit}} - 1)$, where M_{bit} is the number of bits transmitted on the physical sidelink control channel in one subframe shall be scrambled according to clause 5.3.1.

The scrambling sequence generator shall be initialised with $c_{\text{init}} = 510$ at the start of every PSCCH subframe.

9.4.2 Modulation

Modulation shall be done according to clause 5.3.2. Table 9.4.2-1 specifies the modulation mappings applicable for the physical sidelink control channel.

Table 9.4.2-1: PSCCH modulation schemes

Physical channel	Modulation schemes
PSCCH	QPSK

9.4.3 Layer mapping

Layer mapping shall be done according to clause 5.3.2A assuming a single antenna port, $\nu = 1$.

9.4.4 Transform precoding

Transform precoding shall be done according to clause 5.3.3 with $M_{\text{RB}}^{\text{PUSCH}}$ and $M_{\text{sc}}^{\text{PUSCH}}$ replaced by $M_{\text{RB}}^{\text{PSCCH}}$ and $M_{\text{sc}}^{\text{PSCCH}}$, respectively.

9.4.5 Precoding

Precoding shall be done according to clause 5.3.3A assuming a single antenna port, $\nu = 1$.

9.4.6 Mapping to physical resources

The block of complex-valued symbols $z(0), \dots, z(M_{\text{ymb}}^{\text{ap}} - 1)$ shall be multiplied with the amplitude scaling factor β_{PSCCH} in order to conform to the transmit power P_{PSCCH} specified in [4], and mapped in sequence starting with $z(0)$ to physical resource blocks on antenna port p and assigned for transmission of PSCCH. The mapping to resource elements (k, l) corresponding to the physical resource blocks assigned for transmission and not used for transmission of

reference signals shall be in increasing order of first the index k , then the index l , starting with the first slot in the subframe. Resource elements in the last SC-FDMA symbol within a subframe shall be counted in the mapping process but not transmitted.

9.5 Physical Sidelink Discovery Channel

9.5.1 Scrambling

The block of bits $b(0), \dots, b(M_{\text{bit}} - 1)$, where M_{bit} is the number of bits transmitted on the physical sidelink discovery channel in one subframe shall be scrambled according to clause 5.3.1.

The scrambling sequence generator shall be initialised with $c_{\text{init}} = 510$ at the start of each PSDCH subframe.

9.5.2 Modulation

Modulation shall be done according to clause 5.3.2. Table 9.5.2-1 specifies the modulation mappings applicable for the physical sidelink discovery channel.

Table 9.5.2-1: Sidelink modulation schemes

Physical channel	Modulation schemes
PSDCH	QPSK

9.5.3 Layer mapping

Layer mapping shall be done according to clause 5.3.2A assuming a single antenna port, $\nu = 1$.

9.5.4 Transform precoding

Transform precoding shall be done according to clause 5.3.3 with $M_{\text{RB}}^{\text{PUSCH}}$ and $M_{\text{sc}}^{\text{PUSCH}}$ replaced by $M_{\text{RB}}^{\text{PSDCH}}$ and $M_{\text{sc}}^{\text{PSDCH}}$, respectively.

9.5.5 Precoding

Precoding shall be done according to clause 5.3.3A assuming a single antenna port, $\nu = 1$.

9.5.6 Mapping to physical resources

The block of complex-valued symbols $z(0), \dots, z(M_{\text{symp}}^{\text{ap}} - 1)$ shall be multiplied with the amplitude scaling factor β_{PSDCH} in order to conform to the transmit power P_{PSDCH} specified in [4], and mapped in sequence starting with $z(0)$ to physical resource blocks on antenna port p and assigned for transmission of PSDCH. The mapping to resource elements (k, l) corresponding to the physical resource blocks assigned for transmission and not used for transmission of reference signals shall be in increasing order of first the index k , then the index l , starting with the first slot in the subframe. Resource elements in the last SC-FDMA symbol within a subframe shall be counted in the mapping process but not transmitted.

The set of physical resource blocks that shall be used are given by [4, clause 14.3.1].

9.6 Physical Sidelink Broadcast Channel

9.6.1 Scrambling

The block of bits $b(0), \dots, b(M_{\text{bit}} - 1)$, where M_{bit} is the number of bits transmitted on the physical sidelink broadcast channel in one subframe, shall be scrambled according to clause 5.3.1. The scrambling sequence generator shall be initialised at the start of every PSBCH subframe with $c_{\text{init}} = N_{\text{ID}}^{\text{SL}}$.

9.6.2 Modulation

Modulation shall be done according to clause 5.3.2. Table 9.6.2-1 specifies the modulation mappings applicable for the physical sidelink broadcast channel.

Table 9.6.2-1: PSBCH modulation schemes

Physical channel	Modulation schemes
PSBCH	QPSK

9.6.3 Layer mapping

Layer mapping shall be done according to clause 5.3.2A assuming a single antenna port, $\nu=1$.

9.6.4 Transform precoding

Transform precoding shall be done according to clause 5.3.3 with $M_{\text{RB}}^{\text{PUSCH}}$ and $M_{\text{sc}}^{\text{PUSCH}}$ replaced by $M_{\text{RB}}^{\text{PSBCH}}$ and $M_{\text{sc}}^{\text{PSBCH}}$, respectively.

9.6.5 Precoding

Precoding shall be done according to clause 5.3.3A assuming a single antenna port, $\nu=1$.

9.6.6 Mapping to physical resources

The block of complex-valued symbols $z(0), \dots, z(M_{\text{symb}}^{\text{ap}} - 1)$ shall be multiplied with the amplitude scaling factor β_{PSBCH} in order to conform to the transmit power P_{PSBCH} specified in [4], and mapped in sequence starting with $z(0)$ to physical resource blocks on antenna port p . The PSBCH shall use the same set of resource blocks as the synchronization signal. The mapping to resource elements (k, l) corresponding to the physical resource blocks used for the PSBCH and not used for transmission of reference signals or synchronization signals shall be in increasing order of first the index k , then the index l , starting with the first slot in the subframe. The resource-element index k given by

$$k = k' - 36 + \frac{N_{\text{RB}}^{\text{SL}} N_{\text{sc}}^{\text{RB}}}{2}, \quad k' = 0, 1, \dots, 71$$

Resource elements in the last SC-FDMA symbol within a subframe should be counted in the mapping process but not transmitted.

9.7 Sidelink Synchronization Signals

A physical-layer sidelink synchronization identity is represented by $N_{\text{ID}}^{\text{SL}} \in \{0, 1, \dots, 335\}$, divided into two sets `id_net` and `id_oon` consisting of identities $\{0, 1, \dots, 167\}$ and $\{168, 169, \dots, 335\}$, respectively.

9.7.1 Primary sidelink synchronization signal

The primary sidelink synchronization signal is transmitted in two adjacent SC-FDMA symbols in the same subframe.

9.7.1.1 Sequence generation

Each of the two sequences $d_i(0), \dots, d_i(61), i=1,2$ used for the primary sidelink synchronization signal in the two SC-FDMA symbols is given by clause 6.11.1.1 with root index $u=26$ if $N_{\text{ID}}^{\text{SL}} \leq 167$ and $u=37$ otherwise.

9.7.1.2 Mapping to resource elements

The sequence $d_i(n)$ shall be multiplied with the amplitude scaling factor $\sqrt{72/62} \cdot \beta_{\text{PSBCH}}$ and mapped to resource elements on antenna port 1020 in the first slot in the subframe according to

$$a_{k,l} = d_i(n), \quad n = 0, \dots, 61$$

$$k = n - 31 + \frac{N_{\text{RB}}^{\text{SL}} N_{\text{sc}}^{\text{RB}}}{2}$$

$$l = \begin{cases} 1,2 & \text{normal cyclic prefix} \\ 0,1 & \text{extended cyclic prefix} \end{cases}$$

9.7.2 Secondary sidelink synchronization signal

The secondary sidelink synchronization signal is transmitted in two adjacent SC-FDMA symbols in the same subframe.

9.7.2.1 Sequence generation

Each of the two sequences $d_i(0), \dots, d_i(61), i=1,2$ used for the secondary sidelink synchronization signal is given by clause 6.11.2.1 assuming

- subframe 0 with $N_{\text{ID}}^{(1)} = N_{\text{ID}}^{\text{SL}} \bmod 168$ and $N_{\text{ID}}^{(2)} = \lfloor N_{\text{ID}}^{\text{SL}} / 168 \rfloor$ for transmission modes 1 and 2, and
- subframe 5 for transmission modes 3 and 4.

9.7.2.2 Mapping to resource elements

The sequence $d_i(n)$ shall be multiplied with the amplitude scaling factor β_{SSSS} in order to conform to the transmit power specified in clause 14.4 in 3GPP TS 36.213 [4] and mapped to resource elements on antenna port 1020 in the second slot in the subframe according to

$$a_{k,l} = d_i(n), \quad n = 0, \dots, 61$$

$$k = n - 31 + \frac{N_{\text{RB}}^{\text{SL}} N_{\text{sc}}^{\text{RB}}}{2}$$

$$l = \begin{cases} 4,5 & \text{normal cyclic prefix} \\ 3,4 & \text{extended cyclic prefix} \end{cases}$$

9.8 Demodulation reference signals

Demodulation reference signals associated with PSSCH, PSCCH, PSDCH, and PSBCH transmission shall be transmitted according to PUSCH in clause 5.5.2.1 with the following exceptions:

- The parameters in Tables 9.8-1, 9.8-2, and 9.8-3 shall be used.
- The term PUSCH shall be replaced by PSSCH, PSCCH, PSDCH or PSBCH, depending on the physical channel to which the reference signal is associated.

- Antenna ports are given by Table 9.2-1.
- The set of physical resource blocks used in the mapping process shall be identical to the corresponding PSSCH/PSCCH/PSDCH/PSBCH transmission.
- The index k in the mapping process in clause 5.5.2.1.2 corresponding to the case where higher-layer parameter $ul\text{-}DMRS\text{-}IFDMA$ is not set shall be identical to that for the corresponding PSSCH/PSCCH/PSDCH/PSBCH transmission.
 - For sidelink transmission modes 3 and 4 on the PSSCH and PSCCH, the mapping shall use $l = 2$ and $l = 5$ for the first slot in the subframe and $l = 1$ and $l = 4$ for the second slot in the subframe.
 - For sidelink transmission modes 3 and 4 on the PSBCH, the mapping shall use $l = 4$ and $l = 6$ for the first slot in the subframe and $l = 2$ for the second slot in the subframe.
- For sidelink transmission modes 1 and 2, the pseudo-random sequence generator in clause 5.5.1.3 shall be initialized at the start of each slot fulfilling $n_{ss}^{PSSCH} = 0$. For sidelink transmission modes 3 and 4 the pseudo-random sequence generator in clause 5.5.1.3 shall be initialized at the start of each slot fulfilling $n_{ss}^{PSSCH} \bmod 2 = 0$.
- For sidelink transmission modes 3 and 4 on the PSCCH, the cyclic shift $n_{cs,\lambda}$ to be applied for all DM-RS in a subframe shall be chosen according to clause 14.2.1 of [4].
- For sidelink transmission modes 1 and 2 and sidelink discovery, the quantity m in clause 5.5.2.1.1 takes the values $m = 0,1$ and for sidelink transmission modes 3 and 4, the quantity m in clause 5.5.2.1.1 takes the values $m = 0,1,2,3$ for PSSCH and $m = 0,1,2$ for PSBCH.
- For sidelink transmission modes 3 and 4, the quantity n_{ID}^X equals the decimal representation of CRC on the PSCCH transmitted in the same subframe as the PSSCH according to $n_{ID}^X = \sum_{i=0}^{L-1} p_i \cdot 2^{L-1-i}$ with p and L given by clause 5.1.1 in [3].

Table 9.8-1: Reference signal parameters for PSSCH.

Parameter in clause 5.5.2.1	PSSCH	
	Sidelink transmission modes 1 and 2	Sidelink transmission modes 3 and 4
Group hopping	enabled	enabled
	n_{ID}^{RS}	n_{ID}^{SA}
	n_s	n_{ss}^{PSSCH}
	f_{ss}	$n_{ID}^{SA} \bmod 30$
Sequence hopping	disabled	disabled
Cyclic shift	$n_{cs,\lambda}$	$\lfloor n_{ID}^{SA} / 2 \rfloor \bmod 8$
Orthogonal sequence	$\left[w^{\lambda}(\cdot) \right]$	$\left[+1 \ +1 \right]$ if $n_{ID}^{SA} \bmod 2 = 0$ $\left[+1 \ -1 \right]$ if $n_{ID}^{SA} \bmod 2 = 1$
Reference signal length	M_{sc}^{RS}	M_{sc}^{PSSCH}
Number of layers	ν	1
Number of antenna ports	P	1

Table 9.8-2: Reference signal parameters for PSCCH.

Parameter in clause 5.5.2.1	PSCCH		
	Sidelink transmission modes 1 and 2	Sidelink transmission modes 3 and 4	
Group hopping		disabled	disabled
	n_{ID}^{RS}	-	-
	n_s	-	-
	f_{ss}	0	8
Sequence hopping		disabled	disabled
Cyclic shift	$n_{cs,\lambda}$	0	{0, 3, 6, 9}
Orthogonal sequence	$[w^\lambda(\cdot)]$	[+1 +1]	[+1 +1 +1 +1]
Reference signal length	M_{sc}^{RS}	M_{sc}^{PSCCH}	M_{sc}^{PSCCH}
Number of layers	ν	1	1
Number of antenna ports	P	1	1

Table 9.8-3: Reference signal parameters for PSDCH and PSBCH.

Parameter in clause 5.5.2.1	PSDCH	PSBCH	
		Sidelink transmission modes 1 and 2	Sidelink transmission modes 3 and 4
Group hopping	disabled	disabled	disabled
	f_{ss}	0	$\lfloor N_{ID}^{SL}/16 \rfloor \bmod 30$
Sequence hopping	disabled	disabled	disabled
Cyclic shift	$n_{cs,\lambda}$	0	$\lfloor N_{ID}^{SL}/2 \rfloor \bmod 8$
(Orthogonal) sequence	$[\dots w^\lambda(m) \dots]$	[+1 +1]	$[+1 +1 +1]$ if $N_{ID}^{SL} \bmod 2 = 0$ $[+1 -1 +1]$ if $N_{ID}^{SL} \bmod 2 = 1$
Reference signal length	M_{sc}^{RS}	M_{sc}^{PSDCH}	M_{sc}^{PSBCH}
Number of layers	ν	1	1
Number of antenna ports	P	1	1

9.9 SC-FDMA baseband signal generation

The time-continuous signal $s_l^{(p)}(t)$ for antenna port p in SC-FDMA symbol l in a sidelink slot is defined by clause 5.6 with N_{RB}^{UL} replaced by N_{RB}^{SL} .

The cyclic prefix length for each sidelink channel or signal may differ from that configured for uplink transmissions.

9.10 Timing

Transmission of a sidelink radio frame number i from the UE shall start $(N_{TA,SL} + N_{TA,offset}) \cdot T_s$ seconds before the start of the corresponding timing reference frame i at the UE. The UE is not required to receive sidelink or downlink transmissions earlier than $624 T_s$ after the end of a sidelink transmission.

For PSDCH transmission and sidelink synchronization signal transmission for PSDCH:

if the UE has a serving cell fulfilling the S criterion according to [10, clause 5.2.3.2]

- the timing of reference radio frame i equals that of downlink radio frame i of the cell c as given in Clause 14.3.1 of [4] and
- $N_{TA,offset}$ is given by clause 8.1,

otherwise

- the timing of reference radio frame i is implicitly obtained from [4] and
- $N_{TA\ offset} = 0$.

For all other sidelink transmissions:

if the UE has a serving cell fulfilling the S criterion according to [10, clause 5.2.3.2]

- the timing of reference radio frame i equals that of downlink radio frame i in the cell with the same uplink carrier frequency as the sidelink and
- $N_{TA\ offset}$ is given by clause 8.1,

otherwise

- the timing of reference radio frame i is implicitly obtained from [4] and
- $N_{TA\ offset} = 0$.

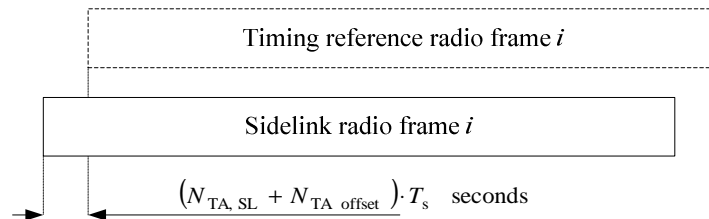

Figure 9.9-1: Sidelink timing relation.

The quantity $N_{TA,SL}$ differs between channels and signals according to

$$N_{TA,SL} = \begin{cases} N_{TA} & \text{for PSSCH in sidelink transmission mode 1} \\ 0 & \text{for all other cases} \end{cases}$$

10 Narrowband IoT

10.0 General

10.0.1 Frame structure

10.0.1.1 Frame structure type 1

Frame structure type 1 is applicable to FDD operation only.

10.0.1.2 Frame structure type 2

Frame structure type 2 is applicable to TDD operation only.

The following restrictions apply:

- Uplink-downlink configuration 0 and 6 are not supported.
- UpPTS is not used for NPUSCH or NPRACH.

- DwPTS and UpPTS in special subframe configuration 10 is not used for transmissions.
- On an NB-IoT carrier for which higher-layer parameter *operationModeInfo* indicates *inband-SamePCI* or *inband-DifferentPCI*, or higher-layer parameter *inbandCarrierInfo* is present, or on an NB-IoT carrier for *SystemInformationBlockType1-NB* for which *sib1-carrierInfo* indicates *non-anchor* and the value of the higher layer parameter *sib-GuardbandInfo* is set to *sib-GuardbandInbandSamePCI* or *sib-GuardbandInbandDiffPCI*, DwPTS in special subframe configuration 0 and 5 for normal cyclic prefix is not used for NPDCCH and NPDSCH transmission.
- Higher-layer parameter *symbolBitmap* does not apply to special subframes.

10.1 Uplink

10.1.1 Overview

10.1.1.1 Physical channels

The following narrowband physical channels are defined:

- Narrowband Physical Uplink Shared Channel, NPUSCH
- Narrowband Physical Random-Access Channel, NPRACH

10.1.1.2 Physical signals

The following uplink narrowband physical signals are defined:

- Narrowband demodulation reference signal

10.1.2 Slot structure and physical resources

10.1.2.1 Resource grid

A transmitted physical channel or signal in a slot is described by one or several resource grids of N_{sc}^{UL} subcarriers and N_{symb}^{UL} SC-FDMA symbols. The resource grid is illustrated in Figure 10.1.2.1-1. The slot number within a radio frame is denoted n_s where $n_s \in \{0,1,\dots,19\}$ for $\Delta f = 15$ kHz and $n_s \in \{0,1,\dots,4\}$ for $\Delta f = 3.75$ kHz .

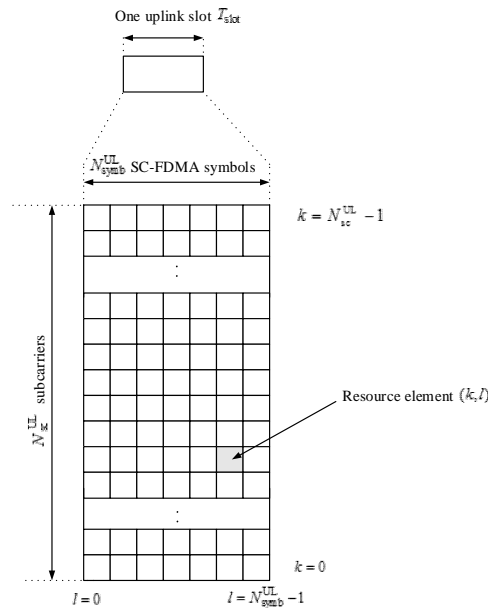

Figure 10.1.2.1-1: Uplink resource grid for NB-IoT

The uplink bandwidth in terms of subcarriers N_{sc}^{UL} , and the slot duration T_{slot} are given in Table 10.1.2.1-1.

Table 10.1.2.1-1: NB-IoT parameters.

Subcarrier spacing	N_{sc}^{UL}	T_{slot}
$\Delta f = 3.75$ kHz	48	$61440 T_s$
$\Delta f = 15$ kHz	12	$15360 T_s$

A single antenna port $p = 0$ is used for all uplink transmissions.

10.1.2.2 Resource elements

Each element in the resource grid is called a resource element and is uniquely defined by the index pair (k, l) in a slot where $k = 0, \dots, N_{sc}^{UL} - 1$ and $l = 0, \dots, N_{symb}^{UL} - 1$ are the indices in the frequency and time domains, respectively.

Resource element (k, l) corresponds to the complex value $a_{k,l}$. Quantities $a_{k,l}$ corresponding to resource elements not used for transmission of a physical channel or a physical signal in a slot shall be set to zero.

10.1.2.3 Resource unit

Resource units are used to describe the mapping of the NPUSCH to resource elements. A resource unit is defined as $N_{symb}^{UL} N_{slots}^{UL}$ SC-FDMA symbols in the time domain and N_{sc}^{RU} consecutive subcarriers in the frequency domain, where N_{sc}^{RU} and N_{symb}^{UL} are given by Tables 10.1.2.3-1 and 10.1.2.3-2 for frame structure types 1 and 2, respectively.

Table 10.1.2.3-1: Supported combinations of N_{sc}^{RU} , N_{slots}^{UL} , and N_{symb}^{UL} for frame structure type 1.

NPUSCH format	Δf	N_{sc}^{RU}	N_{slots}^{UL}	N_{symb}^{UL}
1	3.75 kHz	1	16	7
	15 kHz	1	16	
		3	8	
		6	4	
		12	2	
2	3.75 kHz	1	4	
	15 kHz	1	4	

Table 10.1.2.3-2: Supported combinations of N_{sc}^{RU} , N_{slots}^{UL} , and N_{symb}^{UL} for frame structure type 2.

NPUSCH format	Δf	Supported uplink-downlink configurations	N_{sc}^{RU}	N_{slots}^{UL}	N_{symb}^{UL}
1	3.75 kHz	1, 4	1	16	7
	15 kHz	1, 2, 3, 4, 5	1	16	
			3	8	
			6	4	
			12	2	
2	3.75 kHz	1, 4	1	4	
	15 kHz	1, 2, 3, 4, 5	1	4	

10.1.3 Narrowband physical uplink shared channel

The narrowband physical uplink shared channel supports two formats:

- NPUSCH format 1, used to carry the UL-SCH
- NPUSCH format 2, used to carry uplink control information

10.1.3.1 Scrambling

Scrambling shall be done according to clause 5.3.1. The scrambling sequence generator shall be initialised with

$c_{init} = n_{RNTI} \cdot 2^{14} + n_f \bmod 2 \cdot 2^{13} + \lfloor n_s/2 \rfloor \cdot 2^9 + N_{ID}^{Ncell}$ where n_s is the first slot of the transmission of the codeword. In case of NPUSCH repetitions, the scrambling sequence shall be reinitialised according to the above formula after every $M_{identical}^{NPUSCH}$ transmissions of the codeword with n_s and n_f set to the first slot and the frame, respectively, used for the transmission of the repetition. The quantity $M_{identical}^{NPUSCH}$ is given by clause 10.1.3.6.

10.1.3.2 Modulation

Modulation shall be done according to clause 5.3.2 resulting in a block of modulated symbols

$d^{(q)}(0), \dots, d^{(q)}(M_{symb}^{(q)} - 1)$. Table 10.1.3.2-1 specifies the modulation mappings applicable for the narrowband physical uplink shared channel.

The block of modulated symbols shall be multiplied with a code c_{SR} resulting in a block of modulation symbols

$\bar{d}^{(q)}(0), \dots, \bar{d}^{(q)}(M_{symb}^{(q)} - 1)$ according to

$$\bar{d}^{(q)}(i) = c_{SR}(i)d^{(q)}(i)$$

where

- $c_{SR}(i) = (-1)^i, i = 0, 1, \dots, 15$ in case a positive scheduling request according to [4] is to be transmitted using NPUSCH format 2
- $c_{SR}(i) = 1$ otherwise

Table 10.1.3.2-1: NPUSCH modulation schemes

NPUSCH format	N_{sc}^{RU}	Modulation scheme
1	1	BPSK, QPSK
	>1	QPSK
2	1	BPSK

10.1.3.3 Layer mapping

Layer mapping shall be done according to clause 5.3.2A with $v=1$ using $\bar{d}^{(q)}(0), \dots, \bar{d}^{(q)}(M_{\text{symb}}^{(q)} - 1)$ instead of $d^{(q)}(0), \dots, d^{(q)}(M_{\text{symb}}^{(q)} - 1)$.

10.1.3.4 Transform precoding

Transform precoding shall be done according to clause 5.3.3 with $M_{RB}^{\text{PUSCH}} = 1$ and M_{sc}^{PUSCH} replaced by M_{sc}^{NPUSCH} .

10.1.3.5 Precoding

Precoding shall be done according to clause 5.3.3A assuming a single antenna port.

10.1.3.6 Mapping to physical resources

Each NPUSCH codeword can be mapped to one or more than one resource units, N_{RU} , as given by clause 16.5.1.2 of 3GPP TS 36.213 [4], each of which shall be transmitted $M_{\text{rep}}^{\text{NPUSCH}}$ times.

The block of complex-valued symbols $z(0), \dots, z(M_{\text{symb}}^{\text{ap}} - 1)$ shall be multiplied with the amplitude scaling factor β_{NPUSCH} in order to conform to the transmit power P_{NPUSCH} specified in [4], and mapped in sequence starting with $z(0)$ to subcarriers assigned for transmission of NPUSCH. The mapping to resource elements (k, l) corresponding to the subcarriers assigned for transmission and not used for transmission of reference signals, shall be in increasing order of first the index k , then the index l , starting with the first slot in the assigned resource unit.

After mapping to N_{slots} slots, the N_{slots} slots shall be repeated $M_{\text{identical}}^{\text{NPUSCH}} - 1$ additional times, before continuing the mapping of $z(\cdot)$ to the following slot, where

$$M_{\text{identical}}^{\text{NPUSCH}} = \begin{cases} \min\left(\left\lceil M_{\text{rep}}^{\text{NPUSCH}} / 2 \right\rceil, 4\right) & N_{sc}^{RU} > 1 \\ 1 & N_{sc}^{RU} = 1 \end{cases}$$

$$N_{\text{slots}} = \begin{cases} 1 & \Delta f = 3.75 \text{ kHz} \\ 2 & \Delta f = 15 \text{ kHz} \end{cases}$$

For NPUSCH Format 1 and 2 on frame structure type 2 with $\Delta f = 3.75 \text{ kHz}$,

- the NPUSCH transmission is carried out in the first set of N_{slots} slots spanning over two contiguous uplink subframes not overlapping with any uplink subframe configured as invalid;
- for TDD configuration 1 and 4, if the starting position for the NPUSCH is indicated as the second of the two contiguous uplink subframes, the NPUSCH transmission is postponed until the start of two consecutive uplink subframes.

If a mapping to N_{slots} slots or a repetition of the mapping contains a resource element which overlaps with

- any configured NPRACH resource according to *NPRACH-ConfigSIB-NB*, or

- any configured NPRACH resource according to *nprach-ParametersList* and if the UE indicates *multiCarrier-NPRACH* as supported, or
- any configured NPRACH resource configured for Early Data Transmission and if the NPUSCH transmission is during an Early Data Transmission procedure [12, Clause 7.3b],

then,

- for $\Delta f = 3.75$ kHz the NPUSCH transmission in overlapped N_{slots} slots is postponed until the next N_{slots} slots not overlapping with any configured NPRACH resource.
- for $\Delta f = 15$ kHz the NPUSCH transmission in overlapped N_{slots} slots is postponed until the next N_{slots} slots starting with the first slot satisfying $n_s \bmod 2 = 0$ and not overlapping with any configured NPRACH resource.

NPRACH gaps as defined in section 10.1.6.1 are not part of the NPRACH resource. For frame structure type 2, the valid uplink subframes which are not used for NPRACH transmission when it is not possible to map G symbol groups back-to-back are not part of the NPRACH resource. The mapping of $z(0), \dots, z(M_{\text{symb}}^{\text{ap}} - 1)$ is then repeated until $M_{\text{rep}}^{\text{NPUSCH}} N_{\text{RU}} N_{\text{slots}}^{\text{UL}}$ slots have been transmitted. After transmissions and/or postponements due to NPRACH of $256 \cdot 30720 T_s$ time units, for frame structure type 1, a gap of $40 \cdot 30720 T_s$ time units shall be inserted where the NPUSCH transmission is postponed. The portion of a postponement due to NPRACH which coincides with a gap is counted as part of the gap.

When higher layer parameter *npusch-AllSymbols* is set to false, resource elements in SC-FDMA symbols overlapping with a symbol configured with SRS according to *srs-SubframeConfig* shall be counted in the NPUSCH mapping but not used for transmission of the NPUSCH. When higher layer parameter *npusch-AllSymbols* is set to true, all symbols are transmitted.

If *subframeBitmap* or *slotBitmap* in higher layer parameter *ul-ResourceReservationConfig* is configured, then in case of NPUSCH format 1 transmission associated with C-RNTI or SPS C-RNTI using UE-specific NPDCCH search space with the Resource reservation field in the DCI set to 1 including NPUSCH format 1 transmission without a corresponding NPDCCH, or in case of NPUSCH format 2 transmission associated with C-RNTI using UE-specific NPDCCH search space,

- In a subframe for $\Delta f = 15$ kHz or a slot for $\Delta f = 3.75$ kHz that is overlapping with any fully reserved uplink subframe as defined in clause 16.5 in [4],
 - for $\Delta f = 15$ kHz, the NPUSCH transmission is postponed until the next NB-IoT uplink subframe that is not fully reserved.
 - for $\Delta f = 3.75$ kHz, the NPUSCH transmission in the slot is postponed until the next slot spanning over two contiguous uplink subframes not overlapping with any uplink subframe that is fully reserved.
- In a subframe for $\Delta f = 15$ kHz or a slot for $\Delta f = 3.75$ kHz that is not overlapping with any fully reserved uplink subframe, any SC-FDMA symbols overlapping with reserved symbols shall be counted in the NPUSCH mapping but not used for transmission of the NPUSCH.

10.1.4 Demodulation reference signal

10.1.4.1 Reference signal sequence

10.1.4.1.1 Reference signal sequence for $N_{\text{sc}}^{\text{RU}} = 1$

The reference signal sequence $\bar{r}_u(n)$ for $N_{\text{sc}}^{\text{RU}} = 1$ is defined by

$$\bar{r}_u(n) = \frac{1}{\sqrt{2}} (1 + j) (1 - 2c(n)) w(n \bmod 16), \quad 0 \leq n < M_{\text{rep}}^{\text{NPUSCH}} N_{\text{slots}}^{\text{UL}} N_{\text{RU}}$$

where the binary sequence $c(n)$ is defined by clause 7.2 and shall be initialised with $c_{\text{init}} = 35$ at the start of the NPUSCH transmission. The quantity $w(n)$ is given by Table 10.1.4.1.1-1 where $u = N_{\text{ID}}^{\text{Ncell}} \bmod 16$ for NPUSCH format 2, and for NPUSCH format 1 if group hopping is not enabled, and by clause 10.1.4.1.3 if group hopping is enabled for NPUSCH format 1.

Table 10.1.4.1.1-1: Definition of $w(n)$

u	$w(0), \dots, w(15)$															
0	1	1	1	1	1	1	1	1	1	1	1	1	1	1	1	1
1	1	-1	1	-1	1	-1	1	-1	1	-1	1	-1	1	-1	1	-1
2	1	1	-1	-1	1	1	-1	-1	1	1	-1	-1	1	1	-1	-1
3	1	-1	-1	1	1	-1	-1	1	1	-1	-1	1	1	-1	-1	1
4	1	1	1	1	-1	-1	-1	-1	1	1	1	1	-1	-1	-1	-1
5	1	-1	1	-1	-1	1	-1	1	1	-1	1	-1	-1	1	-1	1
6	1	1	-1	-1	-1	-1	1	1	1	1	-1	-1	-1	-1	1	1
7	1	-1	-1	1	-1	1	1	-1	1	-1	-1	1	-1	1	1	-1
8	1	1	1	1	1	1	1	1	-1	-1	-1	-1	-1	-1	-1	-1
9	1	-1	1	-1	1	-1	1	-1	-1	1	-1	1	-1	1	-1	1
10	1	1	-1	-1	1	1	-1	-1	-1	-1	1	1	-1	-1	1	1
11	1	-1	-1	1	1	-1	-1	1	-1	1	1	-1	-1	1	1	-1
12	1	1	1	1	-1	-1	-1	-1	-1	-1	-1	-1	1	1	1	1
13	1	-1	1	-1	-1	1	-1	1	-1	1	-1	1	1	-1	1	-1
14	1	1	-1	-1	-1	-1	1	1	-1	-1	1	1	1	1	-1	-1
15	1	-1	-1	1	-1	1	1	-1	-1	1	1	-1	1	-1	-1	1

The reference signal sequence for NPUSCH format 1 is given by:

$$r_u(n) = \bar{r}_u(n)$$

The reference signal sequence for NPUSCH format 2 is given by

$$r_u(3n + m) = \bar{w}(m) \bar{r}_u(n), \quad m = 0, 1, 2$$

where $\bar{w}(m)$ is defined in Table 5.5.2.2.1-2 with the sequence index chosen according to $(\sum_{i=0}^7 c(8n' + i) \cdot 2^i) \bmod 3$ with $c_{\text{init}} = N_{\text{ID}}^{\text{Ncell}}$. For frame structure type 1, $n' = n_s$. For frame structure type 2, $n' = (n_s + n_f) \bmod 5$ for $\Delta f = 3.75$ kHz and $n' = (n_s + n_f) \bmod 20$ for $\Delta f = 15$ kHz.

10.1.4.1.2 Reference signal sequence for $N_{\text{sc}}^{\text{RU}} > 1$

The reference signal sequences $r_u(n)$ for $N_{\text{sc}}^{\text{RU}} > 1$ is defined by a cyclic shift α of a base sequence according to

$$r_u(n) = e^{j\alpha n} e^{j\phi(n)\pi/4}, \quad 0 \leq n < N_{\text{sc}}^{\text{RU}},$$

where $\phi(n)$ is given by Table 10.1.4.1.2-1 for $N_{\text{sc}}^{\text{RU}} = 3$, Table 10.1.4.1.2-2 for $N_{\text{sc}}^{\text{RU}} = 6$ and Table 5.5.1.2-1 for $N_{\text{sc}}^{\text{RU}} = 12$.

If group hopping is not enabled, the base sequence index u is given by higher layer parameters *threeTone-BaseSequence*, *sixTone-BaseSequence*, and *twelveTone-BaseSequence* for $N_{\text{sc}}^{\text{RU}} = 3$, $N_{\text{sc}}^{\text{RU}} = 6$, and $N_{\text{sc}}^{\text{RU}} = 12$, respectively. If not signalled by higher layers, the base sequence is given by

$$u = \begin{cases} N_{\text{ID}}^{\text{Ncell}} \bmod 12 & \text{for } N_{\text{sc}}^{\text{RU}} = 3 \\ N_{\text{ID}}^{\text{Ncell}} \bmod 14 & \text{for } N_{\text{sc}}^{\text{RU}} = 6 \\ N_{\text{ID}}^{\text{Ncell}} \bmod 30 & \text{for } N_{\text{sc}}^{\text{RU}} = 12 \end{cases}$$

If group hopping is enabled, the base sequence index u is given by clause 10.1.4.1.3.

The cyclic shift α for $N_{sc}^{RU} = 3$ and $N_{sc}^{RU} = 6$ is derived from higher layer parameters *threeTone-CyclicShift* and *sixTone-CyclicShift*, respectively, as defined in Table 10.1.4.1.2-3. For $N_{sc}^{RU} = 12$, if *npusch-CyclicShift* is configured it provides the value of n_{cs} and the cyclic shift α in a slot n_s is given as $\alpha = 2\pi n_{cs}/12$, otherwise $\alpha = 0$.

Table 10.1.4.1.2-1: Definition of $\phi(n)$ for $N_{sc}^{RU} = 3$

u	$\phi(0), \phi(1), \phi(2)$		
0	1	-3	-3
1	1	-3	-1
2	1	-3	3
3	1	-1	-1
4	1	-1	1
5	1	-1	3
6	1	1	-3
7	1	1	-1
8	1	1	3
9	1	3	-1
10	1	3	1
11	1	3	3

Table 10.1.4.1.2-2: Definition of $\phi(n)$ for $N_{sc}^{RU} = 6$

u	$\phi(0), \dots, \phi(5)$					
0	1	1	1	1	3	-3
1	1	1	3	1	-3	3
2	1	-1	-1	-1	1	-3
3	1	-1	3	-3	-1	-1
4	1	3	1	-1	-1	3
5	1	-3	-3	1	3	1
6	-1	-1	1	-3	-3	-1
7	-1	-1	-1	3	-3	-1
8	3	-1	1	-3	-3	3
9	3	-1	3	-3	-1	1
10	3	-3	3	-1	3	3
11	-3	1	3	1	-3	-1
12	-3	1	-3	3	-3	-1
13	-3	3	-3	1	1	-3

Table 10.1.4.1.2-3: Definition of α

$N_{sc}^{RU} = 3$		$N_{sc}^{RU} = 6$	
<i>threeTone-CyclicShift</i>	α	<i>sixTone-CyclicShift</i>	α
0	0	0	0
1	$2\pi/3$	1	$2\pi/6$
2	$4\pi/3$	2	$4\pi/6$
		3	$8\pi/6$

10.1.4.1.3 Group hopping

For the reference signal for NPUSCH format 1, sequence-group hopping can be enabled where the sequence-group number u in slot n_s of a radio frame n_f is defined by a group hopping pattern $f_{gh}(n')$ and a sequence-shift pattern f_{ss} according to

$$u = (f_{gh}(n') + f_{ss}) \bmod N_{seq}^{RU}$$

where the number of reference signal sequences available for each resource unit size, $N_{\text{seq}}^{\text{RU}}$ is given by Table 10.1.4.1.3-1.

Table 10.1.4.1.3-1: Definition of $N_{\text{seq}}^{\text{RU}}$

$N_{\text{sc}}^{\text{RU}}$	$N_{\text{seq}}^{\text{RU}}$
1	16
3	12
6	14
12	30

Sequence-group hopping can be enabled or disabled by means of the cell-specific parameter *groupHoppingEnabled* provided by higher layers. Sequence-group hopping for NPUSCH can be disabled for a certain UE through the higher-layer parameter *groupHoppingDisabled* despite being enabled on a cell basis unless the NPUSCH transmission corresponds to a Random Access Response Grant or a retransmission of the same transport block as part of the contention based random access procedure.

The group-hopping pattern $f_{\text{gh}}(n')$ is given by

$$f_{\text{gh}}(n') = \left(\sum_{i=0}^7 c(8n' + i) \cdot 2^i \right) \bmod N_{\text{seq}}^{\text{RU}}$$

where $n' = n_s$ for $N_{\text{sc}}^{\text{RU}} > 1$. When $N_{\text{sc}}^{\text{RU}} = 1$, for frame structure type 1, n' is the slot number n_s of the first slot of the resource unit and for frame structure type 2, n' is the frame number n_f of the first slot of the resource unit. The pseudo-random sequence $c(i)$ is defined by clause 7.2. The pseudo-random sequence generator shall be initialized with $c_{\text{init}} = \lfloor N_{\text{ID}}^{\text{Ncell}} / N_{\text{seq}}^{\text{RU}} \rfloor$ at the beginning of the resource unit for $N_{\text{sc}}^{\text{RU}} = 1$ and in every even slot for $N_{\text{sc}}^{\text{RU}} > 1$.

The sequence-shift pattern f_{ss} is given by

$$f_{\text{ss}} = \left(N_{\text{ID}}^{\text{Ncell}} + \Delta_{\text{ss}} \right) \bmod N_{\text{seq}}^{\text{RU}}$$

where $\Delta_{\text{ss}} \in \{0,1,\dots,29\}$ is given by higher-layer parameter *groupAssignmentNPUSCH*. If no value is signalled, $\Delta_{\text{ss}} = 0$.

10.1.4.2 Mapping to physical resources

The sequence $r(\cdot)$ shall be multiplied with the amplitude scaling factor β_{NPUSCH} and mapped in sequence starting with $r(0)$ to the sub-carriers.

The set of sub-carriers used in the mapping process shall be identical to the corresponding NPUSCH transmission as defined in clause 10.1.3.6.

The mapping to resource elements (k,l) shall be in increasing order of first k , then l , and finally the slot number. The values of the symbol index l in a slot are given in Table 10.1.4.2-1.

Table 10.1.4.2-1: Demodulation reference signal location for NPUSCH.

NPUSCH format	Values for l	
	$\Delta f = 3.75$ kHz	$\Delta f = 15$ kHz
1	4	3
2	0,1,2	2,3,4

If *subframeBitmap* or *slotBitmap* in higher layer parameter *ul-ResourceReservationConfig* is configured, then in case of NPUSCH format 1 transmission associated with C-RNTI or SPS C-RNTI using UE-specific NPDCCH search space and the Resource reservation field in the DCI is set to 1 including NPUSCH format 1 transmission without a corresponding

NPDCCH, or in case of NPUSCH format 2 transmission associated with C-RNTI using UE-specific NPDCCH search space,

- In a subframe for $\Delta f = 15$ kHz or a slot for $\Delta f = 3.75$ kHz that is overlapping with any fully reserved uplink subframe as defined in clause 16.5 in [4],
 - for $\Delta f = 15$ kHz, the demodulation reference signal transmission is postponed until the next NB-IoT uplink subframe that is not fully reserved.
 - for $\Delta f = 3.75$ kHz, the demodulation reference signal transmission in the slot is postponed until the next slot spanning over two contiguous uplink subframes not overlapping with any uplink subframe that is fully reserved.
- In a subframe for $\Delta f = 15$ kHz or a slot for $\Delta f = 3.75$ kHz that is not overlapping with any fully reserved uplink subframe, any demodulation reference signal transmission in SC-FDMA symbols overlapping with reserved symbols is dropped.

10.1.5 SC-FDMA baseband signal generation

For $N_{sc}^{RU} > 1$, the time-continuous signal $s_l(t)$ in SC-FDMA symbol l in a slot is defined by clause 5.6 with the quantity $N_{RB}^{UL} N_{sc}^{RB}$ replaced by N_{sc}^{UL} .

For $N_{sc}^{RU} = 1$, the time-continuous signal $s_{k,l}(t)$ for sub-carrier index k in SC-FDMA symbol l in an uplink slot is defined by

$$s_{k,l}(t) = a_{k^{(-)},l} \cdot e^{j\phi_{k,l}} \cdot e^{j2\pi(k+1/2)\Delta f(t - N_{CP,l}T_s)}$$

$$k^{(-)} = k + \lfloor N_{sc}^{UL}/2 \rfloor$$

for $0 \leq t < (N_{CP,l} + N)T_s$ where parameters for $\Delta f = 15$ kHz and $\Delta f = 3.75$ kHz are given in Table 10.1.5-1, $a_{k^{(-)},l}$ is the modulation value of symbol l , and the phase rotation $\phi_{k,l}$ is defined by

$$\phi_{k,j} = \rho(\tilde{l} \bmod 2) + \varphi_k(\tilde{l})$$

$$\rho = \begin{cases} \frac{\pi}{2} & \text{for BPSK} \\ \frac{\pi}{4} & \text{for QPSK} \end{cases}$$

$$\varphi_k(\tilde{l}) = \begin{cases} 0 & \tilde{l} = 0 \\ \varphi_k(\tilde{l} - 1) + 2\pi\Delta f(k + 1/2)(N + N_{CP,l})T_s & \tilde{l} > 0 \end{cases}$$

$$\tilde{l} = 0, 1, \dots, N_{TB} M_{rep}^{NPUSCH} N_{RU} N_{slots}^{UL} N_{symb}^{UL} - 1$$

$$l = \tilde{l} \bmod N_{symb}^{UL}$$

where N_{TB} is the number of transport blocks defined in 16.5.1 of TS 36.213 [4]. If $N_{TB} > 1$ and interleaving between codewords is applied according to clause 16.5.1 of TS 36.213 [4], then the symbol counter \tilde{l} is reset at the start of the first NPUSCH codeword transmission and incremented for each symbol during the transmission of the N_{TB} NPUSCH codewords. For other cases, the symbol counter \tilde{l} is reset to 0 at the start of each NPUSCH codeword transmission and incremented for each symbol during the transmission of the NPUSCH codeword.

Table 10.1.5-1: SC-FDMA parameters for $N_{sc}^{RU} = 1$

Parameter	$\Delta f = 3.75$ kHz	$\Delta f = 15$ kHz
N	8192	2048
Cyclic prefix length $N_{CP,l}$	256	160 for $l=0$ 144 for $l=1,2,\dots,6$
Set of values for k	-24,-23,...,23	-6,-5,...,5

The SC-FDMA symbols in a slot shall be transmitted in increasing order of l , starting with $l=0$, where SC-FDMA symbol $l>0$ starts at time $\sum_{l'=0}^{l-1} (N_{CP,l'} + N)T_s$ within the slot. For $\Delta f = 3.75$ kHz, the remaining $2304T_s$ in T_{slot} are not transmitted and used for guard period.

Only normal CP is supported for Narrowband IoT uplink in this release of the specification.

10.1.6 Narrowband physical random-access channel

10.1.6.1 Time and frequency structure

The physical layer random access preamble is based on single-subcarrier frequency-hopping symbol groups. A symbol group is illustrated in Figure 10.1.6.1-1, consisting of a cyclic prefix of length T_{CP} and a sequence of N identical symbols with total length T_{SEQ} . The total number of symbol groups in a preamble repetition unit is denoted by P . The number of time-contiguous symbol groups is given by G .

The parameter values for frame structures 1 and 2 are listed in Tables 10.1.6.1-1 and 10.1.6.1-2, respectively.

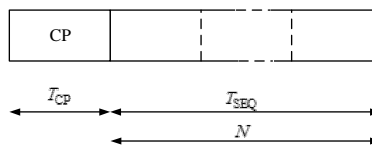
**Figure 10.1.6.1-1: Random access symbol group****Table 10.1.6.1-1: Random access preamble parameters for frame structure type 1**

Preamble format	G	P	N	T_{CP}	T_{SEQ}
0	4	4	5	$2048T_s$	$5 \cdot 8192T_s$
1	4	4	5	$8192T_s$	$5 \cdot 8192T_s$
2	6	6	3	$24576T_s$	$3 \cdot 24576T_s$

Table 10.1.6.1-2: Random access preamble parameters for frame structure type 2

Preamble format	Supported uplink-downlink configurations	G	P	N	T_{CP}	T_{SEQ}
0	1, 2, 3, 4, 5	2	4	1	$4768T_s$	$1 \cdot 8192T_s$
1	1, 4	2	4	2	$8192T_s$	$2 \cdot 8192T_s$
2	3	2	4	4	$8192T_s$	$4 \cdot 8192T_s$
0-a	1, 2, 3, 4, 5	3	6	1	$1536T_s$	$1 \cdot 8192T_s$
1-a	1, 4	3	6	2	$3072T_s$	$2 \cdot 8192T_s$

The preamble consisting of P symbol groups shall be transmitted N_{rep}^{NPRACH} times. For frame structure type 2, when an invalid uplink subframe overlaps the transmission of G symbol groups without a gap, the G symbol groups are dropped. For frame structure type 2, the transmission of G symbol groups are aligned with the subframe boundary.

The transmission of a random-access preamble, if triggered by the MAC layer, is restricted to certain time and frequency resources.

A NPRACH configuration provided by higher layers contains the following:

- NPRACH resource periodicity N_{period}^{NPRACH} (*nprach-Periodicity*),
- frequency location of the first subcarrier allocated to NPRACH $N_{sc_offset}^{NPRACH}$ (*nprach-SubcarrierOffset*),
- number of subcarriers allocated to NPRACH N_{sc}^{NPRACH} (*nprach-NumSubcarriers*),
- number of starting sub-carriers allocated to UE initiated random access $N_{sc_cont}^{NPRACH}$ (*nprach-NumCBRA-StartSubcarriers*),
- number of NPRACH repetitions per attempt N_{rep}^{NPRACH} (*numRepetitionsPerPreambleAttempt*),
- NPRACH starting time N_{start}^{NPRACH} (*nprach-StartTime*),
- Fraction for calculating starting subcarrier index for the range of NPRACH subcarriers reserved for indication of UE support for multi-tone msg3 transmission N_{MSG3}^{NPRACH} (*nprach-SubcarrierMSG3-RangeStart*).

NPRACH transmission can start only $N_{start}^{NPRACH} \cdot 30720 T_s$ time units after the start of a radio frame fulfilling $n_t \bmod (N_{period}^{NPRACH}/10) = 0$. For frame structure type 1, after transmissions of $4 \cdot 64(T_{CP} + T_{SEQ})$ time units for preamble formats 0 and 1, or $16 \cdot 6(T_{CP} + T_{SEQ})$ time units for preamble format 2, a gap of $40 \cdot 30720T_s$ time units shall be inserted.

NPRACH configurations where $N_{sc_offset}^{NPRACH} + N_{sc}^{NPRACH} > N_{sc}^{UL}$ are invalid.

The NPRACH starting subcarriers allocated to UE initiated random access are split in two sets of subcarriers, $\{0, 1, \dots, \lfloor N_{sc_cont}^{NPRACH} N_{MSG3}^{NPRACH} \rfloor - 1\}$ and $\{\lfloor N_{sc_cont}^{NPRACH} N_{MSG3}^{NPRACH} \rfloor, \dots, N_{sc_cont}^{NPRACH} - 1\}$, where the second set, if present, indicate UE support for multi-tone msg3 transmission.

The frequency location of the NPRACH transmission is constrained within $N_{sc}^{RA} = 12$ sub-carriers, and within $N_{sc}^{RA} = 36$ subcarriers when preamble format 2 as described in Table 10.1.6.1-1 is configured. Frequency hopping shall be used within the 12 subcarriers and 36 subcarriers when preamble format 2 as described in Table 10.1.6.1-1 is configured, where the frequency location of the i^{th} symbol group is given by $n_{sc}^{RA}(i) = n_{start} + \tilde{n}_{sc}^{RA}(i)$ where $n_{start} = N_{sc_offset}^{NPRACH} + \lfloor n_{init} / N_{sc}^{RA} \rfloor \cdot N_{sc}^{RA}$. The quantity $\tilde{n}_{sc}^{RA}(i)$ depends on the frame structure.

For frame structure type 1:

- if $G = 4, P = 4$ for preamble formats 0 and 1 as described in Table 10.1.6.1-1:

$$\tilde{n}_{sc}^{RA}(i) = \begin{cases} (\tilde{n}_{sc}^{RA}(0) + f(i/4)) \bmod N_{sc}^{RA} & i \bmod 4 = 0 \text{ and } i > 0 \\ \tilde{n}_{sc}^{RA}(i-1) + 1 & i \bmod 4 = 1, 3 \text{ and } \tilde{n}_{sc}^{RA}(i-1) \bmod 2 = 0 \\ \tilde{n}_{sc}^{RA}(i-1) - 1 & i \bmod 4 = 1, 3 \text{ and } \tilde{n}_{sc}^{RA}(i-1) \bmod 2 = 1 \\ \tilde{n}_{sc}^{RA}(i-1) + 6 & i \bmod 4 = 2 \text{ and } \tilde{n}_{sc}^{RA}(i-1) < 6 \\ \tilde{n}_{sc}^{RA}(i-1) - 6 & i \bmod 4 = 2 \text{ and } \tilde{n}_{sc}^{RA}(i-1) \geq 6 \end{cases}$$

$$f(t) = \left(f(t-1) + \left(\sum_{n=10t+1}^{10t+9} c(n) 2^{n-(10t+1)} \right) \bmod (N_{sc}^{RA} - 1) + 1 \right) \bmod N_{sc}^{RA}$$

$$f(-1) = 0$$

where $\tilde{n}_{sc}^{RA}(0) = n_{init} \bmod N_{sc}^{RA}$ with n_{init} being the subcarrier selected by the MAC layer from $\{0, 1, \dots, N_{sc}^{NPRACH} - 1\}$, and the pseudo random sequence $c(n)$ is given by clause 7.2. The pseudo random sequence generator shall be initialised with $c_{init} = N_{ID}^{Ncell}$.

- if $G = 6, P = 6$ for preamble format 2 as described in Table 10.1.6.1-1:

$$\tilde{n}_{sc}^{RA}(i) = \begin{cases} (\tilde{n}_{sc}^{RA}(0) + f(i/6)) \bmod N_{sc}^{RA} & i \bmod 6 = 0 \text{ and } i > 0 \\ \tilde{n}_{sc}^{RA}(i-1) + 1 & i \bmod 6 = 1, 5 \text{ and } \tilde{n}_{sc}^{RA}(i-1) \bmod 2 = 0 \\ \tilde{n}_{sc}^{RA}(i-1) - 1 & i \bmod 6 = 1, 5 \text{ and } \tilde{n}_{sc}^{RA}(i-1) \bmod 2 = 1 \\ \tilde{n}_{sc}^{RA}(i-1) + 3 & i \bmod 6 = 2, 4 \text{ and } \lfloor \tilde{n}_{sc}^{RA}(i-1)/3 \rfloor \bmod 2 = 0 \\ \tilde{n}_{sc}^{RA}(i-1) - 3 & i \bmod 6 = 2, 4 \text{ and } \lfloor \tilde{n}_{sc}^{RA}(i-1)/3 \rfloor \bmod 2 = 1 \\ \tilde{n}_{sc}^{RA}(i-1) + 18 & i \bmod 6 = 3 \text{ and } \tilde{n}_{sc}^{RA}(i-1) < 18 \\ \tilde{n}_{sc}^{RA}(i-1) - 18 & i \bmod 6 = 3 \text{ and } \tilde{n}_{sc}^{RA}(i-1) \geq 18 \end{cases}$$

$$f(t) = \left(f(t-1) + \left(\sum_{n=10t+1}^{10t+9} c(n) 2^{n-(10t+1)} \right) \bmod (N_{sc}^{RA} - 1) + 1 \right) \bmod N_{sc}^{RA}$$

$$f(-1) = 0$$

where $\tilde{n}_{sc}^{RA}(0) = n_{init} \bmod N_{sc}^{RA}$ with n_{init} being the subcarrier selected by the MAC layer from $\{0, 1, \dots, N_{sc}^{NPRACH} - 1\}$, and the pseudo random sequence $c(n)$ is given by clause 7.2. The pseudo random sequence generator shall be initialised with $c_{init} = N_{ID}^{Ncell}$.

For frame structure type 2:

- if $G = 2, P = 4$ for preamble formats 0, 1, and 2 as described in Table 10.1.6.1-2:

$$\tilde{n}_{SC}^{RA}(i) = \begin{cases} Y & i \bmod 8 = 0, 2 \text{ and } i > 0 \\ \tilde{n}_{SC}^{RA}(i-1) + 1 & i \bmod 8 = 1 \text{ and } \tilde{n}_{SC}^{RA}(i-1) = 0, 2, 4, 6, 8, 10 \\ \tilde{n}_{SC}^{RA}(i-1) - 1 & i \bmod 8 = 1 \text{ and } \tilde{n}_{SC}^{RA}(i-1) = 1, 3, 5, 7, 9, 11 \\ \tilde{n}_{SC}^{RA}(i-1) + 6 & i \bmod 8 = 3 \text{ and } \tilde{n}_{SC}^{RA}(i-1) = 0, 1, 2, 3, 4, 5 \\ \tilde{n}_{SC}^{RA}(i-1) - 6 & i \bmod 8 = 3 \text{ and } \tilde{n}_{SC}^{RA}(i-1) = 6, 7, 8, 9, 10, 11 \\ 2 \lfloor \frac{Y}{2} \rfloor + 1 & i \bmod 8 = 4 \text{ and } \tilde{n}_{SC}^{RA}(i-4) = 0, 2, 4, 6, 8, 10 \\ 2 \lfloor \frac{Y}{2} \rfloor & i \bmod 8 = 4 \text{ and } \tilde{n}_{SC}^{RA}(i-4) = 1, 3, 5, 7, 9, 11 \\ \tilde{n}_{SC}^{RA}(i-1) - 1 & i \bmod 8 = 5 \text{ and } \tilde{n}_{SC}^{RA}(i-1) = 1, 3, 5, 7, 9, 11 \\ \tilde{n}_{SC}^{RA}(i-1) + 1 & i \bmod 8 = 5 \text{ and } \tilde{n}_{SC}^{RA}(i-1) = 0, 2, 4, 6, 8, 10 \\ Y \bmod 6 + 6 & i \bmod 8 = 6 \text{ and } \tilde{n}_{SC}^{RA}(i-4) = 0, 1, 2, 3, 4, 5 \\ Y \bmod 6 & i \bmod 8 = 6 \text{ and } \tilde{n}_{SC}^{RA}(i-4) = 6, 7, 8, 9, 10, 11 \\ \tilde{n}_{SC}^{RA}(i-1) - 6 & i \bmod 8 = 7 \text{ and } \tilde{n}_{SC}^{RA}(i-1) = 6, 7, 8, 9, 10, 11 \\ \tilde{n}_{SC}^{RA}(i-1) + 6 & i \bmod 8 = 7 \text{ and } \tilde{n}_{SC}^{RA}(i-1) = 0, 1, 2, 3, 4, 5 \end{cases}$$

$$Y = (\tilde{n}_{SC}^{RA}(0) + f(i/2)) \bmod N_{SC}^{RA}$$

$$f(t) = (f(t-1) + (\sum_{n=10t+1}^{10t+9} c(n) 2^{n-(10t+1)}) \bmod (N_{SC}^{RA} - 1) + 1) \bmod N_{SC}^{RA}$$

$$f(-1) = 0$$

where $\tilde{n}_{SC}^{RA}(0) = n_{init} \bmod N_{SC}^{RA}$ with n_{init} being the subcarrier selected by the MAC layer from $\{0, 1, \dots, N_{SC}^{NPRACH} - 1\}$, and the pseudo random sequence $c(n)$ is given by clause 7.2. The pseudo random sequence generator shall be initialised with $c_{init} = N_{ID}^{Ncell}$.

- if $G = 3, P = 6$ for preamble formats 0-a, 1-a, as described in Table 10.1.6.1-2:

$$\tilde{n}_{SC}^{RA}(i) = \begin{cases} (\tilde{n}_{SC}^{RA}(0) + f(i/3)) \bmod N_{SC}^{RA} & i \bmod 6 = 0, 3 \text{ and } i > 0 \\ \tilde{n}_{SC}^{RA}(i-1) + 1 & i \bmod 6 = 1 \text{ and } \tilde{n}_{SC}^{RA}(i-1) = 0, 2, 4, 6, 8, 10 \\ \tilde{n}_{SC}^{RA}(i-1) - 1 & i \bmod 6 = 2 \text{ and } \tilde{n}_{SC}^{RA}(i-2) = 0, 2, 4, 6, 8, 10 \\ \tilde{n}_{SC}^{RA}(i-1) - 1 & i \bmod 6 = 1 \text{ and } \tilde{n}_{SC}^{RA}(i-1) = 1, 3, 5, 7, 9, 11 \\ \tilde{n}_{SC}^{RA}(i-1) + 1 & i \bmod 6 = 2 \text{ and } \tilde{n}_{SC}^{RA}(i-2) = 1, 3, 5, 7, 9, 11 \\ \tilde{n}_{SC}^{RA}(i-1) + 6 & i \bmod 6 = 4 \text{ and } \tilde{n}_{SC}^{RA}(i-1) = 0, 1, 2, 3, 4, 5 \\ \tilde{n}_{SC}^{RA}(i-1) - 6 & i \bmod 6 = 5 \text{ and } \tilde{n}_{SC}^{RA}(i-2) = 0, 1, 2, 3, 4, 5 \\ \tilde{n}_{SC}^{RA}(i-1) - 6 & i \bmod 6 = 4 \text{ and } \tilde{n}_{SC}^{RA}(i-1) = 6, 7, 8, 9, 10, 11 \\ \tilde{n}_{SC}^{RA}(i-1) + 6 & i \bmod 6 = 5 \text{ and } \tilde{n}_{SC}^{RA}(i-2) = 6, 7, 8, 9, 10, 11 \end{cases}$$

$$f(t) = (f(t-1) + (\sum_{n=10t+1}^{10t+9} c(n) 2^{n-(10t+1)}) \bmod (N_{SC}^{RA} - 1) + 1) \bmod N_{SC}^{RA}$$

$$f(-1) = 0$$

where $\tilde{n}_{SC}^{RA}(0) = n_{init} \bmod N_{SC}^{RA}$ with n_{init} being the subcarrier selected by the MAC layer from $\{0, 1, \dots, N_{SC}^{NPRACH} - 1\}$, and the pseudo random sequence $c(n)$ is given by clause 7.2. The pseudo random sequence generator shall be initialised with $c_{init} = N_{ID}^{Ncell}$.

10.1.6.2 Baseband signal generation

The time-continuous random-access signal $s_i(t)$ for symbol group i is defined by

$$s_i(t) = \beta_{NPRACH} e^{j2\pi(n_{SC}^{RA}(i) + K k_0 + 1/2)\Delta f_{RA}(t - T_{CP})}$$

where $0 \leq t \leq T_{SEQ} + T_{CP}$, β_{NPRACH} is an amplitude scaling factor in order to conform to the transmit power P_{NPRACH} specified in clause 16.3.1 in 3GPP TS 36.213 [4], $k_0 = -N_{sc}^{UL} / 2$, $K = \Delta f / \Delta f_{RA}$ accounts for the difference in

subcarrier spacing between the random access preamble and uplink data transmission, and the location in the frequency domain controlled by the parameter $n_{SC}^{RA}(i)$ is derived from clause 10.1.6.1. The variable Δf_{RA} is given by Table 10.1.6.2-1.

Table 10.1.6.2-1: Random access baseband parameters

Preamble format	Δf_{RA}	
	Frame Structure Type 1	Frame Structure Type 2
0, 1	3.75 kHz	
0-a, 1-a		3.75 kHz
2	1.25 kHz	3.75 kHz

10.1.7 Modulation and upconversion

Modulation and upconversion to the carrier frequency of the complex-valued baseband signal or the complex-valued NPRACH baseband signal is shown in Figure 5.8-1. The filtering required prior to transmission is defined by the requirements in 3GPP TS 36.101 [7].

10.2 Downlink

10.2.1 Overview

10.2.1.1 Physical channels

A downlink narrowband physical channel corresponds to a set of resource elements carrying information originating from higher layers and is the interface defined between 3GPP TS 36.212 [3] and the present document 3GPP TS 36.211.

The following downlink physical channels are defined:

- Narrowband Physical Downlink Shared Channel, NPDSCH
- Narrowband Physical Broadcast Channel, NPBCH
- Narrowband Physical Downlink Control Channel, NPDCCH

10.2.1.2 Physical signals

A downlink narrowband physical signal corresponds to a set of resource elements used by the physical layer but does not carry information originating from higher layers. The following downlink physical signals are defined:

- Narrowband reference signal, NRS
- Narrowband synchronization signal
- Narrowband positioning reference signal, NPRS
- Narrowband wake up signal, NWUS

10.2.2 Slot structure and physical resource elements

10.2.2.1 Resource grid

The transmitted signal on one antenna port in each slot is described by a resource grid of size one resource block as defined in clause 6.2.3.

Only $\Delta f = 15$ kHz is supported.

Narrowband positioning reference signals are transmitted on antenna port $p = 2006$. The channel over which a symbol on antenna port $p = 2006$ is conveyed can be inferred from the channel over which another symbol on the same antenna port is conveyed only within M consecutive subframes where

- if the higher layer parameter *nprsBitmap* is configured, M equals the length of the *nprsBitmap*;
- if the higher layer parameter *nprsBitmap* is not configured, $M = N_{\text{NPRS}}$ where N_{NPRS} is configured by higher layers.

10.2.2.2 Resource elements

Resource elements are defined according to clause 6.2.2.

10.2.2.3 Guard period for half-duplex FDD operation

Only type-B half-duplex FDD operation is supported.

10.2.2.4 Guard period for TDD operation

For frame structure type 2, if a NB-IoT UE is configured with higher layer parameter *twoHARQ-ProcessesConfig*, a guard period is created by the UE by

- not receiving the first part of the first OFDM symbol of a downlink subframe immediately following an uplink subframe from the same UE for 15-kHz subcarrier spacing on an NB-IoT carrier for which higher-layer parameter *operationModeInfo* indicates *guardband* or *standalone*, or higher-layer parameter *inbandCarrierInfo* is not present.

10.2.3 Narrowband physical downlink shared channel

10.2.3.1 Scrambling

Scrambling shall be done according to clause 6.3.1. If the NPDSCH is carrying the BCCH, the scrambling sequence generator shall be initialised with $c_{\text{init}} = n_{\text{RNTI}} \cdot 2^{15} + (N_{\text{ID}}^{\text{Ncell}} + 1)((n_f \bmod 61) + 1)$. Otherwise, the scrambling sequence generator shall be initialised with $c_{\text{init}} = n_{\text{RNTI}} \cdot 2^{14} + n_f \bmod 2 \cdot 2^{13} + \lfloor n_s / 2 \rfloor \cdot 2^9 + N_{\text{ID}}^{\text{Ncell}}$ where n_s is the first slot of the transmission of the codeword.

In case of NPDSCH repetitions and the NPDSCH carrying the BCCH, the scrambling sequence generator shall be reinitialized according to the expression above for each repetition.

In case of NPDSCH repetitions and the NPDSCH is not carrying the BCCH, the scrambling sequence generator shall be reinitialized according to the expression above after every $\min(M_{\text{rep}}^{\text{NPDSCH}}, 4)$ transmission of the codeword with n_s and n_f set to the first slot and the frame, respectively, used for the transmission of the repetition.

10.2.3.2 Modulation

Modulation shall be done according to clause 6.3.2 using one of the modulation schemes in Table 10.2.3-1

Table 10.2.3-1: Modulation schemes

Physical channel	Modulation schemes
NPDSCH	QPSK

10.2.3.3 Layer mapping and precoding

Layer mapping and precoding shall be done according to clause 6.6.3 using the same set of antenna ports as the NPBSCH.

10.2.3.4 Mapping to resource elements

Each NPDSCH codeword can be mapped to one or more than one subframes, N_{SF} , as given by clause 16.4.1.3 of 3GPP TS 36.213 [4], each of which shall be transmitted M_{rep}^{NPDSCH} times.

For each of the antenna ports used for transmission of the physical channel, the block of complex-valued symbols $y^{(p)}(0), \dots, y^{(p)}(M_{symb}^{ap} - 1)$ shall be mapped to resource elements (k, l) which meet all of the following criteria in the current subframe:

- the subframe is not used for transmission of NPBCH, NPSS, or NSSS, and
- except in a special subframe when $M_{rep}^{NPDSCH} > 1$, they are assumed by the UE not to be used for NRS, and
- they are not overlapping with resource elements used for CRS as defined in clause 6 (if any), and
- the index l in the first slot in a subframe fulfils $l \geq l_{DataStart}$ where $l_{DataStart}$ is given by clause 16.4.1.4 of 3GPP TS 36.213 [4], and
- in addition, for frame structure type 2
 - in a special subframe, if $M_{rep}^{NPDSCH} = 1$, they are in DwPTS
 - in a special subframe, if $M_{rep}^{NPDSCH} > 1$, they are not NRS locations in subframes which are not special subframes.

The mapping of $y^{(p)}(0), \dots, y^{(p)}(M_{symb}^{ap} - 1)$ in sequence starting with $y^{(p)}(0)$ to resource elements (k, l) on antenna port p meeting the criteria above shall be in increasing order of first the index k and then the index l , starting with the first slot and ending with the second slot in a subframe. For NPDSCH not carrying BCCH, after mapping to a subframe, the subframe shall be repeated for $\min(M_{rep}^{NPDSCH}, 4) - 1$ additional subframes, before continuing the mapping of $y^{(p)}(\cdot)$ to the following subframe.

The resource elements in a special subframe that are not part of DwPTS are counted but not used in the mapping if $M_{rep}^{NPDSCH} > 1$. When $l = N_{symb}^{DL} - 5, N_{symb}^{DL} - 4$, the resource elements in a special subframe assumed by the UE for NRSs are counted but not used in the mapping if $M_{rep}^{NPDSCH} > 1$.

For frame structure type 1, for NPDSCH associated with C-RNTI when *interferenceRandomisationConfig* is used according to [11], or NPDSCH associated with RA-RNTI, TC-RNTI or P-RNTI and transmitted in an NB-IoT carrier configured by *SystemInformationBlockType22-NB*, or NPDSCH associated with C-RNTI in an NB-IoT carrier configured by *SystemInformationBlockType22-NB* when *RadioResourceConfigDedicated-NB* is not configured by higher layer, or NPDSCH associated with G-RNTI or SC-RNTI, or for frame structure type 2, for NPDSCH not carrying the BCCH, define $y_{n_f, n_s}^{(p)}(0), \dots, y_{n_f, n_s}^{(p)}(S-1)$ as the block of complex-valued symbols mapped to subframe number $\lfloor n_s / 2 \rfloor$ and radio frame number n_f . Each complex-valued symbol $y_{n_f, n_s}^{(p)}(i)$ shall be multiplied with $\theta_{n_f, n_s}(i)$ before its transmission, with

$$\theta_{n_f, n_s}(i) = \begin{cases} 1, & \text{if } c_{n_f, n_s}(2i) = 0 \text{ and } c_{n_f, n_s}(2i+1) = 0 \\ -1, & \text{if } c_{n_f, n_s}(2i) = 0 \text{ and } c_{n_f, n_s}(2i+1) = 1 \\ j, & \text{if } c_{n_f, n_s}(2i) = 1 \text{ and } c_{n_f, n_s}(2i+1) = 0 \\ -j, & \text{if } c_{n_f, n_s}(2i) = 1 \text{ and } c_{n_f, n_s}(2i+1) = 1 \end{cases}$$

where the scrambling sequence $c_{n_f, n_s}(j)$, $j = 0, \dots, 2S - 1$ is given by clause 7.2 and shall be initialized at the start of each subframe with $c_{init} = (n_{RNTI} + 1)((10n_f + \lfloor n_s / 2 \rfloor) \bmod 61 + 1)2^9 + N_{ID}^{cell}$.

The mapping of $y^{(p)}(0), \dots, y^{(p)}(M_{symb}^{ap} - 1)$ is then repeated until $M_{rep}^{NPDSCH} N_{SF}$ subframes have been transmitted. For frame structure type 2, the resource elements in a special subframe that are not part of DwPTS are counted but not used

in the repetition. When $l = N_{\text{sy mb}}^{\text{DL}} - 5, N_{\text{sy mb}}^{\text{DL}} - 4$, the resource elements in a special subframe assumed by the UE for NRSs are counted but not used in the repetition.

For NPDSCH carrying BCCH, the $y^{(p)}\left((k-1)M_{\text{sy mb}}^{\text{ap}}\right), \dots, y^{(p)}\left(kM_{\text{sy mb}}^{\text{ap}} - 1\right)$ is mapped to N_{SF} subframes in sequence and then repeated until $M_{\text{rep}}^{\text{NPDSCH}} N_{\text{SF}}$ subframes have been transmitted, where

- $k = 2$ for mapping NPDSCH carrying *SystemInformationBlockType1-NB* to subframe #3 for frame structure type 1;
- $k = 1$ otherwise.

The NPDSCH transmission can be configured by higher layers with transmission gaps where the NPDSCH transmission is postponed. There are no gaps in the NPDSCH transmission if $R_{\text{max}} < N_{\text{gap, threshold}}$ where $N_{\text{gap, threshold}}$ is given by the higher layer parameter *dl-GapThreshold* and R_{max} is given by [4]. The gap starting frame and subframe is given by $(10n_f + \lfloor n_s/2 \rfloor) \bmod N_{\text{gap, period}} = 0$ where the gap periodicity, $N_{\text{gap, period}}$, is given by the higher layer parameter *dl-GapPeriodicity*. The gap duration in number of subframes is given by $N_{\text{gap, duration}} = N_{\text{gap, coeff}} N_{\text{gap, period}}$, where $N_{\text{gap, coeff}}$ is given by the higher layer parameter *dl-GapDurationCoeff*. For NPDSCH carrying the BCCH there are no gaps in the transmission.

The UE shall not expect NPDSCH in subframe i if it is not a NB-IoT downlink subframe, except for transmissions of NPDSCH carrying *SystemInformationBlockType1-NB* in

- subframes 3 and 4 for frame structure type 1; and
- subframes 0, 4, and 5 for frame structure type 2.

In case of NPDSCH transmissions, in subframes that are not NB-IoT downlink subframes, the NPDSCH transmission is postponed until the next NB-IoT downlink subframe.

If *subframeBitmap* or *slotBitmap* in higher layer parameter *dl-ResourceReservationConfig* is configured, then in case of NPDSCH transmission associated with C-RNTI using UE-specific NPDCCH search space with the Resource reservation field in the DCI set to 1,

- In a subframe that is fully reserved as defined in clause 16.4 in [4], the NPDSCH transmission is postponed until the next NB-IoT downlink subframe that is not fully reserved.
- In a subframe that is partially reserved, the reserved OFDM symbols shall be counted in the NPDSCH mapping but not used for transmission of the NPDSCH.

10.2.4 Narrowband physical broadcast channel

10.2.4.1 Scrambling

Scrambling shall be done according to clause 6.6.1 with M_{bit} denoting the number of bits to be transmitted on the NPBCH. M_{bit} equals 1600 for normal cyclic prefix. The scrambling sequence shall be initialised with $c_{\text{init}} = N_{\text{ID}}^{\text{Ncell}}$ in radio frames fulfilling $n_f \bmod 64 = 0$.

10.2.4.2 Modulation

Modulation shall be done according to clause 6.6.2 using the modulation scheme in Table 10.2.4.2-1

Table 10.2.4.2-1: Modulation schemes for NPBCH

Physical channel	Modulation schemes
NPBCH	QPSK

10.2.4.3 Layer mapping and precoding

Layer mapping and precoding shall be done according to clause 6.6.3 with $P \in \{1,2\}$. The UE shall assume antenna ports 2000 and 2001 are used for the transmission of the narrowband physical broadcast channel.

10.2.4.4 Mapping to resource elements

The block of complex-valued symbols $y^{(p)}(0), \dots, y^{(p)}(M_{\text{ymb}}-1)$ for each antenna port is transmitted in subframe 0 for frame structure type 1 or subframe 9 for frame structure type 2 during 64 consecutive radio frames starting in each radio frame fulfilling $n_f \bmod 64 = 0$. The quantity $M_{\text{ymb}} = 800$ for normal cyclic prefix. Define $y_f^{(p)}(0), \dots, y_f^{(p)}(K-1)$ as the block of complex-valued symbols to be transmitted in subframe 0 for frame structure type 1 or subframe 9 for frame structure type 2 of radio frame $f = n_f \bmod 64$, as $y_f^{(p)}(i) = \theta_f(i) y^{(p)}(K \lfloor f/8 \rfloor + i)$, $i = 0, \dots, 99$ with $K=100$ for normal cyclic prefix, and

$$\theta_f(i) = \begin{cases} 1, & \text{if } c_f(2i) = 0 \text{ and } c_f(2i+1) = 0 \\ -1, & \text{if } c_f(2i) = 0 \text{ and } c_f(2i+1) = 1 \\ j, & \text{if } c_f(2i) = 1 \text{ and } c_f(2i+1) = 0 \\ -j, & \text{if } c_f(2i) = 1 \text{ and } c_f(2i+1) = 1 \end{cases}$$

where the scrambling sequence $c_f(j)$, $j = 0, \dots, 199$ is given by clause 7.2, and shall be initialized at the start of each radio frame with $c_{\text{init}} = (N_{\text{ID}}^{\text{Ncell}} + 1)(n_f \bmod 8 + 1)^3 \cdot 2^9 + N_{\text{ID}}^{\text{Ncell}}$. The block of complex-valued symbols

$y_f^{(p)}(0), \dots, y_f^{(p)}(K-1)$ shall be mapped in sequence starting with $y_f^{(p)}(0)$ to resource elements (k, l) . The mapping to resource elements (k, l) not reserved for transmission of reference signals shall be in increasing order of first the index k , then the index l . The first three OFDM symbols in a subframe shall not be used in the mapping process.

For the purpose of the mapping, the UE shall assume cell-specific reference signals for antenna ports 0-3 and narrowband reference signals for antenna ports 2000 and 2001 being present irrespective of the actual configuration. The frequency shift of the cell-specific reference signals shall be calculated by replacing $N_{\text{ID}}^{\text{cell}}$ with $N_{\text{ID}}^{\text{Ncell}}$ in the calculation of v_{shift} in clause 6.10.1.2.

10.2.5 Narrowband physical downlink control channel

10.2.5.1 NPDCCH formats

The narrowband physical downlink control channel carries control information. A narrowband physical control channel is transmitted on an aggregation of one or two consecutive narrowband control channel elements (NCCEs), where a narrowband control channel element corresponds to 6 consecutive subcarriers in a subframe where NCCE 0 occupies subcarriers 0 through 5 and NCCE 1 occupies subcarriers 6 through 11. The NPDCCH supports multiple formats as listed in Table 10.2.5.1-1. For NPDCCH format 1, both NCCEs belong to the same subframe.

One or two NPDCCHs can be transmitted in a subframe.

Table 10.2.5.1-1: Supported NPDCCH formats

NPDCCH format	Number of NCCEs
0	1
1	2

10.2.5.2 Scrambling

Scrambling shall be done according to clause 6.8.2. The scrambling sequence shall be initialised at the start of subframe k_0 according to [4] Clause 16.6 and after every 4th NPDCCH subframe with $c_{\text{init}} = \lfloor n_s / 2 \rfloor p^9 + N_{\text{ID}}^{\text{Ncell}}$ where n_s is the first slot of the NPDCCH subframe in which scrambling is (re-)initialized.

10.2.5.3 Modulation

Modulation shall be done according to clause 6.8.3 using the modulation scheme in Table 10.2.5.3-1

Table 10.2.5.3-1: Modulation schemes

Physical channel	Modulation schemes
NPDCCH	QPSK

10.2.5.4 Layer mapping and precoding

Layer mapping and precoding shall be done according to clause 6.6.3 using the same set of antenna ports as the NPBCH.

10.2.5.5 Mapping to resource elements

The block of complex-valued symbols $y(0), \dots, y(M_{\text{symb}} - 1)$ shall be mapped in sequence starting with $y(0)$ to resource elements (k, l) on the associated antenna port which meet all of the following criteria:

- they are part of the NCCE(s) assigned for the NPDCCH transmission, and
- they are not used for transmission of NPBCH, NPSS, or NSSS, and
- except in a special subframe when NPDCCH is transmitted in more than one subframe, they are assumed by the UE not to be used for NRS, and
- they are not overlapping with resource elements used for CRS as defined in clause 6 (if any), and
- the index l in the first slot in a subframe fulfils $l \geq l_{\text{NPDCCHStar } t}$ where $l_{\text{NPDCCHStar } t}$ is given by clause 16.6.1 of 3GPP TS 36.213 [4],
- in addition, for frame structure Type 2,
 - in a special subframe where the NPDCCH is transmitted in one subframe, they are in DwPTS
 - in a special subframe where the NPDCCH is transmitted in more than one subframe, they are not NRS locations when the subframe is not a special subframe.

The mapping to resource elements (k, l) on antenna port p meeting the criteria above shall be in increasing order of first the index k and then the index l , starting with the first slot and ending with the second slot in a subframe. Denote $y_{n_s, n_s}(0), \dots, y_{n_s, n_s}(T - 1)$ as the complex-valued symbols that are mapped to resource elements meeting the criteria above in subframe $\lfloor n_s / 2 \rfloor$, with the insertion of <NIL> elements in the locations of resource elements which are not part of the NCCE(s) assigned for the NPDCCH transmission.

If the NPDCCH is transmitted in more than one subframe, the resource elements in a special subframe that are not part of DwPTS are counted but not used in the mapping. When $l = N_{\text{symb}}^{\text{DL}} - 5, N_{\text{symb}}^{\text{DL}} - 4$, the resource elements in a special subframe assumed by the UE for NRSs are counted but not used in the mapping if the NPDCCH is transmitted in more than one subframe.

For frame structure type 1, for NPDCCH associated with RA-RNTI, TC-RNTI or P-RNTI and transmitted in an NB-IoT carrier configured by *SystemInformationBlockType22-NB*, or NPDCCH associated with C-RNTI in an NB-IoT carrier configured by *SystemInformationBlockType22-NB* when *RadioResourceConfigDedicted-NB* is not configured by higher layer, or NPDCCH associated with G-RNTI or SC-RNTI, or for NPDCCH associated with C-RNTI when

interferenceRandomisationConfig is used according to [11], or for frame structure type 2, each complex-valued symbol $y_{n_f, n_s}(i)$, $i = 0, \dots, T - 1$ shall be multiplied with $\theta_{n_f, n_s}(i)$, $i = 0, \dots, T - 1$ where

$$\theta_{n_f, n_s}(i) = \begin{cases} 1, & \text{if } c_{n_f, n_s}(2i) = 0 \text{ and } c_{n_f, n_s}(2i+1) = 0 \\ -1, & \text{if } c_{n_f, n_s}(2i) = 0 \text{ and } c_{n_f, n_s}(2i+1) = 1 \\ j, & \text{if } c_{n_f, n_s}(2i) = 1 \text{ and } c_{n_f, n_s}(2i+1) = 0 \\ -j, & \text{if } c_{n_f, n_s}(2i) = 1 \text{ and } c_{n_f, n_s}(2i+1) = 1 \end{cases}$$

where the scrambling sequence $c_{n_f, n_s}(j)$, $j = 0, \dots, 2T - 1$ is given by clause 7.2 and shall be initialized at the start of each subframe with $c_{init} = (N_{ID}^{cell} + 1)((10n_f + \lfloor n_s / 2 \rfloor) \bmod 8192 + 1)2^9 + N_{ID}^{cell}$.

The NPDCCH transmission can be configured by higher layers with transmissions gaps where the NPDCCH transmission is postponed. The configuration is the same as described for NPDSCH in clause 10.2.3.4.

The UE shall not expect NPDCCH in subframe i if it is not a NB-IoT downlink subframe. In case of NPDCCH transmissions, in subframes that are not NB-IoT downlink subframes, the NPDCCH transmission is postponed until the next NB-IoT downlink subframe.

If *subframeBitmap* or *slotBitmap* in higher layer parameter *dl-ResourceReservationConfig* is configured, then in case of NPDCCH transmission associated with C-RNTI or SPS C-RNTI using UE-specific NPDCCH search space,

- In a subframe that is fully reserved as defined in clause 16.4 in [4], the NPDCCH transmission is postponed until the next NB-IoT downlink subframe that is not fully reserved.
- In a subframe that is partially reserved, the reserved OFDM symbols shall be counted in the NPDCCH mapping but not used for transmission of the NPDCCH.

10.2.6 Narrowband reference signal (NRS)

Before a UE obtains *operationModeInfo*:

- If frame structure type 1 is used, the UE may assume narrowband reference signals (NRSs) are transmitted in subframes #0 and #4 and in subframes #9 not containing NSSS.
- If frame structure type 2 is used, the UE may assume narrowband reference signals (NRSs) are transmitted in subframes #9 and in subframes #0 not containing NSSS.

On an NB-IoT carrier for which a UE receives higher-layer parameter *operationModeInfo* indicating *guardband* or *standalone*.

- If frame structure type 1 is used, before the UE obtains *SystemInformationBlockType1-NB*, the UE may assume narrowband reference signals are transmitted in subframes #0, #1, #3, #4 and in subframes #9 not containing NSSS.
- If frame structure type 2 is used, before the UE obtains *SystemInformationBlockType1-NB*, the UE may assume narrowband reference signals are transmitted in subframes #9, and in subframes #0 not containing NSSS, and in subframes #4 if subframes #4 is configured for *SystemInformationBlockType1-NB* transmissions.
- If frame structure type 1 is used, after the UE obtains *SystemInformationBlockType1-NB*, the UE may assume narrowband reference signals are transmitted in subframes #0, #1, #3, #4, subframes #9 not containing NSSS, and in NB-IoT downlink subframes.
- If frame structure type 2 is used, after the UE obtains *SystemInformationBlockType1-NB*, the UE may assume narrowband reference signals are transmitted in subframes #9, subframes #0 not containing NSSS, in subframes #4 if subframes #4 is configured for *SystemInformationBlockType1-NB* transmissions, and in NB-IoT downlink subframes.

On an NB-IoT carrier for *SystemInformationBlockType1-NB* for which *sib1-carrierInfo-NB* indicates *non-anchor* for frame structure type 2, before the UE obtains *SystemInformationBlockType1-NB*, the UE may assume narrowband reference signals are transmitted in subframes #0 and #5. After the UE obtains *SystemInformationBlockType1-NB*, the

UE may assume narrowband reference signals are transmitted in subframes #0, #5, and in NB-IoT downlink subframes indicated by *tdd-SI-SubframesBitmap*.

On an NB-IoT carrier for which *DL-CarrierConfigCommon-NB* is present and no *inbandCarrierInfo* is present.

- If frame structure type 1 is used and when an NB-IoT UE is configured by higher layers to decode NPDCCH with CRC scrambled by the P-RNTI and higher-layer indicates *nrs-NonAnchorConfig* is enabled, the UE first determines the starting subframe of NPDCCH search space associated with NRS transmission according to [10].
- If higher-layer *nB* is configured as *fourT*, the UE may assume NRSs are transmitted in the 10th NB-IoT DL subframe before the determined starting subframe of NPDCCH search space.
- If higher-layer *nB* is configured as *twoT*, the UE may assume NRSs are transmitted in the 9th and 10th NB-IoT DL subframes before the determined starting subframe of NPDCCH search space.
- If higher-layer *nB* is configured as *oneT*, the UE may assume NRSs are transmitted in the 6th, 7th, 8th, 9th and 10th NB-IoT DL subframes before the determined starting subframe of NPDCCH search space.
- For other *nB* values, the UE may assume NRSs are transmitted in 10 NB-IoT DL subframes before the determined starting subframe of NPDCCH search space.
- When an NB-IoT UE is configured by higher layers to decode NPDCCH with CRC scrambled by the P-RNTI, the UE may assume NRSs are transmitted in the NPDCCH candidate where the UE finds a DCI with CRC scrambled by the P-RNTI. The UE may also assume NRSs are transmitted in 10 NB-IoT DL subframes before and in 4 NB-IoT DL subframes after the NPDCCH candidate where the UE finds a DCI with CRC scrambled by the P-RNTI, where NB-IoT DL subframes without NRS are not counted. If the DCI with CRC scrambled by the P-RNTI schedules a NPDSCH, the UE may assume NRSs are transmitted in the NB-IoT DL subframes carrying the NPDSCH as well as in 4 NB-IoT DL subframes before and after the scheduled NPDSCH, where NB-IoT DL subframes without NRS are not counted.
- During the window controlled by higher layers where the UE shall attempt to decode the NPDCCH with DCI scrambled by RA-RNTI (see [8], clause 5.1.4), the UE may assume NRSs are transmitted in the Type-2 CSS configured by higher layers, as well as in 10 NB-IoT DL subframes before and in 4 NB-IoT DL subframes after each Type-2 CSS, where NB-IoT DL subframes without NRS are not counted. If a DCI scrambled by the RA-RNTI is detected, the UE may assume NRSs are transmitted in the NPDSCH scheduled by the DCI scrambled by the RA-RNTI, as well as in 4 NB-IoT DL subframes before and after the scheduled NPDSCH, where NB-IoT DL subframes without NRS are not counted. In addition, when the UE attempts to decode a DCI with CRC scrambled by the RA-RNTI as well as receiving the NPDSCH scheduled by the DCI scrambled by the RA-RNTI, the UE may assume NRSs are transmitted in subframes #0, #1, #3, #4 and #9.
- During random access procedure, when an NB-IoT UE is configured by higher layers to decode NPDCCH with CRC scrambled by the temporary C-RNTI and/or the C-RNTI, before the DCI scrambled by temporary C-RNTI and/or C-RNTI is detected, the UE may assume NRSs are transmitted in the Type-2 CSS configured by higher layers, as well as in 10 NB-IoT DL subframes before the start of each Type-2 CSS and in 4 NB-IoT DL subframes after the end of each Type-2 CSS until the *mac-ContentionResolutionTimer* expires, where NB-IoT DL subframes without NRS are not counted. If a DCI scrambled by the temporary C-RNTI or C-RNTI is detected, the UE may assume NRSs are transmitted in the NPDSCH scheduled by the DCI scrambled by the temporary C-RNTI or C-RNTI as well as in 4 NB-IoT DL subframes before and after the scheduled NPDSCH, where NB-IoT DL subframes without NRS are not counted.
- An NB-IoT UE may assume NRSs are transmitted in NB-IoT DL subframes that are used for Type1A-NPDCCH common search space, and Type2A-NPDCCH common search space, as well as in 10 NB-IoT DL subframes prior and in 4 NB-IoT DL subframes after each Type1A-NPDCCH common search space and Type2A-NPDCCH common search space. A UE may assume NRSs are transmitted in NB-IoT DL subframes carrying NPDSCH scheduled by DCI CRC scrambled by G-RNTI or SC-RNTI as well as 4 NB-IoT DL subframes prior and after the scheduled NPDSCH, where NB-IoT DL subframes without NRS are not counted.
- In other cases, if frame structure *typ1* is used, the UE may assume NRSs are transmitted in subframes #0, #1, #3, #4, #9, and in NB-IoT downlink subframes and shall not expect NRSs in other downlink subframes.

On an NB-IoT carrier for which a UE receives higher-layer parameter *operationModeInfo* indicating *inband-SamePCI* or *inband-DifferentPCI*.

- If frame structure type 1 is used, before the UE obtains *SystemInformationBlockType1-NB*, the UE may assume narrowband reference signals are transmitted in subframes #0, #4 and in subframes #9 not containing NSSS, and in subframes #3 which contain *SystemInformationBlockType1-NB* when *additionalTransmissionSIB1* is configured as TRUE.
- If frame structure type 2 is used, before the UE obtains *SystemInformationBlockType1-NB*, the UE may assume narrowband reference signals are transmitted in subframes #9, and in subframes #0 not containing NSSS, and in subframes #4 if subframes #4 is configured for *SystemInformationBlockType1-NB* transmissions.
- If frame structure type 1 is used, after the UE obtains *SystemInformationBlockType1-NB*, the UE may assume narrowband reference signals are transmitted in subframes #0, #4, subframes #9 not containing NSSS, subframes #3 which contain *SystemInformationBlockType1-NB* when *additionalTransmissionSIB1* is configured as TRUE, and in NB-IoT downlink subframes.
- If frame structure type 2 is used, after the UE obtains *SystemInformationBlockType1-NB*, the UE may assume narrowband reference signals are transmitted in subframes #9, subframes #0 not containing NSSS, in subframes #4 if subframes #4 is configured for *SystemInformationBlockType1-NB* transmissions, and in NB-IoT downlink subframes

On an NB-IoT carrier for which *DL-CarrierConfigCommon-NB* is present and *inbandCarrierInfo* is present:

- If frame structure type 1 is used, when an NB-IoT UE is configured by higher layers to decode NPDCCH with CRC scrambled by the P-RNTI and higher-layer indicates *nrs-NonAnchorConfig* is enabled, the UE first determines the starting subframe of NPDCCH search space associated with NRS transmission according to [10].
 - If higher-layer *nB* is configured as *fourT*, the UE may assume NRSs are transmitted in the 10th NB-IoT DL subframe before the determined starting subframe of NPDCCH search space.
 - If higher-layer *nB* is configured as *twoT*, the UE may assume NRSs are transmitted in 9th and 10th NB-IoT DL subframes before the determined starting subframe of NPDCCH search space.
 - If higher-layer *nB* is configured as *oneT*, the UE may assume NRSs are transmitted in 6th, 7th, 8th, 9th and 10th NB-IoT DL subframes before the determined starting subframe of NPDCCH search space.
 - For other *nB* values, the UE may assume NRSs are transmitted in 10 NB-IoT DL subframes before the determined starting subframe of NPDCCH search space.
- When an NB-IoT UE is configured by higher layers to decode NPDCCH with CRC scrambled by the P-RNTI, the UE may assume NRSs are transmitted in the NPDCCH candidate where the UE finds a DCI with CRC scrambled by the P-RNTI. The UE may also assume NRSs are transmitted in 10 NB-IoT DL subframes before and in 4 NB-IoT DL subframes after the NPDCCH candidate, where NB-IoT DL subframes without NRS are not counted. If the DCI with CRC scrambled by the P-RNTI schedules a NPDSCH, the UE may assume NRSs are transmitted in the NB-IoT DL subframes carrying the NPDSCH as well as 4 NB-IoT DL subframes before and after the scheduled NPDSCH, where NB-IoT DL subframes without NRS are not counted.
- During the window controlled by higher layers where the UE shall attempt to decode the NPDCCH with DCI scrambled by RA-RNTI (see [8], clause 5.1.4), the UE may assume NRSs are transmitted in the Type-2 CSS configured by higher layers, as well as in 10 NB-IoT DL subframes before and in 4 NB-IoT DL subframes after each Type-2 CSS, where NB-IoT DL subframes without NRS are not counted. If a DCI scrambled by the RA-RNTI is detected, the UE may assume NRSs are transmitted in the NPDSCH scheduled by the DCI scrambled by the RA-RNTI, as well as in 4 NB-IoT DL subframes before and after the scheduled NPDSCH, where NB-IoT DL subframes without NRS are not counted. In addition, when the UE attempts to decode a DCI with CRC scrambled by the RA-RNTI as well as receiving the NPDSCH scheduled by the DCI scrambled by the RA-RNTI, the UE may assume NRSs are transmitted in subframes #0, #4 and #9.
- During random access procedure, when an NB-IoT UE is configured by higher layers to decode NPDCCH with CRC scrambled by the temporary C-RNTI and/or the C-RNTI, before the DCI scrambled by temporary C-RNTI and/or C-RNTI, is detected, the UE may assume NRSs are transmitted in the Type-2 CSS configured by higher layers, as well as in 10 NB-IoT DL subframes before the start of each Type-2 CSS and in 4 NB-IoT DL subframes after the end of each Type-2 CSS until the *mac-ContentionResolutionTimer* expires, where NB-IoT DL subframes without NRS are not counted. If a DCI scrambled by the temporary C-RNTI or C-RNTI is detected, the UE may assume NRSs are transmitted in the NPDSCH scheduled by the DCI scrambled by the temporary C-RNTI or C-RNTI as well as in 4 NB-IoT DL subframes before and after the scheduled NPDSCH, where NB-IoT DL subframes without NRS are not counted.

- An NB-IoT UE may assume NRSs are transmitted in NB-IoT DL subframes that are used for Type1A-NPDCCH common search space, and Type2A-NPDCCH common search space, as well as in 10 NB-IoT DL subframes prior and in 4 NB-IoT DL subframes after each Type1A-NPDCCH common search space and Type2A-NPDCCH common search space, where NB-IoT DL subframes without NRS are not counted. A UE may assume NRSs are transmitted in NB-IoT DL subframes carrying NPDSCH scheduled by DCI CRC scrambled by G-RNTI or SC-RNTI as well as in 4 NB-IoT DL subframes prior and after the scheduled NPDSCH, where NB-IoT DL subframes without NRS are not counted.
- In other cases, if frame structure type 1 is used, the UE may assume NRSs are transmitted in subframes #0, #4, #9, and in NB-IoT downlink subframes and shall not expect NRSs in other downlink subframes.

On an NB-IoT carrier for which *DL-CarrierConfigDedicated-NB* is present and no *inbandCarrierInfo* is present:

- If frame structure type 1 is used, the UE may assume NRSs are transmitted in subframes #0, #1, #3, #4, #9, and in NB-IoT downlink subframes and shall not expect NRSs in other downlink subframes.

On an NB-IoT carrier for which *DL-CarrierConfigDedicated-NB* is present and *inbandCarrierInfo* is present:

- If frame structure type 1 is used, the UE may assume NRSs are transmitted in subframes #0, #4, #9, and in NB-IoT downlink subframes and shall not expect NRSs in other downlink subframes.

An NB-IoT UE may assume NRSs are not transmitted in subframes that are configured by higher layer parameter *nprsBitmap* for narrowband positioning reference signal transmission.

10.2.6.1 Sequence generation

The narrowband reference sequence shall be initialised according to clause 6.10.1.1 where N_{ID}^{cell} is replaced with N_{ID}^{Ncell} .

10.2.6.2 Mapping to resource elements

Narrowband reference signals are transmitted on one or two antenna ports $p \in \{2000, 2001\}$.

If the higher layer indicates UE may assume that N_{ID}^{cell} is equal to N_{ID}^{Ncell} , UE may assume

- the number of antenna ports for the cell-specific reference signals as defined in clause 6.10.1 is the same as for the narrowband reference signals,
- the antenna ports for cell-specific reference signals $\{0, 1\}$ are equivalent to antenna ports for narrowband reference signals $\{2000, 2001\}$, respectively, and
- the cell-specific reference signals are available in all subframes where the narrowband reference signals are available.

If the higher layer does not indicate UE may assume that N_{ID}^{cell} is equal to N_{ID}^{Ncell} , UE may assume

- the number of antenna port for the cell-specific reference signals as defined in clause 6.10.1 is obtained from the higher layer parameter *etra-NumCRS-Ports*,
- the cell-specific reference signals are available in all subframes where the narrowband reference signals are available, and

the cell-specific frequency shift for cell-specific reference signals as defined in clause 6.10.1.2 is given by

$$v_{\text{shift}} = N_{ID}^{Ncell} \bmod 6.$$

The reference signal sequence $r_{l,n_s}(m)$ shall be mapped to complex-valued modulation symbols $a_{k,l}^{(p)}$ used as reference symbols for antenna port p in slot n_s according to

$$a_{k,l}^{(p)} = r_{l,n_s}(m')$$

where

$$\begin{aligned}
 k &= 6m + (v + v_{\text{shift}}) \bmod 6 \\
 l &= N_{\text{syml}}^{\text{DL}} - 2, N_{\text{syml}}^{\text{DL}} - 1 \\
 m &= 0, 1 \\
 m' &= m + N_{\text{RB}}^{\text{max,DL}} - 1
 \end{aligned}$$

When frame structure type 2 is used, the following values of l apply for the generation of NRSs in special subframes

- $l = N_{\text{syml}}^{\text{DL}} - 5, N_{\text{syml}}^{\text{DL}} - 4$ in each slot for special subframe configurations {3, 4, 8}
- $l = N_{\text{syml}}^{\text{DL}} - 5, N_{\text{syml}}^{\text{DL}} - 4$ in the first slot for special subframe configurations {9, 10}
- $l = N_{\text{syml}}^{\text{DL}} - 2, N_{\text{syml}}^{\text{DL}} - 1$ in the first slot for special subframe configurations {1, 2, 6, 7}.

The variables v and v_{shift} define the position in the frequency domain for the different reference signals where v is given by

$$v = \begin{cases} 0 & \text{if } p = 2000 \text{ and } l \in \{N_{\text{syml}}^{\text{DL}} - 2, N_{\text{syml}}^{\text{DL}} - 5\} \\ 3 & \text{if } p = 2000 \text{ and } l \in \{N_{\text{syml}}^{\text{DL}} - 1, N_{\text{syml}}^{\text{DL}} - 4\} \\ 3 & \text{if } p = 2001 \text{ and } l \in \{N_{\text{syml}}^{\text{DL}} - 2, N_{\text{syml}}^{\text{DL}} - 5\} \\ 0 & \text{if } p = 2001 \text{ and } l \in \{N_{\text{syml}}^{\text{DL}} - 1, N_{\text{syml}}^{\text{DL}} - 4\} \end{cases}$$

The cell-specific frequency shift is given by $v_{\text{shift}} = N_{\text{ID}}^{\text{Ncell}} \bmod 6$.

Resource elements (k, l) used for transmission of narrowband reference signals on any of the antenna ports in a slot shall not be used for any transmission on any other antenna port in the same slot and set to zero.

Narrowband reference signals shall not be transmitted in subframes containing NPSS or NSSS.

For frame structure type 2, narrowband reference signals shall not be transmitted in special subframe for configurations 0 and 5.

Figure 10.2.6.2-1 illustrates the resource elements used for reference signal transmission according to the above definition. The notation R_p is used to denote a resource element used for reference signal transmission on antenna port p .

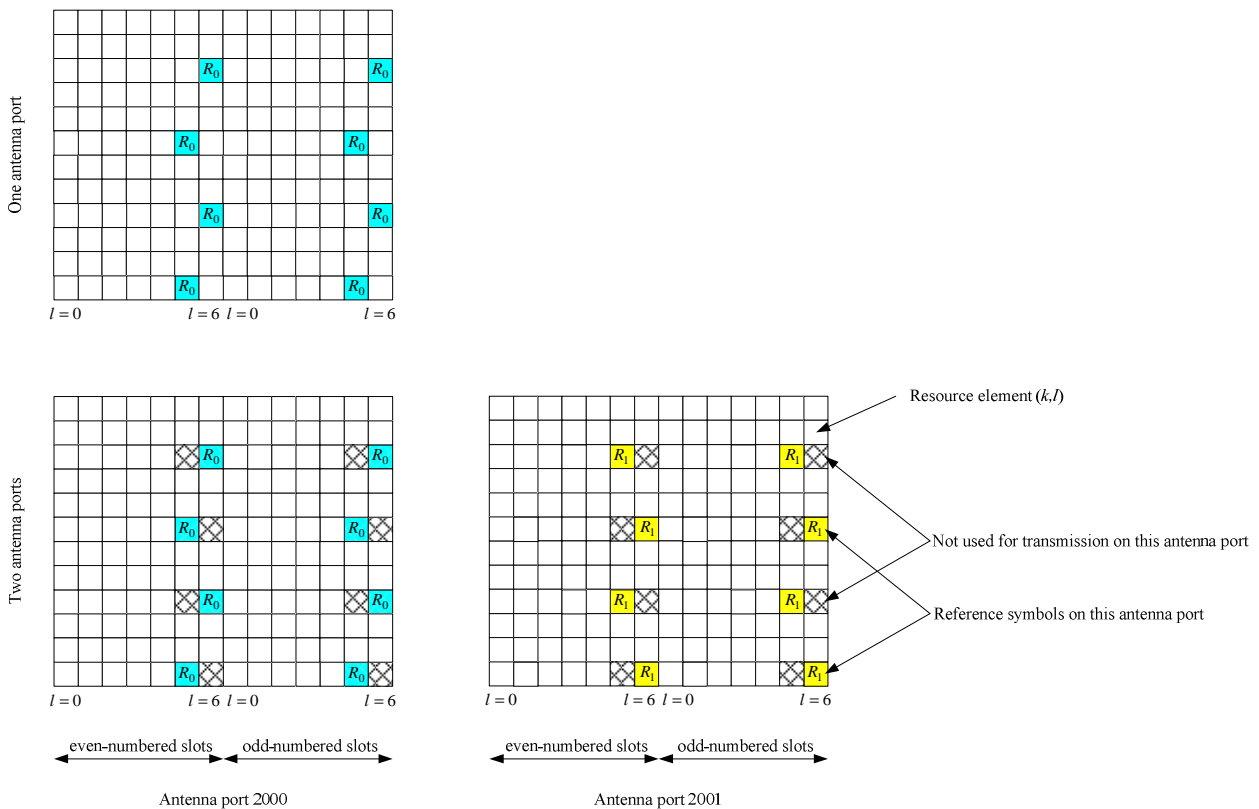

Figure 10.2.6.2-1. Mapping of downlink narrowband reference signals (normal cyclic prefix)

10.2.6A Narrowband positioning reference signal (NPRS)

Narrowband positioning reference signals (NPRSs) shall only be transmitted in resource blocks in NB-IoT carriers configured for NPRS transmission. In a subframe configured for NPRS transmission, the starting positions of the OFDM symbols configured for NPRS transmission shall be identical to those in a subframe in which all OFDM symbols have the same cyclic prefix length as the OFDM symbols configured for NPRS transmission. NPRS are defined for $\Delta f = 15$ kHz and normal CP only.

NPRSs are transmitted on antenna port 2006.

10.2.6A.1 Sequence generation

The NPRS sequence $r_{l,n_s}(m)$ is defined by

$$r_{l,n_s}(m) = \frac{1}{\sqrt{2}}(1 - 2 \cdot c(2m)) + j \frac{1}{\sqrt{2}}(1 - 2 \cdot c(2m + 1)), \quad m = 0, 1, \dots, 2N_{RB}^{\max, DL} - 1$$

where n_s is the slot number within a radio frame, l is the OFDM symbol number within the slot. The pseudo-random sequence $c(i)$ is defined in clause 7.2. The pseudo-random sequence generator shall be initialised with

$$c_{init} = 2^{28} \cdot \lfloor N_{ID}^{NPRS} / 512 \rfloor + 2^{10} \cdot (7 \cdot (n_s + 1) + l + 1) \cdot (2 \cdot (N_{ID}^{NPRS} \bmod 512) + 1) + 2 \cdot (N_{ID}^{NPRS} \bmod 512) + N_{CP}$$

at the start of each OFDM symbol where $N_{ID}^{NPRS} \in \{0, 1, \dots, 4095\}$ equals N_{ID}^{cell} unless configured by higher layers and where $N_{CP} = 1$.

10.2.6A.2 Mapping to resource elements

For an NB-IoT carrier which is configured for NPRS transmission, the reference signal sequence $r_{l,n_s}(m)$ shall be mapped to complex-valued modulation symbols $a_{k,l}^{(p)}$ used as reference signal for antenna port p in slot n_s according to, for Type 1 NPRS:

$$a_{k,l}^{(p)} = r_{l,n_s}(m')$$

or for Type 2 NPRS:

$$a_{k,l}^{(p)} = r_{l,n_s} \left((m' + 2(n_f \bmod 64)) \bmod 220 \right)$$

according to higher layer configuration, where

- when the higher layer parameter *operationModeInfoNPRS* for the configured NB-IoT carrier is set to in-band

$$k = 6m + (6 - l + v_{\text{shift}}) \bmod 6$$

$$l = \begin{cases} 3,5,6 & \text{if } n_s \bmod 2 = 0 \\ 1,2,3,5,6 & \text{if } n_s \bmod 2 = 1 \text{ and (1 or 2 PBCH antenna ports)} \\ 2,3,5,6 & \text{if } n_s \bmod 2 = 1 \text{ and (4 PBCH antenna ports)} \end{cases}$$

$$m = 0,1$$

$$m' = m + 2 n_{\text{PRB}}' + N_{\text{RB}}^{\text{max,DL}} - \tilde{n}$$

where n_{PRB}' is signalled by higher layers *nprs-SequenceInfo*, and $\tilde{n} = 1$ if the higher layer parameter *nprs-SequenceInfo* indicates $N_{\text{RB}}^{\text{DL}}$ is odd, and $\tilde{n} = 0$ if the higher layer parameter *nprs-SequenceInfo* indicates $N_{\text{RB}}^{\text{DL}}$ is even.

- when the higher layer parameter *operationModeInfoNPRS* for the configured NB-IoT carrier is set to standalone or guard-band

$$k = 6m + (6 - l + v_{\text{shift}}) \bmod 6$$

$$l = 0, 1, 2, 3, 4, 5, 6$$

$$m = 0,1$$

$$m' = m + N_{\text{RB}}^{\text{max,DL}} - 1$$

and where $v_{\text{shift}} = N_{\text{ID}}^{\text{NPRS}} \bmod 6$. If $N_{\text{ID}}^{\text{NPRS}}$ is not configured by higher layers, $N_{\text{ID}}^{\text{NPRS}} = N_{\text{ID}}^{\text{Ncell}}$. The number of PBCH antenna ports is signalled by higher layers.

If higher layer parameter *nprsBitmap* is not configured, resource elements in OFDM symbols 5 and 6 in each slot shall not be used for transmission of NPRS. If the configured periodicity of Type 1 NPRS is equal to that of Type 2 NPRS, the UE is not expected to be configured with overlapped resource elements between Type 1 NPRS and Type 2 NPRS. Otherwise, a resource element configured for Type 1 NPRS shall not be used for Type 2 NPRS.

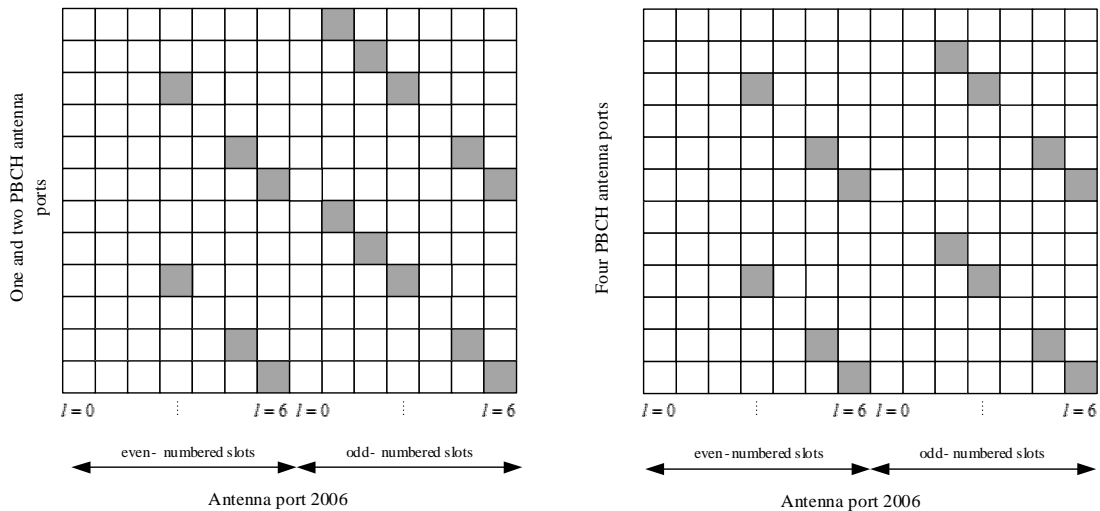

Figure 10.2.6A.2-1: Mapping of NPRS (*operationModeInfoNPRS* is set to in-band, *nprsBitmap* configured)

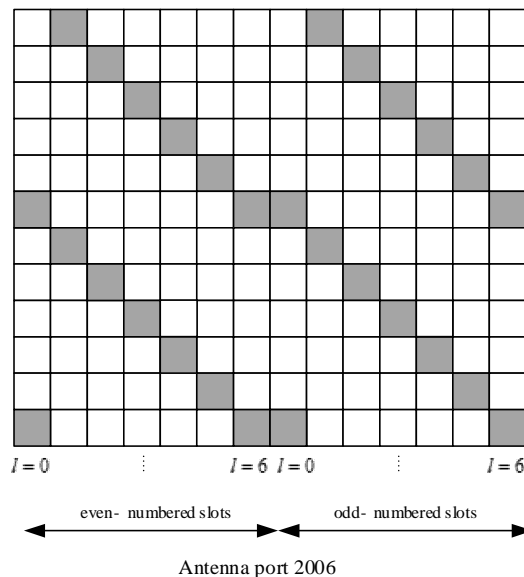

Figure 10.2.6A.2-2: Mapping of NPRS (*operationModeInfoNPRS* is set to standalone or guard-band, *nprsBitmap* configured)

10.2.6A.3 NPRS subframe configuration

On a NB-IoT DL carrier configured for NPRS transmission, an NB-IoT UE can assume NPRSs are transmitted in DL subframes configured by all higher layer parameters *nprsBitmap*, the NB-IoT carrier-specific subframe configuration period T_{NPRS} , the NB-IoT-carrier-specific starting subframe offset α_{NPRS} , and the number of consecutive downlink subframes N_{NPRS} where NPRS shall be transmitted. If frame structure type 2 is used, the UE shall not assume NPRSs are transmitted in special subframes.

- If T_{NPRS} , α_{NPRS} , and N_{NPRS} are not configured for an NB-IoT downlink carrier configured for NPRS transmission, an NB-IoT UE shall assume NPRSs are transmitted in downlink subframes configured by higher layer parameter *nprsBitmap*.

- If $nprsBitmap$ is not configured for an NB-IoT downlink carrier configured for NPRS transmission, an NB-IoT UE shall assume NPRSs are transmitted in downlink subframes configured by the higher layer parameters T_{NPRS} , α_{NPRS} , and N_{NPRS} .
- If the higher layer parameter $operationModeInfoNPRS$ for the configured NB-IoT carrier is set to in-band, the higher layer parameters $nprsBitmap$ shall be configured.
- If T_{NPRS} , α_{NPRS} , and N_{NPRS} are configured, the NPRS instances in the first subframe of the N_{NPRS} downlink subframes, shall satisfy $(10n_f + \lfloor n_s / 2 \rfloor - \alpha_{NPRS} T_{NPRS}) \bmod T_{NPRS} = 0$.

The NPRSs shall not be mapped to resource elements (k, l) allocated to resource blocks of NPBCH, NPSS, NSSS, or *SystemInformationBlock-Type1-NB* regardless of their antenna port p .

10.2.6B Narrowband wake up signal (NWUS)

10.2.6B.1 Sequence generation

The NWUS sequence $w(m)$ in subframe $x = 0, 1, \dots, M - 1$ is defined by

$$w(m) = \theta_{n_f, n_s}(m') \cdot e^{-\frac{j\pi u n(n+1)}{131}} e^{\frac{j2\pi g m}{132}}$$

$$m = 0, 1, \dots, 131$$

$$m' = m + 132x$$

$$n = m \bmod 132$$

$$\theta_{n_f, n_s}(m') = \begin{cases} 1, & \text{if } c_{n_f, n_s}(2m') = 0 \text{ and } c_{n_f, n_s}(2m' + 1) = 0 \\ -1, & \text{if } c_{n_f, n_s}(2m') = 0 \text{ and } c_{n_f, n_s}(2m' + 1) = 1 \\ j, & \text{if } c_{n_f, n_s}(2m') = 1 \text{ and } c_{n_f, n_s}(2m' + 1) = 0 \\ -j, & \text{if } c_{n_f, n_s}(2m') = 1 \text{ and } c_{n_f, n_s}(2m' + 1) = 1 \end{cases}$$

$$u = (N_{ID}^{Ncell} \bmod 126) + 3$$

where M is the actual duration of NWUS as defined in [4]. For a UE not configured with group NWUS, $g = 0$. For a UE configured with group NWUS, $g = 14(N_{group}^{NWUS} + 1)$ for $0 \leq N_{group}^{NWUS} \leq 7$, where N_{group}^{NWUS} is determined by the UE group to which the UE is associated as determined by higher layers [10]. In a resource that is not shared with non-group NWUS, the common NWUS sequence shall be determined by $g = 126$. In a resource that is shared with non-group NWUS, the common NWUS sequence is determined by higher layers [9].

The scrambling sequence $c_{n_f, n_s}(i)$, $i = 0, 1, \dots, 2 \cdot 132M - 1$ is given by clause 7.2, and shall be initialized at the start of the NWUS with

$$c_{init_WUS} = (N_{ID}^{Ncell} + 1) \left(\left((10n_{f_start_PO} + \lfloor \frac{n_{s_start_PO}}{2} \rfloor) \bmod 2048 + 1 \right) 2^9 + N_{ID}^{Ncell} + N_{ID}^{resource} \cdot 2^{29} \right)$$

where $n_{f_start_PO}$ is the first frame of the first PO to which the NWUS is associated, $n_{s_start_PO}$ is the first slot of the first PO to which the NWUS is associated and $N_{ID}^{resource}$ indicates the group NWUS resource to which the UE is associated. For a UE not configured with group NWUS, $N_{ID}^{resource} = 0$, whereas for a UE configured with group NWUS, $N_{ID}^{resource}$ is determined by higher layers [10].

10.2.6B.2 Mapping to resource elements

The same antenna port shall be used for all symbols of the NWUS within a subframe. The UE shall not assume that the NWUS is transmitted on the same antenna port as any of the downlink reference signals or synchronization signals. If only one NRS port is configured by the eNB, the UE may assume the transmission of all NWUS subframes is using the same antenna port; otherwise, the UE may assume the same antenna port is used for NWUS transmission in DL subframes $w0+2n$ and $w0+2n+1$, where $w0$ is the first DL subframe of the NWUS transmission as specified in [4], and $n=0,1,\dots$

The NWUS sequence is mapped to the set of subframes in the actual NWUS duration as defined in [4], where in a subframe #4 in which *SystemInformationBlockType1-NB* is transmitted or a subframe in which an SI message is transmitted, the subframe is counted in the NWUS mapping but not used for transmission of NWUS. On an NB-IoT carrier for which a UE receives higher-layer parameter *operationModeInfo* indicating *inband-SamePCI*, *inband-DifferentPCI*, *guardband* or *standalone* or on an NB-IoT carrier for which *DL-CarrierConfigCommon-NB* is present, the NWUS sequence $w(m)$ shall be mapped to resource elements (k, l) in sequence, starting with $w(0)$ in increasing order of first the index $k = 0, 1, \dots, N_{sc}^{RB} - 1$, over the 12 assigned subcarriers and then the index $l = 3, 4, \dots, 2N_{\text{ymb}}^{\text{DL}} - 1$ in each subframe in which NWUS is transmitted.

Additionally, on an NB-IoT carrier for which a UE receives higher-layer parameter *operationModeInfo* indicating *guardband* or *standalone*, or on an NB-IoT carrier for which *DL-CarrierConfigCommon-NB* is present and no *inbandCarrierInfo* is present, the resource mapping for the first three OFDM symbols in the subframe is performed as follows:

- The resource element $(k, 7)$ is mapped to resource element $(k, 0)$ of every index k over 12 assigned subcarriers
- The resource element $(k, 8)$ is mapped to resource element $(k, 1)$ of every index k over 12 assigned subcarriers
- The resource element $(k, 9)$ is mapped to resource element $(k, 2)$ of every index k over 12 assigned subcarriers

A resource element (k, l) overlapping with resource elements where cell-specific reference signals according to clause 6.10 are transmitted or NRSs according to clause 10.2.6 are transmitted shall not be used for NWUS transmission but is counted in the mapping process.

10.2.7 Synchronization signals

There are 504 unique physical-layer cell identities indicated by the narrowband secondary synchronization signal.

10.2.7.1 Narrowband primary synchronization signal (NPSS)

10.2.7.1.1 Sequence generation

The sequence $d_l(n)$ used for the narrowband primary synchronization signal is generated from a frequency-domain Zadoff-Chu sequence according to

$$d_l(n) = S(l) \cdot e^{-j \frac{\pi u n(n+1)}{11}}, \quad n = 0, 1, \dots, 10$$

where the Zadoff-Chu root sequence index $u=5$ and $S(l)$ for different symbol indices l is given by Table 10.2.7.1.1-1.

Table 10.2.7.1.1-1: Definition of $S(l)$.

Cyclic prefix length	$S(3), \dots, S(13)$										
Normal	1	1	1	1	-1	-1	1	1	1	-1	1

10.2.7.1.2 Mapping to resource elements

The same antenna port shall be used for all symbols of the narrowband primary synchronization signal within a subframe.

UE shall not assume that the narrowband primary synchronization signal is transmitted on the same antenna port as any of the downlink reference signals. The UE shall not assume that the transmissions of the narrowband primary synchronization signal in a given subframe use the same antenna port, or ports, as the narrowband primary synchronization signal in any other subframe.

The sequences $d_l(n)$ shall be mapped to resource elements (k, l) in increasing order of first the index

$k = 0, 1, \dots, N_{sc}^{RB} - 2$ and then the index $l = 3, 4, \dots, 2N_{\text{ymb}}^{\text{DL}} - 1$ in subframe 5 in every radio frame. For resource elements

If indicated by higher layer, a UE may assume different precoders are applied for NSSS transmission in a number of consecutive NSSS occasions signalled by higher layer.

The sequence $d(n)$ shall be mapped to resource elements (k, l) in sequence starting with $d(0)$ in increasing order of first the index k over the 12 assigned subcarriers and then the index l over the assigned last $N_{\text{symb}}^{\text{NSSS}}$ symbols of subframe 9 for frame structure type 1 or subframe 0 for frame structure type 2 in radio frames fulfilling $n_f \bmod 2 = 0$, where $N_{\text{symb}}^{\text{NSSS}}$ is given by Table 10.2.7.2.2-1.

Table 10.2.7.2.2-1: NSSS number of symbols

Cyclic prefix length	$N_{\text{symb}}^{\text{NSSS}}$
Normal	11

For resource elements (k, l) overlapping with resource elements where cell-specific reference signals according to clause 6.10 are transmitted, the corresponding sequence element $d(n)$ is not used for the NSSS but counted in the mapping process.

10.2.8 OFDM baseband signal generation

For an NB-IoT carrier

- for which the higher layer parameter *operationModeInfo* indicates 'inband-DifferentPCI' and for all NB-IoT downlink physical channels and signals except NPRS,
- for which the higher layer parameter *operationModeInfo* indicates 'Guardband' or 'Standalone',
- for an NB-IoT carrier for which the higher layer parameter *CarrierConfigDedicated-NB* or *DL-CarrierConfigCommon-NB* is present and no *inbandCarrierInfo* is present, or
- for an NB-IoT carrier for which the higher layer parameters *CarrierConfigDedicated-NB* or *DL-CarrierConfigCommon-NB* is present and *inbandCarrierInfo* is present and the higher layers do not indicate $N_{\text{ID}}^{\text{Ncell}}$ is the same as $N_{\text{ID}}^{\text{cell}}$ and for all NB-IoT downlink physical channels and signals except NPRS,

the time-continuous signal $s_l^{(p)}(t)$ on antenna port p in OFDM symbol l in a downlink slot is defined by

$$s_l^{(p)}(t) = \sum_{k=-\lfloor N_{\text{sc}}^{\text{RB}}/2 \rfloor}^{\lfloor N_{\text{sc}}^{\text{RB}}/2 \rfloor - 1} a_{k^{(-)}, l}^{(p)} \cdot e^{j2\pi(k+1/2)\Delta f(t - N_{\text{CP}, l} T_s)}$$

for $0 \leq t < (N_{\text{CP}, l} + N) \times T_s$ where $k^{(-)} = k + \lfloor N_{\text{sc}}^{\text{RB}}/2 \rfloor$, $N = 2048$, $\Delta f = 15$ kHz and $a_{k, l}^{(p)}$ is the content of resource element (k, l) on antenna port p .

Otherwise, the time-continuous signal $s_{l'}^{(p)}(t)$ on antenna port p in OFDM symbol l' , where

$l' = l + N_{\text{symb}}^{\text{DL}}(n_s \bmod 4) \in \{0, \dots, 27\}$ is the OFDM symbol index from the start of the last even-numbered subframe, is defined by

$$s_{l'}^{(p)}(t) = \sum_{k=-\lfloor N_{\text{RB}}^{\text{DL}} N_{\text{sc}}^{\text{RB}}/2 \rfloor}^{-1} e^{\theta_{k^{(-)}, l'}} a_{k^{(-)}, l'}^{(p)} \cdot e^{j2\pi k \Delta f \left(t - N_{\text{CP}, l' \bmod N_{\text{symb}}^{\text{DL}}} T_s \right)} + \sum_{k=1}^{\lfloor N_{\text{RB}}^{\text{DL}} N_{\text{sc}}^{\text{RB}}/2 \rfloor} e^{\theta_{k^{(+)}, l'}} a_{k^{(+)}, l'}^{(p)} \cdot e^{j2\pi k \Delta f \left(t - N_{\text{CP}, l' \bmod N_{\text{symb}}^{\text{DL}}} T_s \right)}$$

for $0 \leq t < (N_{\text{CP}, l'} + N) \times T_s$ where $k^{(-)} = k + \lfloor N_{\text{RB}}^{\text{DL}} N_{\text{sc}}^{\text{RB}}/2 \rfloor$ and $k^{(+)} = k + \lfloor N_{\text{RB}}^{\text{DL}} N_{\text{sc}}^{\text{RB}}/2 \rfloor - 1$,

$\theta_{k, l'} = j2\pi f_{\text{NB-IoT}} T_s \left(l' N + \sum_{i=0}^{l'} N_{\text{CP}, i \bmod 7} \right)$ if resource element (k, l') is used for Narrowband IoT except for NPRS, and

0 otherwise including NPRS. The quantity $f_{\text{NB-IoT}}$ is the frequency location of the center of the Narrowband IoT PRB minus the frequency location of the center of the LTE signal.

Only normal CP is supported for Narrowband IoT downlink in this release of the specification.

10.2.9 Modulation and upconversion

Modulation and upconversion to the carrier frequency of the complex-valued OFDM baseband signal for each antenna port is shown in Figure 6.13-1. The filtering required prior to transmission is defined by the requirements in 3GPP TS 36.104 [6].

Annex A (informative): Change history

Change history							
Date	TSG #	TSG Doc.	CR	Rev	Subject/Comment	Old	New
2006-09-24	-	-	-		Draft version created	-	0.0.0
2006-10-09	-	-	-		Updated skeleton	0.0.0	0.0.1
2006-10-13	-	-	-		Endorsed by RAN1	0.0.1	0.1.0
2006-10-23	-	-	-		Inclusion of decision from RAN1#46bis	0.1.0	0.1.1
2006-11-06	-	-	-		Updated editor 's version	0.1.1	0.1.2
2006-11-09	-	-	-		Updated editor 's version	0.1.2	0.1.3
2006-11-10	-	-	-		Endorsed by RAN1#47	0.1.3	0.2.0
2006-11-27	-	-	-		Editor 's version, including decisions from RAN1#47	0.2.0	0.2.1
2006-12-14	-	-	-		Updated editor 's version	0.2.1	0.2.2
2007-01-15	-	-	-		Updated editor 's version	0.2.2	0.2.3
2007-01-19	-	-	-		Endorsed by RAN1#47bis	0.2.3	0.3.0
2007-02-01	-	-	-		Editor 's version, including decisions from RAN1#47bis	0.3.0	0.3.1
2007-02-12	-	-	-		Updated editor 's version	0.3.1	0.3.2
2007-02-16	-	-	-		Endorsed by RAN1#48	0.3.2	0.4.0
2007-02-16	-	-	-		Editor 's version, including decisions from RAN1#48	0.4.0	0.4.1
2007-02-21	-	-	-		Updated editor 's version	0.4.1	0.4.2
2007-03-03	RP_35	RP-070169			For information at RAN#35	0.4.2	1.0.0
2007-04-25	-	-	-		Editor 's version, including decisions from RAN1#48bis and RAN1 TDD Ad Hoc	1.0.0	1.0.1
2007-05-03	-	-	-	-	Updated editor 's version	1.0.1	1.0.2
2007-05-08	-	-	-	-	Updated editor 's version	1.0.2	1.0.3
2007-05-11	-	-	-	-	Updated editor 's version	1.0.3	1.0.4
2007-05-11	-	-	-	-	Endorsed by RAN1#49	1.0.4	1.1.0
2007-05-15	-	-	-	-	Editor 's version, including decisions from RAN1#49	1.1.0	1.1.1
2007-06-05	-	-	-	-	Updated editor 's version	1.1.1	1.1.2
2007-06-25	-	-	-	-	Endorsed by RAN1#49bis	1.1.2	1.2.0
2007-07-10	-	-	-	-	Editor 's version, including decisions from RAN1#49bis	1.2.0	1.2.1
2007-08-10	-	-	-	-	Updated editor 's version	1.2.1	1.2.2
2007-08-20	-	-	-	-	Updated editor 's version	1.2.2	1.2.3
2007-08-24	-	-	-	-	Endorsed by RAN1#50	1.2.3	1.3.0
2007-08-27	-	-	-	-	Editor 's version, including decisions from RAN1#50	1.3.0	1.3.1
2007-09-05	-	-	-	-	Updated editor 's version	1.3.1	1.3.2
2007-09-08	RP_37	RP-070729	-	-	For approval at RAN#37	1.3.2	2.0.0
12/09/07	RP_37	RP-070729			Approved version	2.0.0	8.0.0
28/11/07	RP_38	RP-070949	0001	-	Introduction of optimized FS2 for TDD	8.0.0	8.1.0
28/11/07	RP_38	RP-070949	0002	-	Introduction of scrambling sequences, uplink reference signal sequences, secondary synchronization sequences and control channel processing	8.0.0	8.1.0
05/03/08	RP_39	RP-080219	0003	1	Update of uplink reference-signal hopping, downlink reference signals, scrambling sequences, DwPTS/UpPTS lengths for TDD and control channel processing	8.1.0	8.2.0
28/05/08	RP_40	RP-080432	0004	-	Correction of the number of subcarriers in PUSCH transform precoding	8.2.0	8.3.0
28/05/08	RP_40	RP-080432	0005	-	Correction of PHICH mapping	8.2.0	8.3.0
28/05/08	RP_40	RP-080432	0006	-	Correction of PUCCH resource index for PUCCH format 2	8.2.0	8.3.0
28/05/08	RP_40	RP-080432	0007	3	Correction of the predefined hopping pattern for PUSCH	8.2.0	8.3.0
28/05/08	RP_40	RP-080432	0008	-	Non-binary hashing functions	8.2.0	8.3.0
28/05/08	RP_40	RP-080432	0009	1	PUCCH format 1	8.2.0	8.3.0
28/05/08	RP_40	RP-080432	0010	1	CR on Uplink DM RS hopping	8.2.0	8.3.0
28/05/08	RP_40	RP-080432	0012	1	Correction to limitation of constellation size of ACK transmission in PUSCH	8.2.0	8.3.0
28/05/08	RP_40	RP-080432	0015	1	PHICH mapping for one and two antenna ports in extended CP	8.2.0	8.3.0
28/05/08	RP_40	RP-080432	0016	1	Correction of PUCCH in absent of mixed format	8.2.0	8.3.0
28/05/08	RP_40	RP-080432	0017	-	Specification of CCE size and PHICH resource indication	8.2.0	8.3.0
28/05/08	RP_40	RP-080432	0018	3	Correction of the description of frame structure type 2	8.2.0	8.3.0
28/05/08	RP_40	RP-080432	0019	-	On Delta ^{upucch} _shift correction	8.2.0	8.3.0
28/05/08	RP_40	RP-080432	0021	-	Corrections to Secondary Synchronization Signal Mapping	8.2.0	8.3.0
28/05/08	RP_40	RP-080432	0022	-	Downlink VRB mapping to PRB for distributed transmission	8.2.0	8.3.0
28/05/08	RP_40	RP-080432	0023	-	Clarification of modulation symbols to REs mapping for DVRB	8.2.0	8.3.0
28/05/08	RP_40	RP-080432	0024	1	Consideration on the scrambling of PDSCH	8.2.0	8.3.0
28/05/08	RP_40	RP-080432	0025	-	Corrections to Initialization of DL RS Scrambling	8.2.0	8.3.0
28/05/08	RP_40	RP-080432	0026	1	CR on Downlink RS	8.2.0	8.3.0

Change history							
Date	TSG #	TSG Doc.	CR	Rev	Subject/Comment	Old	New
28/05/08	RP_40	RP-080432	0027	-	CR on Uplink RS	8.2.0	8.3.0
28/05/08	RP_40	RP-080432	0028	1	Fixed timing advance offset for LTE TDD and half-duplex FDD	8.2.0	8.3.0
28/05/08	RP_40	RP-080432	0029	1	Timing of random access preamble format 4	8.2.0	8.3.0
28/05/08	RP_40	RP-080432	0030	1	Uplink sounding RS bandwidth configuration	8.2.0	8.3.0
28/05/08	RP_40	RP-080432	0031	-	Use of common RS when UE-specific RS are configured	8.2.0	8.3.0
28/05/08	RP_40	RP-080432	0032	1	Uplink RS Updates	8.2.0	8.3.0
28/05/08	RP_40	RP-080432	0033	-	Orthogonal cover sequence for shortened PUCCH format 1a and 1b	8.2.0	8.3.0
28/05/08	RP_40	RP-080432	0034	-	Clarification of PDCCH mapping	8.2.0	8.3.0
28/05/08	RP_40	RP-080432	0035	-	TDD PRACH time/frequency mapping	8.2.0	8.3.0
28/05/08	RP_40	RP-080432	0036	-	Cell Specific Uplink Sounding RS Subframe Configuration	8.2.0	8.3.0
28/05/08	RP_40	RP-080432	0038	-	PDCCH length for carriers with mixed MBSFN and Unicast Traffic	8.2.0	8.3.0
28/05/08	RP_40	RP-080432	0040	-	Correction to the scrambling sequence generation for PUCCH, PCFICH, PHICH, MBSFN RS and UE specific RS	8.2.0	8.3.0
28/05/08	RP_40	RP-080432	0041	-	PDCCH coverage in narrow bandwidths	8.2.0	8.3.0
28/05/08	RP_40	RP-080432	0042	-	Closed-Loop and Open-Loop Spatial Multiplexing	8.2.0	8.3.0
28/05/08	RP_40	RP-080432	0043	-	Removal of small-delay CDD	8.2.0	8.3.0
09/09/08	RP_41	RP-080668	48	1	Frequency Shifting of UE-specific RS	8.3.0	8.4.0
09/09/08	RP_41	RP-080668	49	1	Correction of PHICH to RE mapping in extended CP subframe	8.3.0	8.4.0
09/09/08	RP_41	RP-080668	50	-	Corrections to for handling remaining Res	8.3.0	8.4.0
09/09/08	RP_41	RP-080668	51	-	PRACH configuration for frame structure type 1	8.3.0	8.4.0
09/09/08	RP_41	RP-080668	52	2	Correction of PUCCH index generation formula	8.3.0	8.4.0
09/09/08	RP_41	RP-080668	53	-	Orthogonal cover sequence for shortened PUCCH format 1a and 1b	8.3.0	8.4.0
09/09/08	RP_41	RP-080668	54	-	Correction of mapping of ACK/NAK to binary bit values	8.3.0	8.4.0
09/09/08	RP_41	RP-080668	56	2	Remaining issues on SRS hopping	8.3.0	8.4.0
09/09/08	RP_41	RP-080668	57	1	Correction of $n_{cs}(n_s)$ and OC/CS remapping for PUCCH formats 1/1a/1b and 2/2a/2b	8.3.0	8.4.0
09/09/08	RP_41	RP-080668	59	-	Corrections to Rank information scrambling in Uplink Shared Channel	8.3.0	8.4.0
09/09/08	RP_41	RP-080668	60	-	Definition on the slot number for frame structure type 2	8.3.0	8.4.0
09/09/08	RP_41	RP-080668	61	-	Correction of the Npucch sequence upper limit for the formats 1/1a/1b	8.3.0	8.4.0
09/09/08	RP_41	RP-080668	62	1	Clarifications for DMRS parameters	8.3.0	8.4.0
09/09/08	RP_41	RP-080668	63	-	Correction of n_{prs}	8.3.0	8.4.0
09/09/08	RP_41	RP-080668	64	1	Introducing missing L1 parameters to 36.211	8.3.0	8.4.0
09/09/08	RP_41	RP-080668	65	3	Clarification on reception of synchronization signals	8.3.0	8.4.0
09/09/08	RP_41	RP-080668	66	-	Correction to the downlink/uplink timing	8.3.0	8.4.0
09/09/08	RP_41	RP-080668	67	-	ACK/NAK Scrambling scheme on PUCCH	8.3.0	8.4.0
09/09/08	RP_41	RP-080668	68	-	DCI format1C	8.3.0	8.4.0
09/09/08	RP_41	RP-080668	69	-	Refinement for REG Definition for $n = 4$	8.3.0	8.4.0
09/09/08	RP_41	RP-080668	71	-	Correcting Ncs value for PRACH preamble format 0-3	8.3.0	8.4.0
09/09/08	RP_41	RP-080668	73	-	Correction of the half duplex timing advance offset value	8.3.0	8.4.0
09/09/08	RP_41	RP-080668	74	-	Correction to Precoding for Transmit Diversity	8.3.0	8.4.0
09/09/08	RP_41	RP-080668	75	-	Clarification on number of OFDM symbols used for PDCCH	8.3.0	8.4.0
09/09/08	RP_41	RP-080668	77	-	Number of antenna ports for PDSCH	8.3.0	8.4.0
09/09/08	RP_41	RP-080668	78	-	Correction to Type 2 PUSCH predetermined hopping for $N_{sb}=1$ operation	8.3.0	8.4.0
09/09/08	RP_41	RP-080668	79	-	PRACH frequency location	8.3.0	8.4.0
03/12/08	RP_42	RP-081074	70	1	Correction for the definition of UE-specific reference signals	8.4.0	8.5.0
03/12/08	RP_42	RP-081074	72	2	Corrections to precoding for large delay CDD	8.4.0	8.5.0
03/12/08	RP_42	RP-081074	80	-	Correction to the definition of n_{bar_oc} for extended CP	8.4.0	8.5.0
03/12/08	RP_42	RP-081074	81	1	Specification of reserved REs not used for RS	8.4.0	8.5.0
03/12/08	RP_42	RP-081074	82	2	Clarification of the random access preamble transmission timing	8.4.0	8.5.0
03/12/08	RP_42	RP-081074	83	1	Indexing of PRACH resources within the radio frame	8.4.0	8.5.0
03/12/08	RP_42	RP-081074	84	6	Alignment of RAN1/RAN2 specification	8.4.0	8.5.0
03/12/08	RP_42	RP-081074	86	-	Clarification on scrambling of ACK/NAK bits for PUCCH format 2a/2b	8.4.0	8.5.0
03/12/08	RP_42	RP-081074	87	-	Correction of introduction of shortened SR	8.4.0	8.5.0
03/12/08	RP_42	RP-081074	88	-	Corrections to 36.211	8.4.0	8.5.0
03/12/08	RP_42	RP-081074	89	-	Clarification on PUSCH DM RS Cyclic Shift Hopping	8.4.0	8.5.0
03/12/08	RP_42	RP-081074	92	1	Correction to the uplink DM RS assignment	8.4.0	8.5.0
03/12/08	RP_42	RP-081074	93	-	Clarify the RNTI used in scrambling sequence initialization	8.4.0	8.5.0
03/12/08	RP_42	RP-081074	94	1	On linkage Among UL Power Control Parameters	8.4.0	8.5.0
03/12/08	RP_42	RP-081074	95	-	Clarification on PUSCH pre-determined hopping pattern	8.4.0	8.5.0
03/12/08	RP_42	RP-081074	96	-	Clarification of SRS sequence-group and base sequence number	8.4.0	8.5.0
03/12/08	RP_42	RP-081074	97	1	SRS subframe configuration	8.4.0	8.5.0
03/12/08	RP_42	RP-081074	98	-	Remaining SRS details for TDD	8.4.0	8.5.0
03/12/08	RP_42	RP-081074	99	-	Clarifying UL VRB Allocation	8.4.0	8.5.0

Change history							
Date	TSG #	TSG Doc.	CR	Rev	Subject/Comment	Old	New
03/12/08	RP_42	RP-081074	100	-	Clarification on PUCCH resource hopping	8.4.0	8.5.0
03/12/08	RP_42	RP-081074	101	-	Correction for definition of Qm and a pseudo code syntax error in Scrambling.	8.4.0	8.5.0
03/12/08	RP_42	RP-081074	105	1	Remaining Issues on SRS of TDD	8.4.0	8.5.0
03/12/08	RP_42	RP-081074	106	-	Correction of reference to RAN4 specification of supported uplink bandwidth	8.4.0	8.5.0
03/12/08	RP_42	RP-081074	107	-	General corrections to SRS	8.4.0	8.5.0
03/12/08	RP_42	RP-081074	109	2	Correction to PCFICH specification	8.4.0	8.5.0
03/12/08	RP_42	RP-081074	110	1	Correction to Layer Mapping for Transmit Diversity with Four Antenna Ports	8.4.0	8.5.0
03/12/08	RP_42	RP-081074	111	-	Correction of the mapping of cyclic shift filed in DCI format 0 to the dynamic cyclic shift offset	8.4.0	8.5.0
03/12/08	RP_42	RP-081074	112	-	DRS collision handling	8.4.0	8.5.0
03/12/08	RP_42	RP-081074	113	-	Clarification to enable reuse of non-active PUCCH CQI RBs for PUSCH	8.4.0	8.5.0
03/12/08	RP_42	RP-081074	114	1	PUSCH Mirror Hopping operation	8.4.0	8.5.0
03/12/08	RP_42	RP-081074	108	1	Extended and normal cyclic prefix in DL and UL for LTE TDD	8.4.0	8.5.0
04/03/09	RP_43	RP-090234	115	1	Alignment of PRACH configuration index for FS type 1 and type 2	8.5.0	8.6.0
04/03/09	RP_43	RP-090234	118	1	Clarification for DRS Collision handling	8.5.0	8.6.0
04/03/09	RP_43	RP-090234	121	1	Removing inverse modulo operation	8.5.0	8.6.0
04/03/09	RP_43	RP-090234	123	1	Clarification on the use of preamble format 4	8.5.0	8.6.0
04/03/09	RP_43	RP-090234	124	-	Clarification of RNTI used in scrambling sequence	8.5.0	8.6.0
04/03/09	RP_43	RP-090234	125	1	Clarifying PDCCH RE mapping	8.5.0	8.6.0
04/03/09	RP_43	RP-090234	126	-	Correction of preamble format 4 timing	8.5.0	8.6.0
04/03/09	RP_43	RP-090234	127	2	Corrections to SRS	8.5.0	8.6.0
04/03/09	RP_43	RP-090234	128	2	Clarification of PDSCH Mapping to Resource Elements	8.5.0	8.6.0
04/03/09	RP_43	RP-090234	129	1	Alignment with correct ASN1 parameter names	8.5.0	8.6.0
04/03/09	RP_43	RP-090234	130	-	Correction to PUCCH format 1 mapping to physical resources	8.5.0	8.6.0
04/03/09	RP_43	RP-090234	132	-	Correction to type-2 PUSCH hopping	8.5.0	8.6.0
04/03/09	RP_43	RP-090234	134	-	Alignment of SRS configuration	8.5.0	8.6.0
27/05/09	RP_44	RP-090527	135	-	Correction on UE behavior for PRACH 20ms periodicity	8.6.0	8.7.0
15/09/09	RP_45	RP-090888	137	1	Clarification on DMRS sequence for PUSCH	8.7.0	8.8.0
15/09/09	RP_45	RP-090888	138	1	Correction to PHICH resource mapping for TDD and to PHICH scrambling	8.7.0	8.8.0
01/12/09	RP_46	RP-091168	142	-	Clarification of the transmit condition for UE specific reference signals	8.8.0	8.9.0
01/12/09	RP_46	RP-091172	139	2	Introduction of LTE positioning	8.9.0	9.0.0
01/12/09	RP_46	RP-091177	140	3	Editorial corrections to 36.211	8.9.0	9.0.0
01/12/09	RP_46	RP-091257	141	1	Introduction of enhanced dual layer transmission	8.9.0	9.0.0
16/03/10	RP_47	RP-100209	144	1	Removal of square brackets on positioning subframe periodicities	9.0.0	9.1.0
16/03/10	RP_47	RP-100209	145	-	Clarification of the CP length of empty OFDM symbols in PRS subframes	9.0.0	9.1.0
16/03/10	RP_47	RP-100210	146	-	Clarification of MBSFN subframe definition	9.0.0	9.1.0
07/12/10	RP_50	RP-101320	148	-	Introduction of Rel-10 LTE-Advanced features in 36.211	9.1.0	10.0.0
15/03/11	RP_51	RP-110254	149	1	Correction on UE behavior for PRACH preamble format 4	10.0.0	10.1.0
15/03/11	RP_51	RP-110256	150	-	Corrections to Rel-10 LTE-Advanced features in 36.211	10.0.0	10.1.0
01/06/11	RP_52	RP-110818	153	2	PUSCH interaction with periodic SRS	10.1.0	10.2.0
01/06/11	RP_52	RP-110819	154	1	Correction on describing PUCCH format 3	10.1.0	10.2.0
01/06/11	RP_52	RP-110821	155	3	Correction on codebooks for CSI-RS based feedback for up to 4 CSI-RS ports.	10.1.0	10.2.0
01/06/11	RP_52	RP-110821	156	-	Correction on overlapping non-zero-power and zero-power CSI-RS configurations	10.1.0	10.2.0
01/06/11	RP_52	RP-110821	157	-	Correction on CSI-RS configuration	10.1.0	10.2.0
01/06/11	RP_52	RP-110821	158	-	PDSCH transmission in MBSFN subframes	10.1.0	10.2.0
01/06/11	RP_52	RP-110823	159	-	Correction on implicit derivation of transmission comb per antenna port for SRS	10.1.0	10.2.0
01/06/11	RP_52	RP-110823	160	-	Uplink DMRS sequence in RACH procedure	10.1.0	10.2.0
15/09/11	RP_53	RP-111229	162	-	Corrections on DMRS for Extended CP	10.2.0	10.3.0
15/09/11	RP_53	RP-111228	163	-	Clarification of applicability of precoding power scaling factors for PDSCH	10.2.0	10.3.0
15/09/11	RP_53	RP-111228	164	-	Correction to modulation and upconversion on PRACH	10.2.0	10.3.0
15/09/11	RP_53	RP-111229	165	-	Clarification on cyclic prefix of PDSCH in MBSFN subframes	10.2.0	10.3.0
15/09/11	RP_53	RP-111229	166	3	Corrections on indication in scrambling identity field in DCI format 2B and 2C	10.2.0	10.3.0
05/12/11	RP_54	RP-111668	167	-	A correction to PDSCH precoding for CQI calculation	10.3.0	10.4.0
05/12/11	RP_54	RP-111668	168	-	Correction to figure of CSI-RS pattern in extended-CP subframe	10.3.0	10.4.0
13/06/12	RP_56	RP-120736	169	-	Correction to resource mapping for PDSCH	10.4.0	10.5.0
13/06/12	RP_56	RP-120739	171	-	Correction for DMRS group hopping and sequence hopping	10.4.0	10.5.0
13/06/12	RP_56	RP-120738	172	-	Correction to assumed CSI-RS transmissions in subframes used for paging	10.4.0	10.5.0

Change history							
Date	TSG #	TSG Doc.	CR	Rev	Subject/Comment	Old	New
04/09/12	RP_57	RP-121274	170	4	Introduction of an additional special subframe configuration	10.5.0	11.0.0
04/09/12	RP_57	RP-121272	173	-	Inclusion of Rel-11 features	10.5.0	11.0.0
04/12/12	RP_58	RP-121839	175	-	Correction to assumed CSI-RS transmissions in secondary cells	11.0.0	11.1.0
04/12/12	RP_58	RP-121846	176	-	Correction to assumed CSI-RS transmissions in secondary cells	11.0.0	11.1.0
26/02/13	RP_59	RP-130254	178	-	Clarification of CSI RS mapping to resource elements	11.1.0	11.2.0
26/02/13	RP_59	RP-130254	180	-	Correction to CSI Reference Signals	11.1.0	11.2.0
26/02/13	RP_59	RP-130255	181	-	Additional clarifications/corrections for introducing Rel-11 features	11.1.0	11.2.0
11/06/13	RP_60	RP-130752	182	-	Correction to EPDCCH PRB pair indication	11.2.0	11.3.0
11/06/13	RP_60	RP-130752	183	-	CR on collision between EPDCCH and PSS/SSS/PBCH	11.2.0	11.3.0
03/09/13					MCC clean-up	11.3.0	11.4.0
03/09/13	RP_60	RP-131250	185	-	Correction to QCL behaviour on CRS	11.3.0	11.4.0
03/12/13	RP_62	RP-131894	186	-	Correction on the derivation of the non-MBSFN region by PCFICH	11.4.0	11.5.0
03/12/13	RP_62	RP-131896	184	3	Introduction of Rel 12 feature for Downlink MIMO Enhancement	11.5.0	12.0.0
03/03/14	RP_63	RP-140286	187	-	On PMCH starting symbol in an MBSFN subframe	12.0.0	12.1.0
10/06/14	RP_64	RP-140858	189	-	CR on antenna port definitions	12.1.0	12.2.0
10/06/14	RP_64	RP-140858	190	1	Clarification of downlink subframes	12.1.0	12.2.0
10/06/14	RP_64	RP-140862	191	-	Inclusion of eIMTA, TDD-FDD CA, and coverage enhancements	12.1.0	12.2.0
10/09/14	RP_65	RP-141485	192	-	Inclusion of low-cost MTC and 256QAM	12.2.0	12.3.0
10/09/14	RP_65	RP-141477	194	-	CR on port 5 UE-specific reference signal when PDSCH is overlapped with EPDCCH	12.2.0	12.3.0
08/12/14	RP_66	RP-142098	195	3	Clarification of PUSCH rate matching with SRS	12.3.0	12.4.0
08/12/14	RP_66	RP-142106	197	4	Inclusion of small-cell enhancements	12.3.0	12.4.0
09/03/15	RP_67	RP-150366	196	7	Inclusion of ProSe	12.4.0	12.5.0
09/03/15	RP_67	RP-150364	198	-	Correction on 256QAM applicability to PMCH	12.4.0	12.5.0
09/03/15	RP_67	RP-150364	199	-	Correction of discovery signal transmission	12.4.0	12.5.0
15/06/15	RP_68	RP-150935	201	-	Alignment of ProSe parameters	12.5.0	12.6.0
14/09/15	RP_69	RP-151465	203	-	Clarification on SRS BW configuration	12.6.0	12.7.0
07/12/15	RP_70	RP-152036	209	1	Modify max TA for dual connectivity	12.7.0	12.8.0
07/12/15	RP_70	RP-152025	206	2	Introduction of EB/FD-MIMO	12.8.0	13.0.0
07/12/15	RP_70	RP-152027	208	1	Introduction of Rel-13 eCA	12.8.0	13.0.0
07/12/15	RP_70	RP-152125	204	2	eD2D CR for 36.211	12.8.0	13.0.0
07/12/15	RP_70	RP-152258	205	4	Introduction of LAA	12.8.0	13.0.0

Change history							
Date	Meeting	TDoc	CR	Rev	Cat	Subject/Comment	New version
2016-03	RAN#71	RP-160359	210	-	F	Alignment eD2D CR for 36.211	13.1.0
2016-03	RAN#71	RP-160367	212	-	F	Clarification on PDSCH collision with PSS/SSS/PBCH	13.1.0
2016-03	RAN#71	RP-160357	213	-	F	Correction on support of CA with up to 32 CCs	13.1.0
2016-03	RAN#71	RP-160357	214	-	F	Correction on PUCCH format 4 and 5	13.1.0
2016-03	RAN#71	RP-160360	217	-	F	Correction on DRS subframe in 36.211	13.1.0
2016-03	RAN#71	RP-160360	218	-	F	Correction on EPDCCH start symbol in LAA	13.1.0
2016-03	RAN#71	RP-160360	219	-	F	Correction to MBSFN subframe configuration	13.1.0
2016-03	RAN#71	RP-160358	220	-	F	CR on CSI-RS configuration for more than eight antenna ports in 36.211	13.1.0
2016-03	RAN#71	RP-160358	221	-	F	CR on mismatch between 36.211 and 36.331	13.1.0
2016-03	RAN#71	RP-160358	222	-	F	Clarification on additional SC-FDMA symbols in UpPTS for SRS	13.1.0
2016-03	RAN#71	RP-160358	223	-	F	Correction on Precoding and definition of DMRS ports	13.1.0
2016-03	RAN#71	RP-160361	207	9	B	Introduction of LC/CE MTC	13.1.0
2016-06	RAN#72	RP-161063	216	2	F	CR on CSI-RS transmission in DwPTS	13.2.0
2016-06	RAN#72	RP-161067	224	8	B	Introduction of NB-IoT	13.2.0
2016-06	RAN#72	RP-161066	229	2	F	Collision between PSS/SSS/PBCH and MPDCCH/PDSCH for MTC	13.2.0
2016-06	RAN#72	RP-161066	230	-	F	DMRS initialization of CSS for MTC	13.2.0
2016-06	RAN#72	RP-161066	231	-	F	Missing words in PRACH starting subframe paragraph for MTC	13.2.0
2016-06	RAN#72	RP-161065	232	-	F	Correction to EPDCCH procedures for LAA FS 3	13.2.0
2016-06	RAN#72	RP-161063	233	-	F	Clarification on PDSCH mapping to resource elements	13.2.0
2016-06	RAN#72	RP-161063	234	-	F	CR on CSI-RS description in TS 36.211	13.2.0
2016-06	RAN#72	RP-161065	235	-	F	Corrections on the support of ending partial subframe in LAA	13.2.0
2016-06	RAN#72	RP-161063	236	-	F	Clarification of CSI-RS on extended CP	13.2.0
2016-06	RAN#72	RP-161063	237	-	F	Correction on description about UpPTS length for preamble format 4 for PRACH	13.2.0
2016-06	RAN#72	RP-161066	238	-	F	Correction to TS 36.211 for eMTC	13.2.0
2016-06	RAN#72	RP-161066	239	-	F	Narrow band hopping	13.2.0
2016-06	RAN#72	RP-161066	240	1	F	CR on MPDCCH format for R _{max} =1 and 2/4 PRBs	13.2.0
2016-06	RAN#72	RP-161066	241	1	F	Correction on RE mapping in MBSFN subframe for BL/CE UEs in CEModeB	13.2.0
2016-06	RAN#72	RP-161063	242	-	F	Correction on the description about DMRS	13.2.0
2016-06	RAN#72	RP-161066	243	-	F	CR for TS36.211 related to 2+4 PRB set	13.2.0
2016-06	RAN#72	RP-161065	244	-	F	CR on UE assumptions on number of CRS ports in DRS	13.2.0
2016-06	RAN#72	RP-161066	245	-	F	Some corrections for eMTC	13.2.0
2016-06	RAN#72	RP-161066	247	-	F	Clarification of MPDCCH over empty CRS tones in PBCH repetition	13.2.0
2016-06	RAN#72	RP-161066	248	-	F	Scrambling sequence initialization	13.2.0
2016-06	RAN#72	RP-161066	249	-	F	On MPDCCH AL for 8 EREGs per ECCE in TS 36.211	13.2.0
2016-06	RAN#72	RP-161066	250	-	F	Overriding of valid-invalid subframes for R=1	13.2.0
2016-06	RAN#72	RP-161066	251	-	F	Scrambling Sequence for paging MPDCCH and PDSCH	13.2.0

2016-06	RAN#72	RP-161066	252	-	F	Scrambling sequence initialization for PDSCH	13.2.0
2016-09	RAN#73	RP-161563	253	-	F	Correction on DMRS for NB-IoT in TS 36.211	13.3.0
2016-09	RAN#73	RP-161563	254	1	F	Correction on NPRACH in TS 36.211	13.3.0
2016-09	RAN#73	RP-161563	255	-	F	Correction on SC-FDMA signal generation for NB-IoT in TS 36.211	13.3.0
2016-09	RAN#73	RP-161563	256	-	F	Corrections to RRC parameter names for NB-IoT in TS 36.211	13.3.0
2016-09	RAN#73	RP-161562	259	-	F	MPDCCH search-space with Temporary C-RNTI	13.3.0
2016-09	RAN#73	RP-161563	260	-	F	Correction on NPBCH in TS 36.211	13.3.0
2016-09	RAN#73	RP-161563	261	1	F	Correction on UL collisions in TS 36.211	13.3.0
2016-09	RAN#73	RP-161563	262	1	F	Correction on NPSS mapping in TS 36.211	13.3.0
2016-09	RAN#73	RP-161563	263	1	F	Corrections on the presence of NRS for standalone and guard band operation mode in TS 36.211	13.3.0
2016-09	RAN#73	RP-161561	264	-	F	Correction on the determination of EPDCCH starting position	13.3.0
2016-09	RAN#73	RP-161563	265	-	F	Corrections on NPDCCH scrambling in TS 36.211	13.3.0
2016-09	RAN#73	RP-161562	272	1	F	Frequency hopping for SI and paging messages for BL/CE UE	13.3.0
2016-09	RAN#73	RP-161562	275	-	F	Scrambling of DL DMRS for BL/CE UE	13.3.0
2016-09	RAN#73	RP-161562	276	-	F	Enable cross-subframe channel estimation for BL/CE UE	13.3.0
2016-09	RAN#73	RP-161562	278	-	F	Frequency hopping interval for MPDCCH during random access for BL/CE UE	13.3.0
2016-09	RAN#73	RP-161565	279	-	F	CR on the correction from SC-FDFMA to SC-FDMA	13.3.0
2016-09	RAN#73	RP-161561	280	-	F	Correction for PHICH resource reservation on the LAA cell in 36.211 for Rel-13 LAA	13.3.0
2016-09	RAN#73	RP-161562	281	-	F	Correction on MPDCCH transmission without repetition in special subframes	13.3.0
2016-09	RAN#73	RP-161563	282	1	F	Introduction of a reserved range of NPRACH sub-carriers for contention based access	13.3.0
2016-09	RAN#73	RP-161562	283	-	F	Clarification of valid subframe in eMTC	13.3.0
2016-09	RAN#73	RP-161563	284	-	F	Correction of NB-IoT antenna port mapping	13.3.0
2016-09	RAN#73	RP-161562	285	-	F	Clarification on PRACH system frame number	13.3.0
2016-09	RAN#73	RP-161562	286	-	F	PUCCH retuning with puncturing for BL/CE UE	13.3.0
2016-09	RAN#73	RP-161563	287	1	F	Phase difference between NRS and CRS	13.3.0
2016-09	RAN#73	RP-161825	288	1	B	Continuous uplink transmission in eMTC	13.3.0
2016-09	RAN#73	RP-161571	266	2	B	Introduction of eLAA	14.0.0
2016-09	RAN#73	RP-161570	267	2	B	Introduction of V2V support	14.0.0
2016-12	RAN#74	RP-162368	0297	-	F	CR on start timing of PUSCH	14.1.0
2016-12	RAN#74	RP-162358	0298	-	A	Correction to DMRS for MPDCCH associated with P-RNTI – Rel-14	14.1.0
2016-12	RAN#74	RP-162359	0300	-	A	Clarification on NPRACH and NPUSCH collision	14.1.0
2016-12	RAN#74	RP-162358	0302	1	A	Clarification on i_0 value	14.1.0
2016-12	RAN#74	RP-162358	0304	-	A	Correction of PRACH starting subframes for eMTC	14.1.0
2016-12	RAN#74	RP-162359	0306	-	A	Correction of NPRACH frequency hopping	14.1.0
2016-12	RAN#74	RP-162358	0307	-	A	Correction on MPDCCH transmission without repetition	14.1.0
2016-12	RAN#74	RP-162358	0308	-	A	Correction of typos due to wrong implementation of CR0283 "Clarification of valid subframe in eMTC "	14.1.0
2016-12	RAN#74	RP-162356	0309	-	A	Correction on NZP CSI-RS aggregation for Class A	14.1.0

2016-12	RAN#74	RP-162367	0310	2	B	Introduction of performance enhancements for high speed scenario	14.1.0
2016-12	RAN#74	RP-162450	0311	-	B	Introduction of further indoor positioning enhancements	14.1.0
2016-12	RAN#74	RP-162365	0312	1	B	Introduction of Multiuser Superposition Transmission (MUST)	14.1.0
2016-12	RAN#74	RP-162359	0316	1	A	Correction on NPDSCH Mapping to resource elements in 36.211	14.1.0
2016-12	RAN#74	RP-162358	0320	-	A	UL gap applicability for CE Mode A	14.1.0
2016-12	RAN#74	RP-162355	0322	-	A	CR on pseudo-random sequence generator for PUCCH format 4 and PUCCH format 5 and sequence group hopping for PUCCH format 4	14.1.0
2016-12	RAN#74	RP-162359	0324	-	A	Clarification on vShift value for CRS	14.1.0
2016-12	RAN#74	RP-162359	0326	-	A	Correction to OFDM baseband signal generation of NB-IoT	14.1.0
2016-12	RAN#74	RP-162358	0327	-	A	Mapping of MPDCCH and PDSCH	14.1.0
2016-12	RAN#74	RP-162364	0328	-	B	Introduction of SRS switching between LTE component carriers	14.1.0
2016-12	RAN#74	RP-162366	0329	-	F	Corrections for V2V	14.1.0
2017-03	RAN#75	RP-170605	0330	1	B	Introduction of Uplink Capacity Enhancements for LTE	14.2.0
2017-03	RAN#75	RP-170608	0331	1	B	Introduction of eMBMS enhancements for LTE	14.2.0
2017-03	RAN#75	RP-170623	0332	2	B	Introduction of Further Enhanced MTC for LTE	14.2.0
2017-03	RAN#75	RP-170624	0333	3	B	Introduction of NB-IoT enhancements	14.2.0
2017-03	RAN#75	RP-170622	0334	2	B	Introduction of V2X	14.2.0
2017-03	RAN#75	RP-170607	0335	2	B	Introduction of eFD-MIMO	14.2.0
2017-03	RAN#75	RP-170625	0336	2	B	Introduction of Voice and Video enhancement for LTE	14.2.0
2017-03	RAN#75	RP-170610	0338	2	A	Correction on the scrambling of NPDSCH carrying the BCCH	14.2.0
2017-03	RAN#75	RP-170609	0340	-	A	Frequency hopping in eMTC	14.2.0
2017-03	RAN#75	RP-170609	0342	-	A	Retuning gap with shortened PUCCH format for BL/CE UE	14.2.0
2017-03	RAN#75	RP-170609	0344	-	A	Parameters for number of PUCCH repetitions for Msg4 for BL/CE UE – Superseded by CR0332r2	14.2.0
2017-03	RAN#75	RP-170609	0346	-	A	Clarification on repetition and starting subframe of the MPDCCH search space	14.2.0
2017-03	RAN#75	RP-170615	0347	-	F	CR for SRS switching in 36.211	14.2.0
2017-03	RAN#75	RP-170617	0348	-	F	CR on the new restricted sets of cyclic shifts for PRACH for high speed in 36.211	14.2.0
2017-03	RAN#75	RP-170612	0352	-	A	Correction on single layer precoding for EPCCH	14.2.0
2017-03	RAN#75	RP-170610	0354	-	A	NPBCH symbol rotation for interference randomization in NB-IoT	14.2.0
2017-03	RAN#75	RP-170617	0355	-	F	Correction to PRACH resource configuration for high speed scenario in TS 36.211	14.2.0
2017-06	RAN#76	RP-171205	0356	-	F	Correction on baseband generation for paging/random access non-anchor carriers	14.3.0
2017-06	RAN#76	RP-171204	0357	-	F	Correction of reference to PRS occasion group for OTDOA enhancements	14.3.0
2017-06	RAN#76	RP-171204	0358	-	F	Center frequency for PUSCH allocation in larger bandwidth mode in FeMTC	14.3.0
2017-06	RAN#76	RP-171205	0359	-	F	Clarification of NRS presence	14.3.0
2017-06	RAN#76	RP-171194	0360	-	F	Clarification and Correction on IFDMA UL-DMRS for eFD-MIMO	14.3.0
2017-06	RAN#76	RP-171199	0363	-	A	Clarification on PDSCH collision with PSS/SSS in TDD	14.3.0
2017-06	RAN#76	RP-171195	0364	-	F	Clarification on CDM-8 pattern for 24-ports CSI-RS in DwPTS	14.3.0
2017-06	RAN#76	RP-171192	0365	-	F	Correction on PUSCH symbol locations in UpPTS for UL capacity enhancement in TS 36.211	14.3.0
2017-06	RAN#76	RP-171196	0366	-	A	CR on correction of PRACH transmission across SFN boundary	14.3.0

2017-06	RAN#76	RP-171204	0367	-	F	Correction on resource mapping in case of retuning in 36.211	14.3.0
2017-06	RAN#76	RP-171197	0369	1	A	Correction on NB-IoT DMRS definition in 36.211	14.3.0
2017-06	RAN#76	RP-171197	0371	1	A	Correction on NB-IoT SC-FDMA baseband signal generation in 36.211	14.3.0
2017-06	RAN#76	RP-171197	0373	-	A	Clarification on the definition of the nprach-NumCBRA-StartSubcarriers	14.3.0
2017-06	RAN#76	RP-171204	0374	-	F	Parallel reception of MPDCCH and PDSCH for BL/CE UE	14.3.0
2017-06	RAN#76	RP-171194	0375	-	F	CR for precoding for spatial multiplexing using antenna ports with UE-specific reference signals in 36.211	14.3.0
2017-06	RAN#76	RP-171194	0376	-	F	Correction to CSI-RS configuration	14.3.0
2017-06	RAN#76	RP-171196	0378	-	A	Clarification of frequency hopping for "PDCCH order " initiated PUSCH	14.3.0
2017-06	RAN#76	RP-171196	0380	-	A	Correction on determination of number of repetitions PUCCH format 1	14.3.0
2017-06	RAN#76	RP-171204	0381	-	F	Correction on PRS hopping	14.3.0
2017-06	RAN#76	RP-171205	0383	-	F	NRS presence assumptions on unicast non-anchor carriers	14.3.0
2017-09	RAN#77	RP-171646	0384	-	F	Correction of RRC parameter name for non-anchor carriers	14.4.0
2017-09	RAN#77	RP-171638	0386	1	F	Corrections on CDM8 sequence for 24 and 32 CSI-RS ports and CDM4 sequence	14.4.0
2017-09	RAN#77	RP-171645	0387	-	F	PRS and PDSCH/MPDCCH collision	14.4.0
2017-09	RAN#77	RP-171640	0389	-	A	NPUSCH transmission during NPRACH gaps	14.4.0
2017-09	RAN#77	RP-171639	0391	-	A	MPDCCH Frequency hopping for RRC connected contention-based RACH	14.4.0
2017-09	RAN#77	RP-171646	0392	1	F	Interference randomization for NPDCCH and NPDSCH	14.4.0
2017-12	RAN#78	RP-172688	0395	-	A	Clarification on DMRS ports associated with PDSCH	14.5.0
2017-12	RAN#78	RP-172680	0396	-	A	Correction on MPDCCH frequency hopping	14.5.0
2017-12	RAN#78	RP-172685	0397	-	F	SRS to SRS retuning in UpPTS	14.5.0
2017-12	RAN#78	RP-172679	0398	-	F	Correction on power boosting for UL DMRS	14.5.0
2017-12	RAN#78	RP-172680	0402	-	A	Correction on scrambling sequence identity for 2+4 PRBs sets in MPDCCH	14.5.0
2017-12	RAN#78	RP-172680	0404	-	A	Correction on resource elements reserved for CRS for PBCH with repetition	14.5.0
2017-12	RAN#78	RP-172677	0405	-	F	Introduction of new UE behavior for special subframe configuration 10	14.5.0
2017-12	RAN#78	RP-172691	0406	-	F	Correction for PUSCH puncturing in SRS carrier switching	14.5.0
2017-12	RAN#78	RP-172679	0407	-	F	Correction on the scale factor for semi-OL rank-1	14.5.0
2017-12	RAN#78	RP-172680	0409	-	A	UE uplink gap capability signaling description	14.5.0
2017-12	RAN#78	RP-172693	0385	4	B	Introduction of shortened processing time and shortened TTI into 36.211, s03-05	15.0.0
2017-12	RAN#78	RP-172693	0399	2	B	Introduction of shortened processing time and shortened TTI into 36.211, s06-08	15.0.0
2018-03	RAN#79	RP-180195	0400	1	B	Introduction of feCoMP into 36.211	15.1.0
2018-03	RAN#79	RP-180191	0416	-	A	Clarification on the NPRACH starting subcarrier partitioning for multi-tone Msg3 transmission	15.1.0
2018-03	RAN#79	RP-180189	0418	-	A	Correction on CDM-8 Sequence Mapping for 24 and 32 ports	15.1.0
2018-03	RAN#79	RP-180190	0419	-	A	Clarification on PUSCH and PDSCH scrambling for BL/CE UEs	15.1.0
2018-03	RAN#79	RP-180190	0420	-	A	Clarification on the hopping parameter for PUSCH transmission corresponding to the RAR grant	15.1.0
2018-03	RAN#79	RP-180199	0422	-	A	Interference randomization in CSS	15.1.0
2018-03	RAN#79	RP-180187	0424	-	A	Correction on DM-RS in DwPTS in special subframe configuration 10	15.1.0
2018-03	RAN#79	RP-180191	0427	-	A	Clarification on NPDCCH RE mapping	15.1.0

2018-06	RAN#80	RP-181163	0430	1	A	Correction on DMRS scrambling ID for semi-open loop transmission	15.2.0
2018-06	RAN#80	RP-181173	0431	-	B	Introduction of enhancements for high capacity stationary wireless link and introduction of 1024 QAM for LTE	15.2.0
2018-06	RAN#80	RP-181169	0434	-	A	Correction on PUSCH hopping parameter for eVoLTE	15.2.0
2018-06	RAN#80	RP-181181	0437	-	A	Collision with NPRACH in non-anchor carriers	15.2.0
2018-06	RAN#80	RP-181181	0439	-	A	On NRS presence in non-anchor carriers	15.2.0
2018-06	RAN#80	RP-181170	0440	1	F	Corrections to sTTI and SPT implementation	15.2.0
2018-06	RAN#80	RP-181180	0441	1	B	Introduction of enhancements to operation in unlicensed spectrum	15.2.0
2018-06	RAN#80	RP-181167	0444	1	A	Clarification on CSI-RS resource aggregation	15.2.0
2018-06	RAN#80	RP-181174	0447	-	B	Introduction of Even Further Enhanced MTC for LTE	15.2.0
2018-06	RAN#80	RP-181166	0448	-	B	Introduction Rel-15 Further NB-IoT enhancements	15.2.0
2018-06	RAN#80	RP-181168	0449	-	F	Correction on layer-to-port mapping for feCoMP	15.2.0
2018-06	RAN#80	RP-181177	0450	-	B	Introduction of HRLLC into 36.211	15.2.0
2018-09	RAN#81	RP-181792	0451	-	B	Introduction of eV2X	15.3.0
2018-09	RAN#81	RP-181796	0453	-	A	Correction for interference randomization for NB-IoT	15.3.0
2018-09	RAN#81	RP-181796	0455	-	A	Correction to NPRS mapping	15.3.0
2018-09	RAN#81	RP-181795	0456	-	F	Correction on DL CP extension for FeLAA in 36.211	15.3.0
2018-09	RAN#81	RP-181795	0457	-	F	Correction to determination of ending symbol for AUL transmissions	15.3.0
2018-09	RAN#81	RP-181780	0459	-	A	Rate matching for aperiodic CSI-RS	15.3.0
2018-09	RAN#81	RP-181787	0460	-	F	Corrections to sTTI and SPT	15.3.0
2018-09	RAN#81	RP-181791	0461	-	F	Corrections to eMTC	15.3.0
2018-09	RAN#81	RP-181783	0462	-	F	Corrections to NB-IoT	15.3.0
2018-09	RAN#81	RP-181793	0463	-	F	Corrections to HRLLC	15.3.0
2018-12	RAN#82	RP-182518	0465	-	A	Correction on aperiodic CSI-RS resource mapping in 36.211	15.4.0
2018-12	RAN#82	RP-182518	0467	-	A	Correction to non-precoded NZP CSI-RS resource configurations	15.4.0
2018-12	RAN#82	RP-182524	0468	1	F	Corrections to LTE-MTC	15.4.0
2018-12	RAN#82	RP-182519	0469	1	F	Corrections to NB-IoT	15.4.0
2018-12	RAN#82	RP-182518	0471	-	A	Clarification on cyclic shift field mapping table for DMRS bit field in DCI format 0/4	15.4.0
2018-12	RAN#82	RP-182526	0472	-	F	Correction on rate-matching around SPDCCH resources for PDSCH repetition	15.4.0
2018-12	RAN#82	RP-182522	0473	-	F	Correction on the number of CCEs for DMRS-based SPDCCH	15.4.0
2018-12	RAN#82	RP-182522	0474	-	F	Correction of SPDCCH rate-matching description	15.4.0
2019-03	RAN#83	RP-190434	0476	-	F	Correction of higher layer signalling for special subframe configuration 10	15.5.0
2019-03	RAN#83	RP-190437	0477	-	F	DMRS sequence index for PUSCH sub-PRB allocation for LTE-MTC	15.5.0
2019-03	RAN#83	RP-190436	0478	-	F	CR on DMRS mapping for SPDCCH	15.5.0
2019-06	RAN#84	RP-191269	0479	-	F	Correction on NPRACH baseband signal generation	15.6.0
2019-06	RAN#84	RP-191270	0480	-	F	Handling of invalid PRB for frequency hopping of BL/CE UEs with PUSCH CE Mode A and flexible starting PRB	15.6.0
2019-06	RAN#84	RP-191272	0483	-	A	Correction for PUSCH frequency hopping in eMTC	15.6.0
2019-06	RAN#84	RP-191273	0485	-	A	Correction for PUSCH frequency hopping in VoLTE enhancements	15.6.0

2019-09	RAN#85	RP-191939	0487	-	F	Correction for PDSCH starting position in a subframe of FS3	15.7.0
2019-09	RAN#85	RP-191937	0490	-	A	Clarification on localized MPDCCH DMRS port for 2+4 PRB set	15.7.0
2019-09	RAN#85	RP-191945	0491	-	F	Correction on higher layer parameter configuring short TTI length in 36.211	15.7.0
2019-09	RAN#85	RP-191936	0492	-	F	Correction on DMRS for NPUSCH Format 2 in TDD NB-IoT	15.7.0
2019-12	RAN#86	RP-192620	0495	-	A	Clarification to postponing in subframes that are not BL/CE subframes	15.8.0
2019-12	RAN#86	RP-192618	0497	-	F	PUSCH frequency hopping configured with CEModeB and flexible starting PRB allocation	15.8.0
2019-12	RAN#86	RP-192618	0498	-	F	Correction of MWUS sequence generation	15.8.0
2019-12	RAN#86	RP-192632	0500	-	A	Correction on interference randomization on non-anchor carrier for NB-IoT	15.8.0
2019-12	RAN#86	RP-192647	0501	-	B	Introduction of additional MTC enhancements for LTE	16.0.0
2019-12	RAN#86	RP-192648	0502	-	B	Introduction of Additional enhancements for NB-IoT	16.0.0
2019-12	RAN#86	RP-192649	0503	-	B	Introduction of DL MIMO efficiency enhancements for LTE	16.0.0
2019-12	RAN#86	RP-192650	0504	-	B	Introduction of LTE terrestrial broadcast	16.0.0
2020-03	RAN#87-e	RP-200202	0507	-	A	Correction on the resource block pair definition for 1.25 kHz subcarrier spacing	16.1.0
2020-03	RAN#87-e	RP-200178	0509	-	A	Correction on Rel-15 NWUS/MWUS	16.1.0
2020-03	RAN#87-e	RP-200196	0510	-	F	Miscellaneous corrections for Rel-16 LTE-MTC features in 36.211	16.1.0
2020-03	RAN#87-e	RP-200197	0511	-	F	Miscellaneous corrections for Rel-16 NB-IoT features in 36.211	16.1.0
2020-03	RAN#87-e	RP-200199	0512	-	F	Corrections to LTE terrestrial broadcast	16.1.0
2020-03	RAN#87-e	RP-200198	0513	-	F	Corrections to DL MIMO efficiency enhancements for LTE	16.1.0
2020-06	RAN#88-e	RP-200704	0518	-	A	Correction on NRS presence in non-anchor carriers for NB-IoT	16.2.0
2020-06	RAN#88-e	RP-200681	0519	-	A	CR on WUS transmission in TDD special subframe	16.2.0
2020-06	RAN#88-e	RP-200681	0525	-	A	CR on clarification of RSS transmission	16.2.0
2020-06	RAN#88-e	RP-200681	0527	-	A	CR on scrambling initialization for sub-PRB PUSCH	16.2.0
2020-06	RAN#88-e	RP-200703	0532	-	A	Correction on MBSFN region start symbol index of a MBSFN subframe	16.2.0
2020-06	RAN#88-e	RP-200699	0533	-	F	Corrections for Rel-16 NB-IoT features in 36.211	16.2.0
2020-06	RAN#88-e	RP-200701	0534	1	F	Corrections to LTE terrestrial broadcast	16.2.0
2020-06	RAN#88-e	RP-200698	0535	-	F	Corrections to Rel-16 LTE-MTC features in 36.211	16.2.0
2020-06	RAN#88-e	RP-200700	0536	1	F	Corrections to DL MIMO efficiency enhancements for LTE	16.2.0

History

Document history		
V16.2.0	September 2020	Publication