

**nwmo**

NUCLEAR WASTE  
MANAGEMENT  
ORGANIZATION

SOCIÉTÉ DE GESTION  
DES DÉCHETS  
NUCLÉAIRES



# How will People and the Environment be Protected Now and in the Future

Erik Kremer  
Senior Engineer, Used Fuel Safety Assessment

# Safety and Repository Performance

## Presentation Overview

- What does Safety Assessment do?
- Components of the Repository and Engineered Barriers
  - Multiple-Barrier System
  - Natural Analogues
- Design and Proof-Testing for Engineered Barriers
  - Pressure Testing
  - Crush Testing
  - Bentonite Clay Technology

# Safety

‘**Safety**’ means protecting the public, the workers and the environment from hazards associated with facility operation

**In general, safety is achieved through a combination of:**

- Robust design that complies with all applicable standards
- Engineered barriers
- Trained staff and proper equipment
- A good site
- Favourable host rock
- Durable, non-reactive wasteform
- Repository depth
- Monitoring and oversight



**Safety** is determined (in part) by comparing estimated effects (doses) against approved acceptance criteria

If margins are deemed insufficient, key assumptions are examined and iteration with design and operations may occur to implement improvements

# Safety Case

The **Safety Case** is an integrated collection of arguments and evidence that together demonstrate the safety of the facility

The Safety Case addresses all aspects of safety:

- Conventional Health and Safety
- Transportation Safety
- Preclosure Safety
- Postclosure Safety

The portion addressing radiological safety will include a Safety Assessment, a Geosynthesis, information on R&D support, information on Natural Analogues and more

It will be subjected to peer review (national and international reviewers)

It will be subjected to independent review and checking by the CNSC

Licenses will not be granted until the CNSC is satisfied that the health and safety of the public, the workers and the environment are protected

# Safety Case

**Postclosure Safety Assessment** provides a quantitative estimate of the ability of the repository to isolate and contain the hazard posed by the used fuel in the long term

Uses computer models of the repository, the surrounding host rock and the biosphere

Follows guidance in CNSC REGDOC-2.11.1, Volume II 'Assessing the Long Term Safety of Radioactive Waste Management'

Considers

- The effects on people due to radiological and non-radiological hazards
- The effects on the environment due to radiological and non-radiological hazards

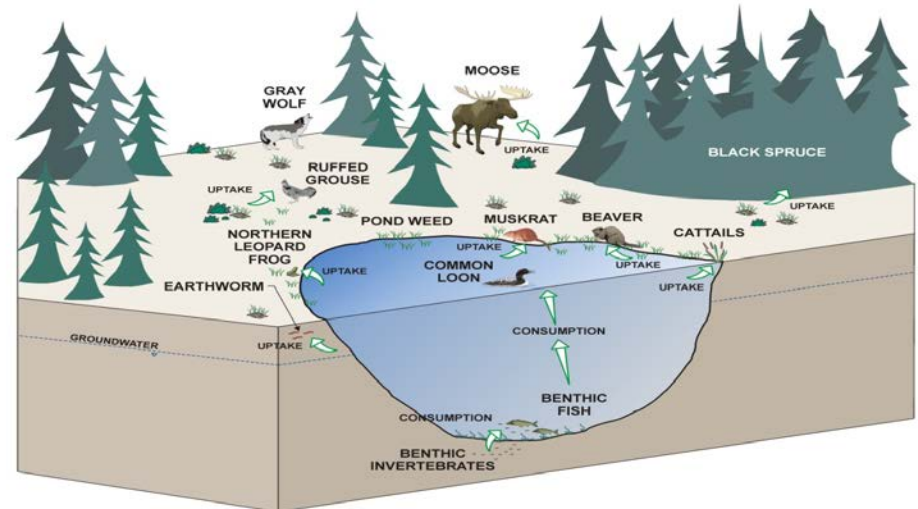

# Postclosure Safety Assessment

## Some Modelling Illustrations:

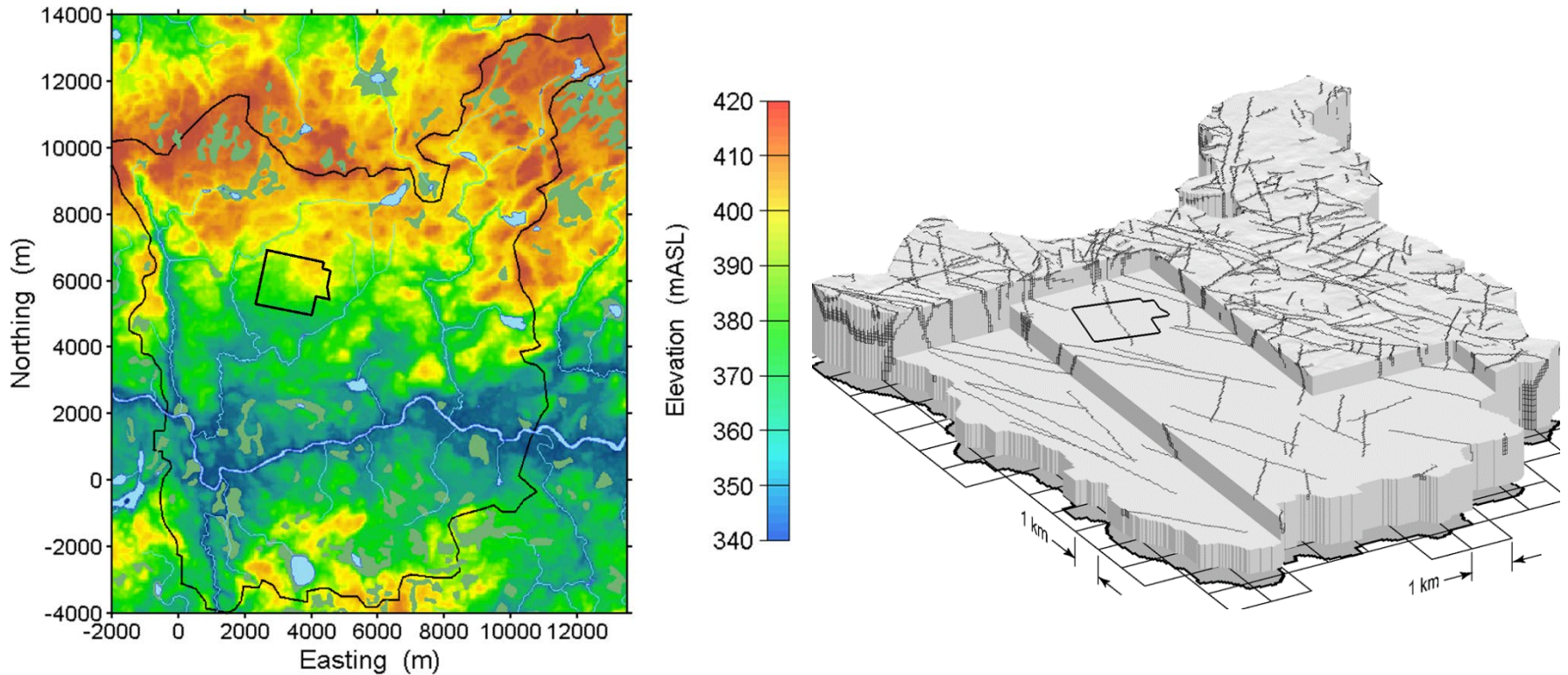

**Surface and Subsurface Model around Hypothetical Repository**

# Postclosure Safety Assessment

## Normal Evolution Scenario, Reference and Sensitivity Cases

- Reference Case
- Base Case
- Barrier Sensitivity Cases
  - Used Fuel (e.g., Fuel Dissolution Rate)
  - Zircaloy Sheath (e.g., Zircaloy Dissolution Rate)
  - Used Fuel Container (e.g., Times of Hypothetical Failures)
  - Engineered Sealing Materials (e.g., Conductivity, Sorption)
  - Geosphere (e.g., Fractures, Sorption)
- Bounding Assessments (e.g., No ESM Sorption)
- Probabilistic Assessments (Uncertainty Across Multiple Parameters)

# Postclosure Safety Assessment

## Very Unlikely Scenarios (which must be addressed in the Safety Case)

- Undetected Fault
- Failure of Borehole Seals
- Failure of Repository Seals
- Partially Sealed Repository
- Inadvertent Human Intrusion
- All containers fail simultaneously at 60,000 years postclosure

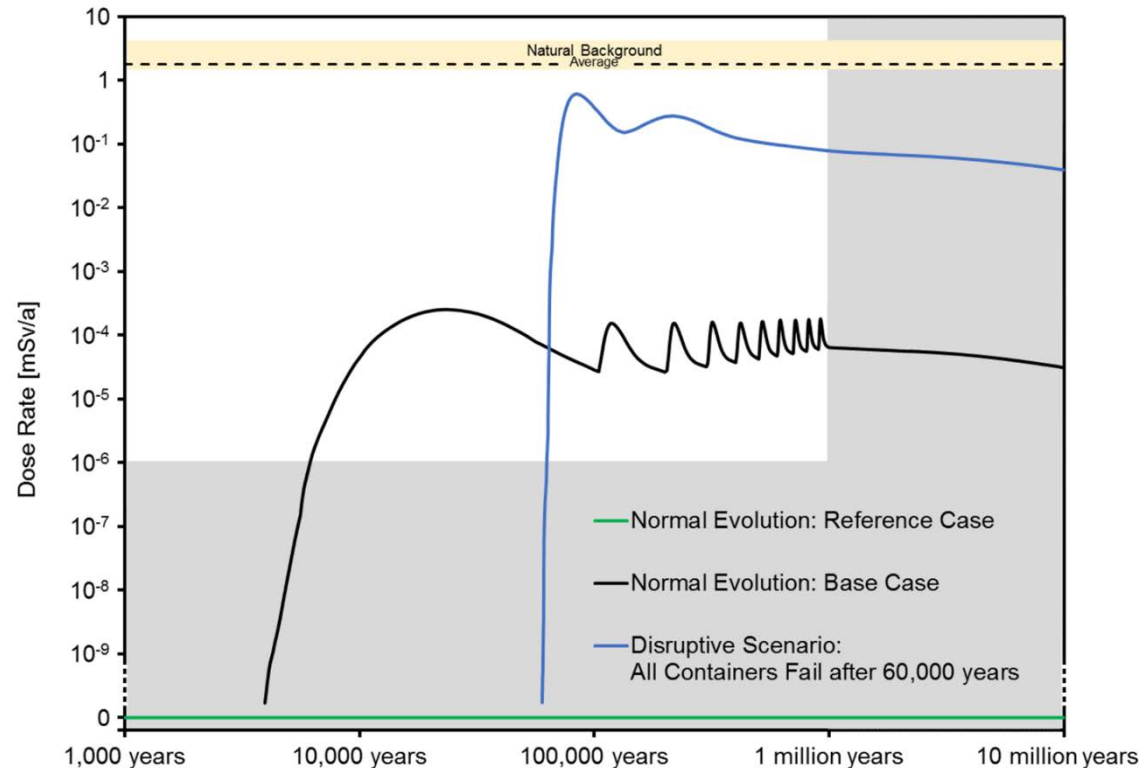



# APM Deep Geological Repository

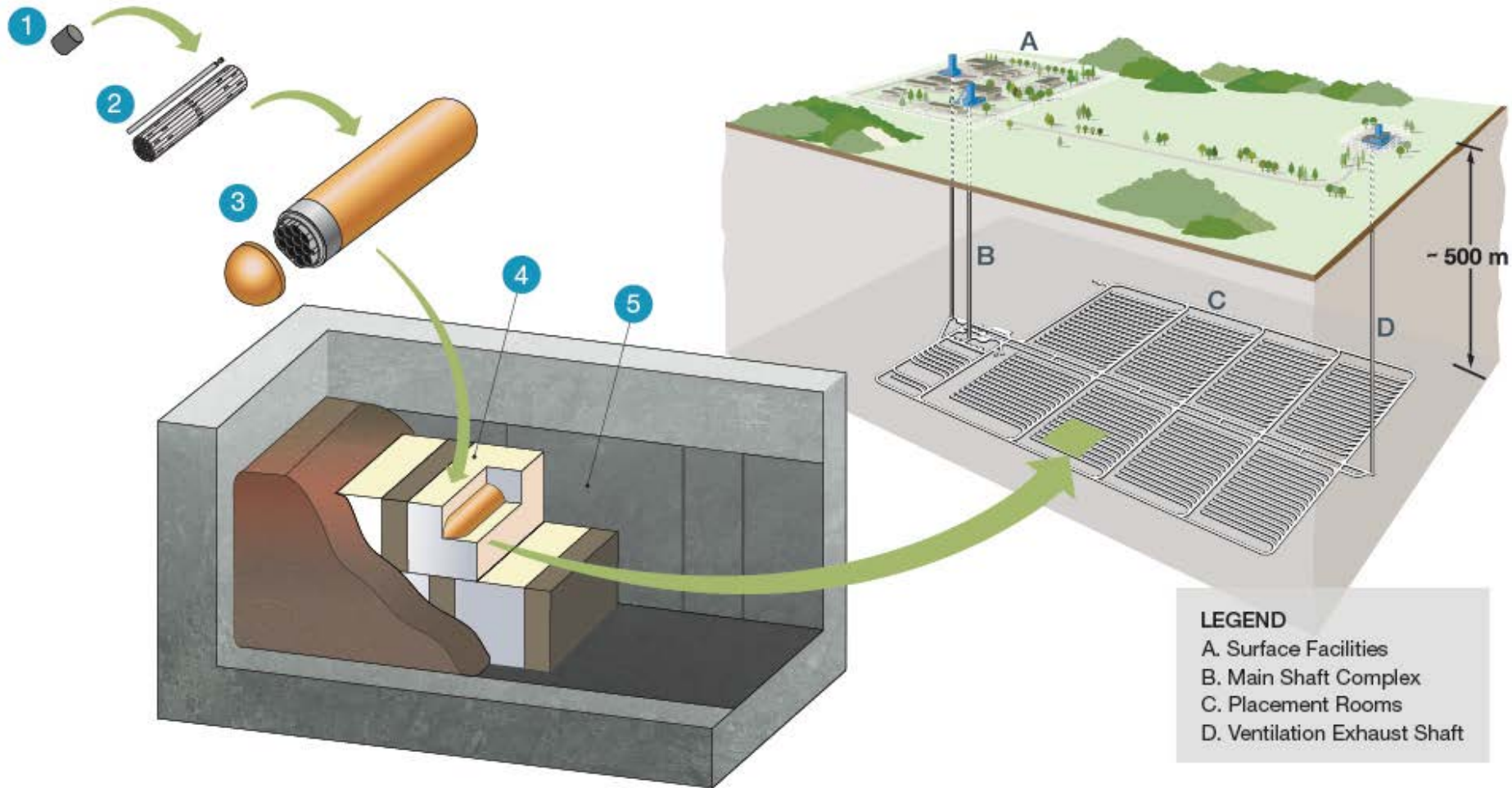

# Description of Repository and EBS Components

**Postclosure safety is achieved via a combination of overlapping engineered and natural barriers**

## **Purpose of the Barriers:**

- To prevent water from contacting the used fuel
- If water does contact the fuel, to inhibit and slow down the migration of contaminants to allow more time for radioactive decay

# Description of Repository and EBS Components

## Barriers :

- Fuel pellet
- Fuel sheath
- Used fuel container
- Clay based sealing materials
- Geosphere

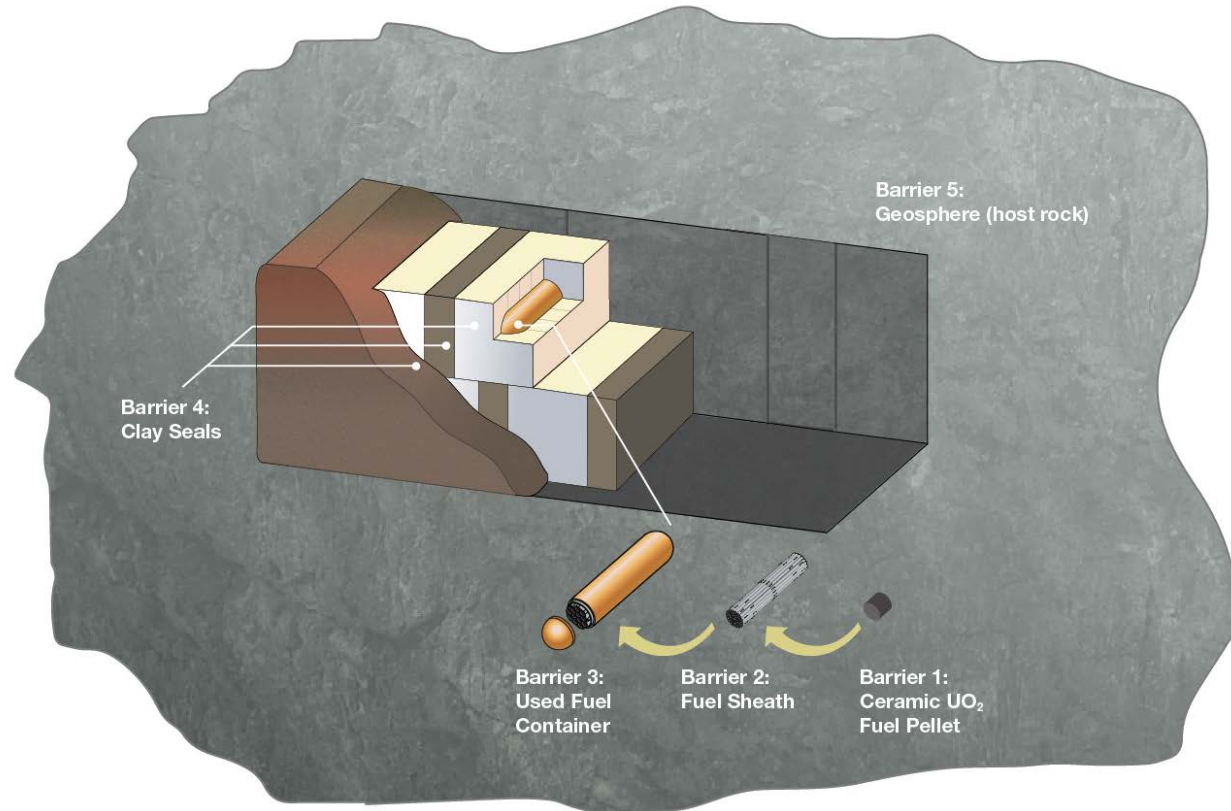

# Natural Analogues

## Postclosure Safety is Supported by Natural Analogues:

- These are natural features that exist under conditions or processes occurring over long periods of time that are similar to those expected in some part of a deep geological repository
- They build confidence that the system will perform as expected
- Analogues exist for all repository components

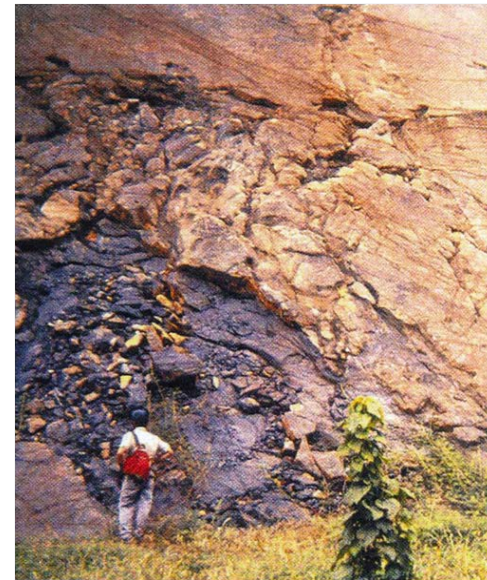
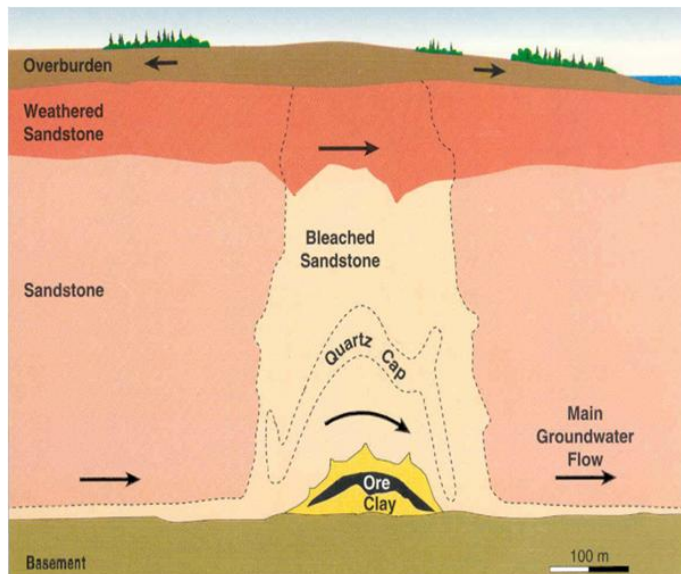

# Greenland Analogue Project

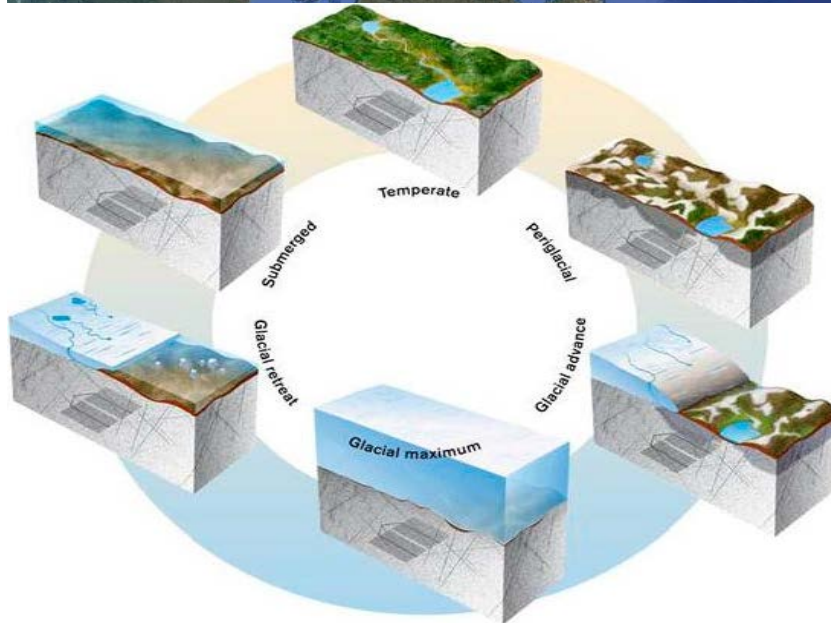

# Natural Analogue



# Natural Analogue



# Bentonite Clay





# APM Bentonite-Based Sealing Materials

- Containers encased in buffer boxes of highly compacted bentonite
- Remaining gaps filled with bentonite pellets
- Bentonite swells and seals against groundwater movement

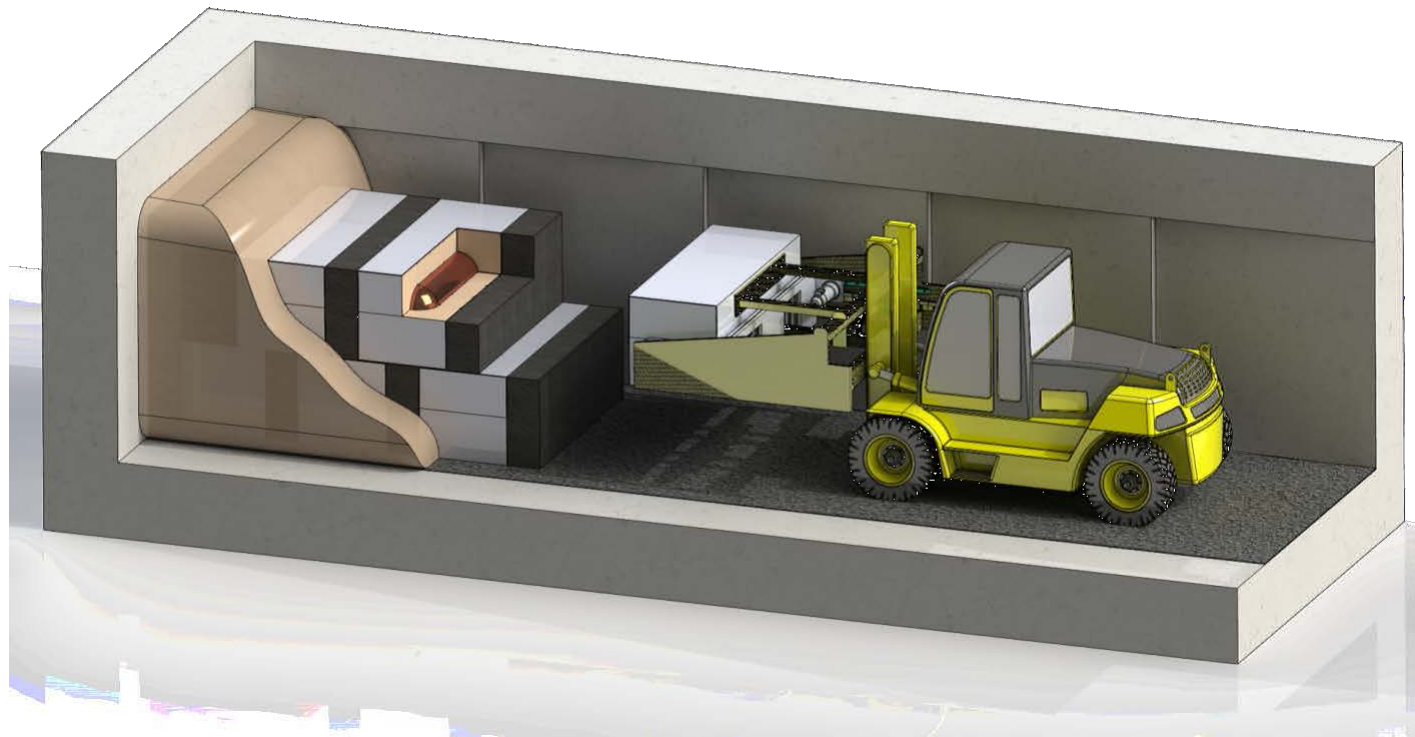

# APM Bentonite-Based Sealing Materials

## How Bentonite Supports Repository Performance

- Hold the used-fuel container in position
- Resist movement of groundwater
- Maintain suitable chemistry
- Suppress microbiology

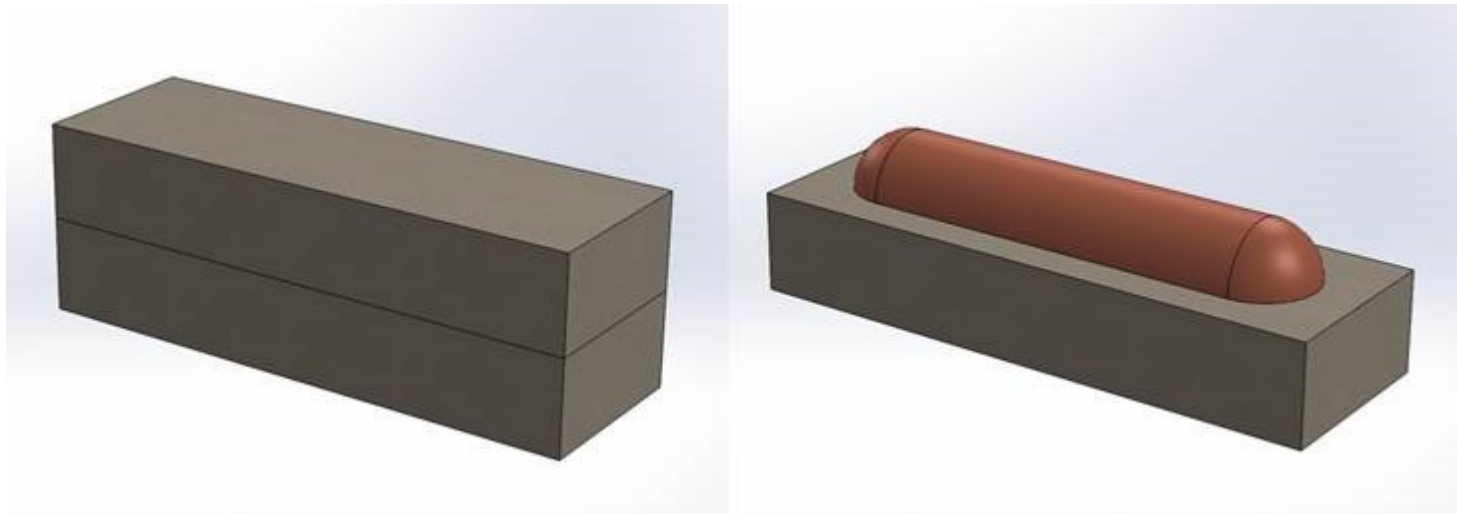

# APM Bentonite-Based Sealing Materials

## Substantial Research & Development ([www.nwmo.ca](http://www.nwmo.ca))

- Experimental characterization, international collaboration
- Data development, model calculations, simulations
- Large number of reports, journal publications, proceedings

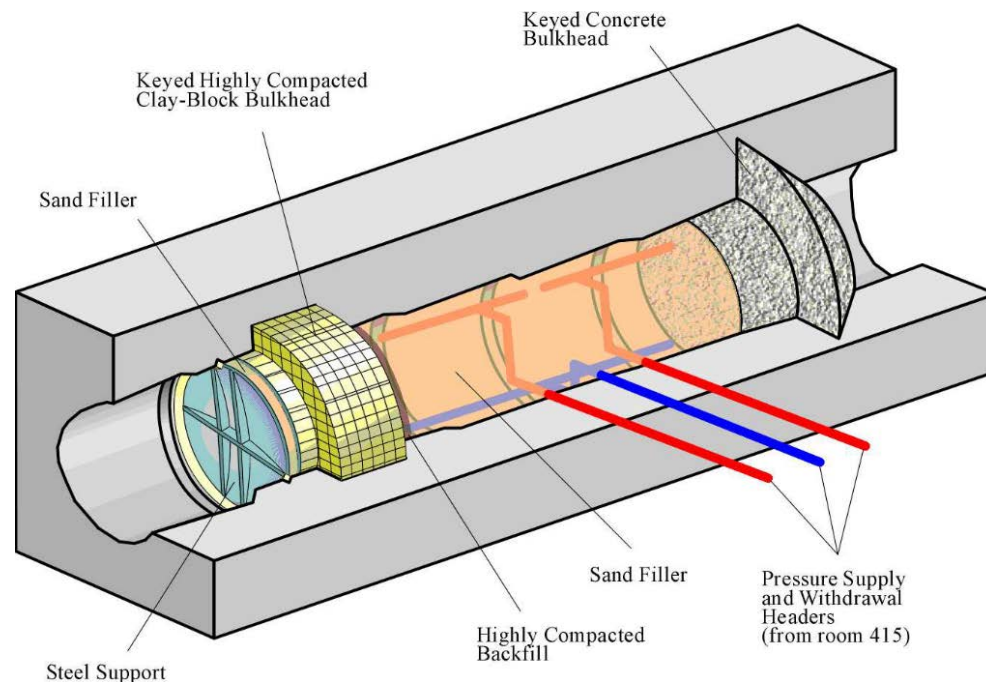

# APM Bentonite-Based Sealing Materials

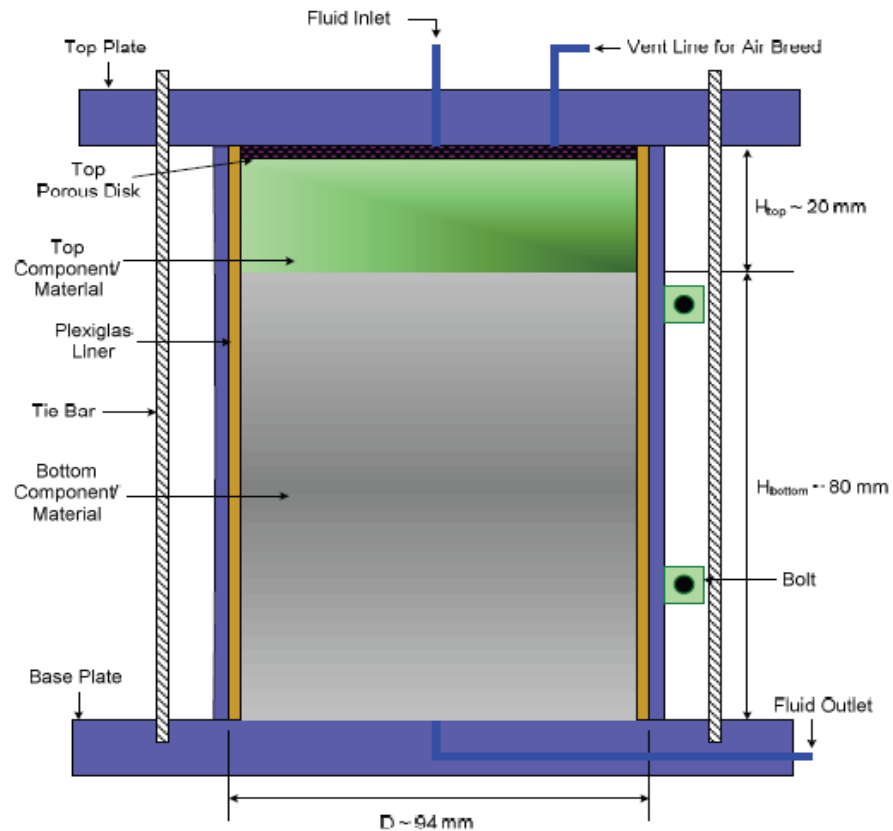

# APM Bentonite-Based Sealing Materials

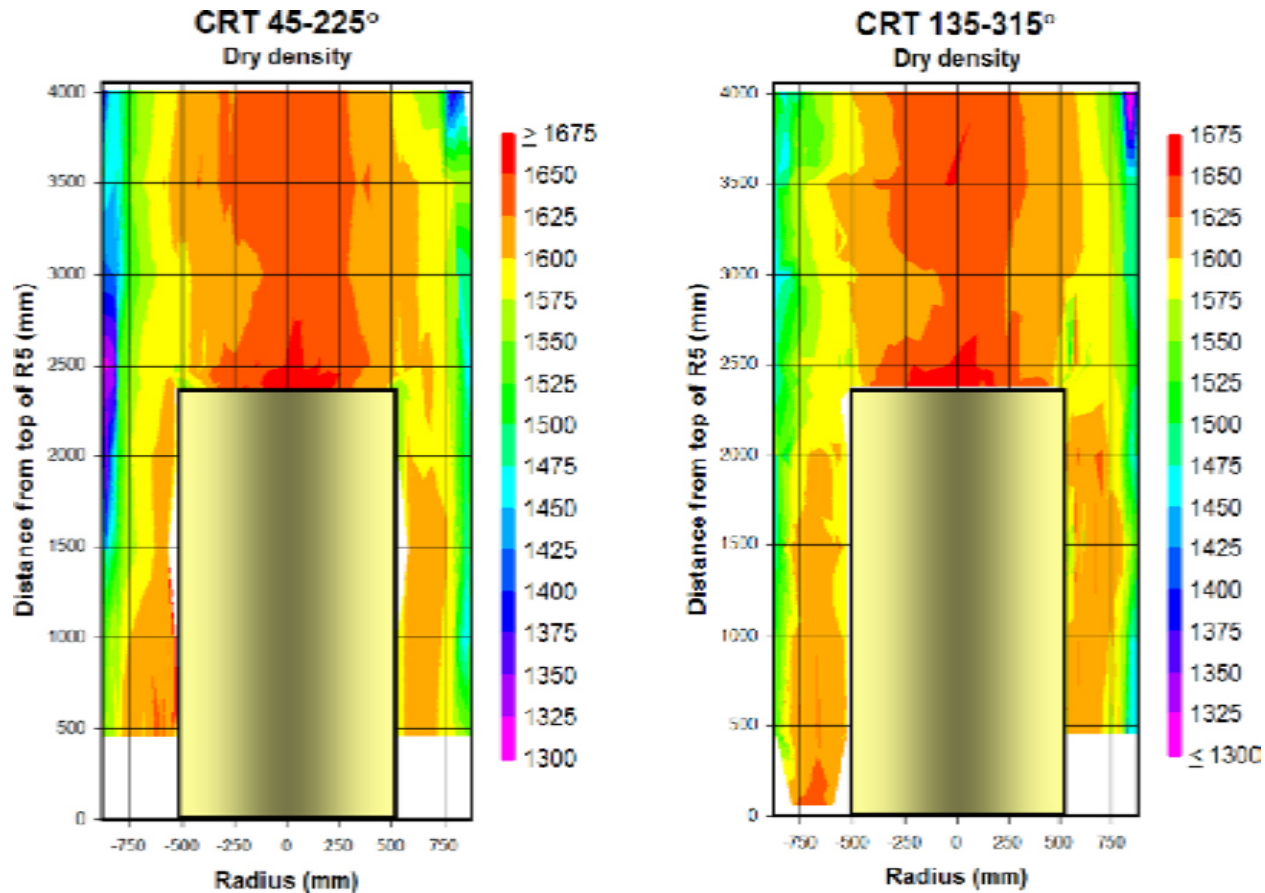

# HCB Consolidation and Shaping Demonstration

- Full-sized blocks produced
- Large-scale blocks can be pressed using commercial suppliers and a large, cold isostatic press
- A uniform block was pressed under an isostatic pressure of 100 MPa; dimensional expectations were fully met
- The dry densities exceed the minimum required value of 1.7 g/cm<sup>3</sup>
- Ongoing work continues to build confidence in the process and product

# APM Bentonite-Based Sealing Materials

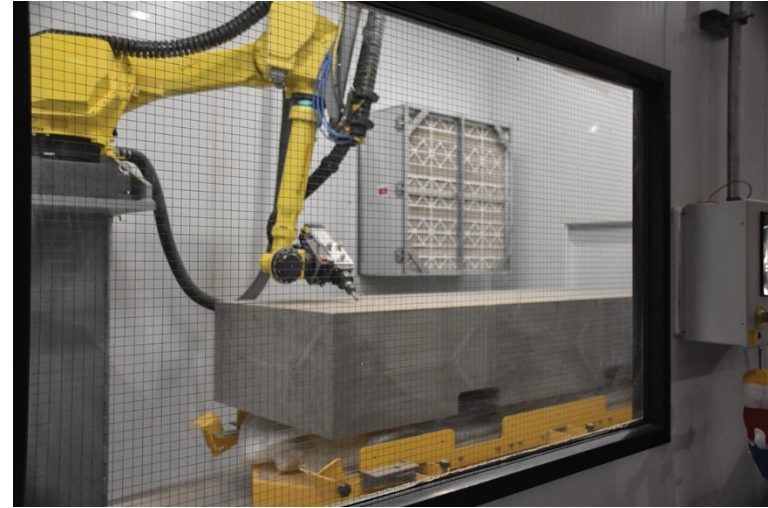

# Overview of Design and Proof-Testing Program

- Ongoing - activities have been planned and costed up to 2022
- Why 2022? To coincide with the estimated date for selection of a host community
- Program cost is \$150 million Canadian dollars
- In the absence of a site, our focus is on above ground activities
- All activities and operations will be proof tested
- Once a site is selected, additional to-be-defined work will be implemented in the Underground Demonstration Facility and above ground. This will likely include:
  - Assorted tests to provide additional confidence in barrier performance
  - Geoscientific verification tests



# Mechanical Integrity - External Pressure Test

## Full-Scale prototype test at Penn State (USA)

- Design pressure is 45 MPa (accounts for hydrostatic pressure, bentonite swelling pressure and glacial load)
- No damage at 45 MPa
- Buckling started at 57 MPa, as predicted

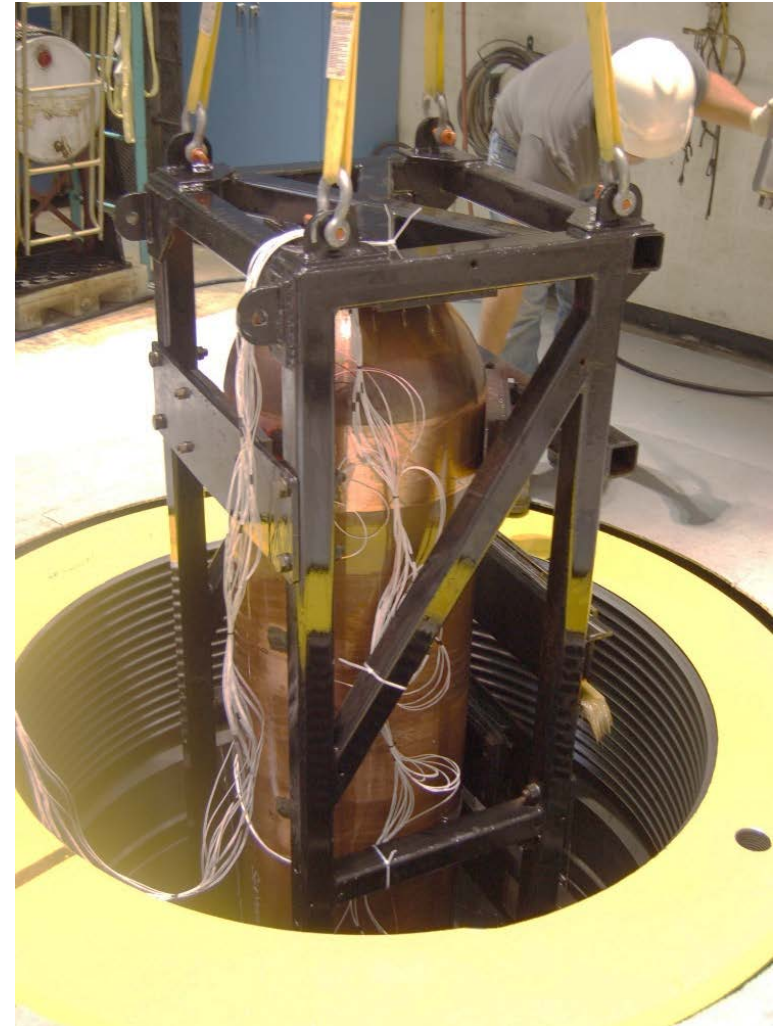

# Mechanical Integrity - Crush Testing

## Structural Vessel Shell

- Crushed until opposite edges touch to examine copper/weld integrity
- Copper coating did not delaminate
- No damage to weld



# Summary

Safety means protecting the public, the workers, and the environment from hazards associated with the repository

- The Safety Case is an integrated collection of arguments and evidence
- Safety Assessment estimates the ability to isolate and contain radioactivity

NWMO has an extensive design, optimization and proof-testing program underway:

- Addresses engineered barriers and placement technology
- Addresses above and below ground design concept
- Activities beyond 2022 will be further defined based on current work

Design includes full-scale room excavation trials underground in the Underground Demonstration Facility:

- Prove excavation methods and rock stability