



The Nature of Radiation



Neale Hunt
Manager – Used Fuel Safety Assessment
NWMO

nwmo

NUCLEAR WASTE
MANAGEMENT
ORGANIZATION

SOCIÉTÉ DE GESTION
DES DÉCHETS
NUCLÉAIRES

Outline of Talk



Topics

Radiation Basics

Nuclear Fuel

Human Exposure

Discussion and Questions

Length: About 30 minutes, depending on questions

Radiation Basics



Radiation is energy that comes from a source and travels through some material or space

The type of radiation discussed here is called **ionizing radiation** because it can produce electrically charged particles (**ions**) in matter

Non-Ionizing

Ionizing

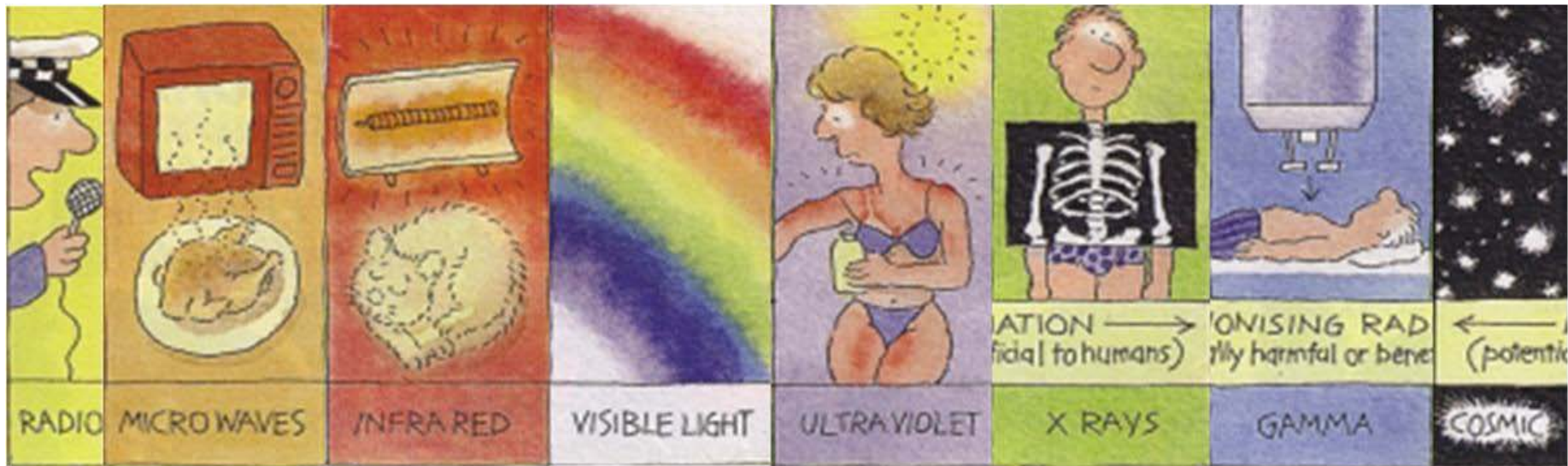

← Low energy

Electromagnetic Spectrum

High energy →

Radiation Basics

Ionizing Radiation is produced by unstable atoms

Unstable atoms differ from stable atoms in that they have excess mass

To reach stability, the nucleus of an unstable atom emits excess mass and energy

Unstable atoms are said to be **radioactive**

The emissions are called **radiation**

This process is called **radioactive decay**

An **ion** is an atom that has a net electric charge due to the loss or gain of an electron

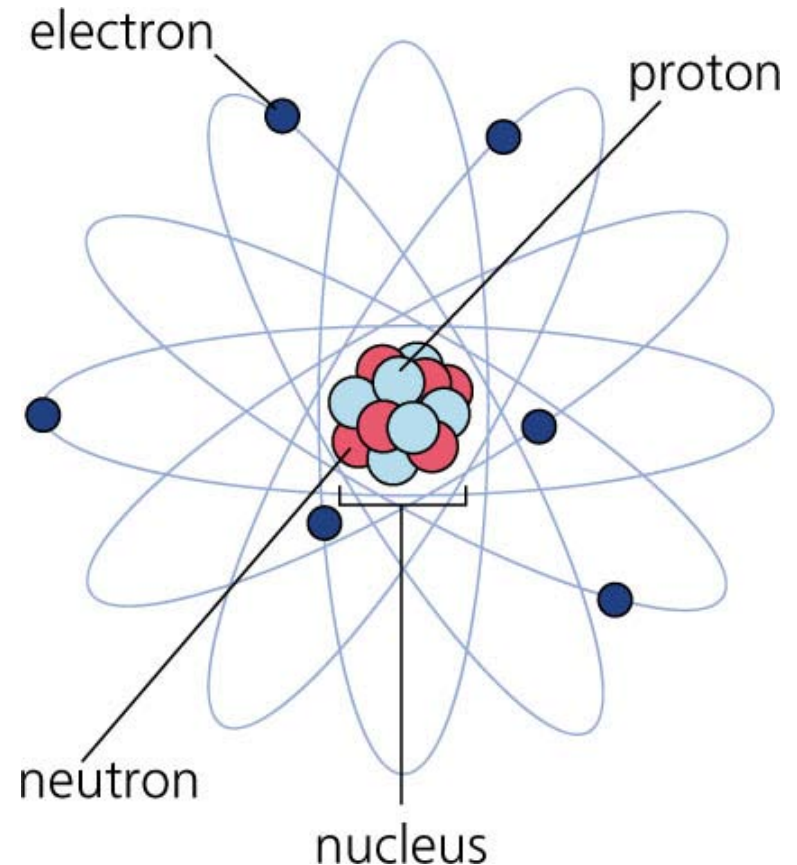

Radiation Basics



Excess energy is emitted as electromagnetic radiation (photons) called **Gamma Rays**

Excess mass is emitted as particles, usually **Alpha Particles** or **Beta Particles** but also **Neutrons** and other particles

An alpha particle is composed of 2 neutrons and 2 protons

A beta particle is an electron

When alpha and beta particles are emitted, the residue (i.e., the daughter) is a different atom

If the daughter is unstable, the decay process continues

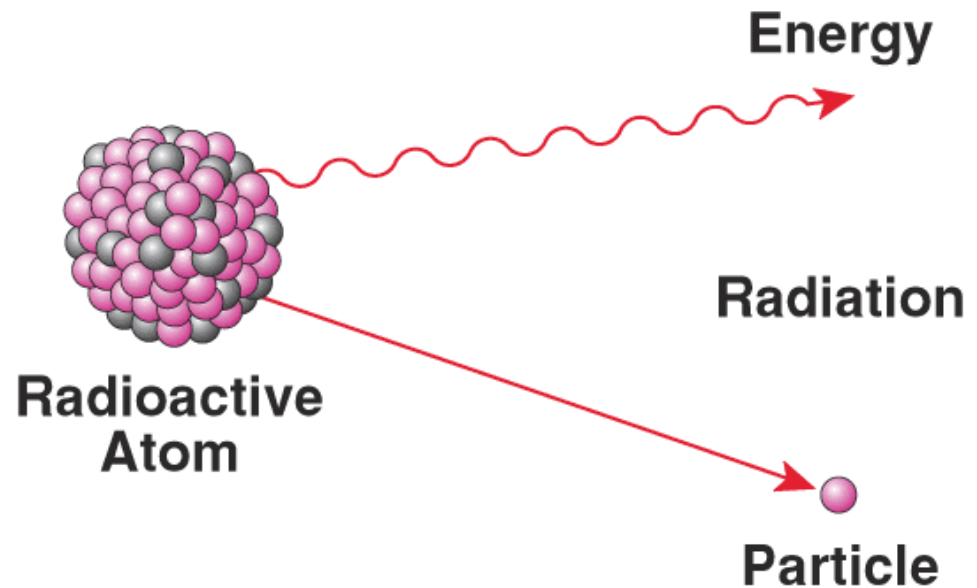

Radiation Basics



A **decay chain** is a series of radioactive decays

The rate of radioactive decay is measured in **becquerels (Bq)**, where 1 Bq is 1 decay per second

1 Bq is very small

70 kg human ~8000 Bq mostly due to C-14 (cosmogenic) and K-40 (primordial)

Notation:

- The 'C' in C-14 is the element (Carbon)
- The '14' in C-14 is the total of the number of neutrons and protons.
- Carbon has 6 protons, so C-14 has 8 neutrons

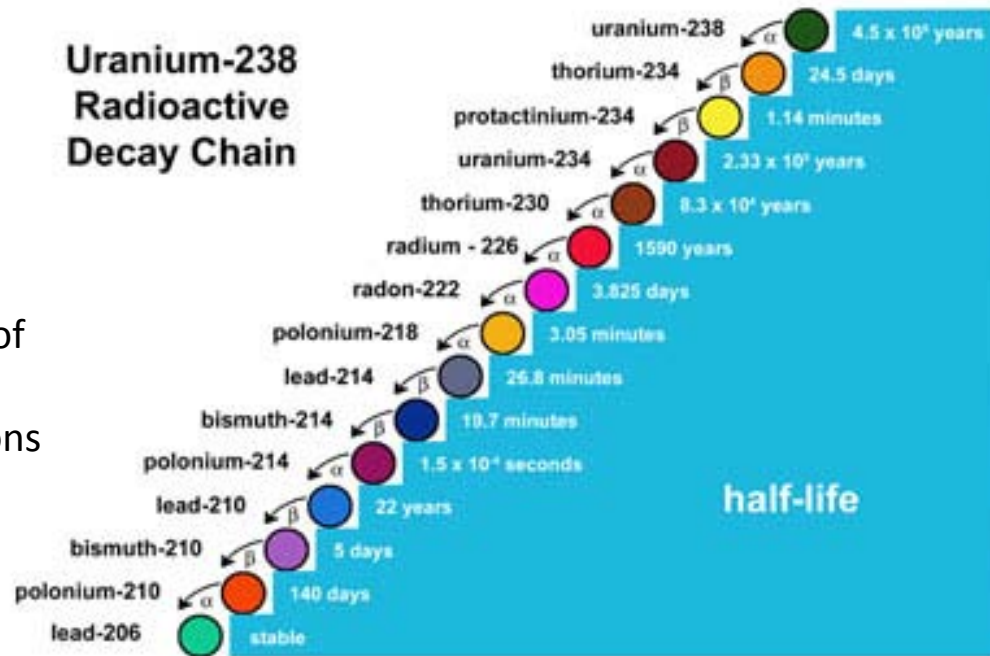

Radiation Basics



Radioactive Half Life ($t_{1/2}$)

Time taken for one-half of the original quantity of an unstable element to decay into something else

Half lives range from a fraction of a second to billions of years

- K-40: 1.25 billion years
- C-14: 5730 years

Half Lives	Remaining	Remaining
0	1	1
1	$(1/2)$	0.5
3	$(1/2)(1/2)(1/2) = (1/2)^3 = 1/8$	0.125
5	$(1/2)^5 = 1/32$	0.031
10	$(1/2)^{10} = 1/1024$	0.00098

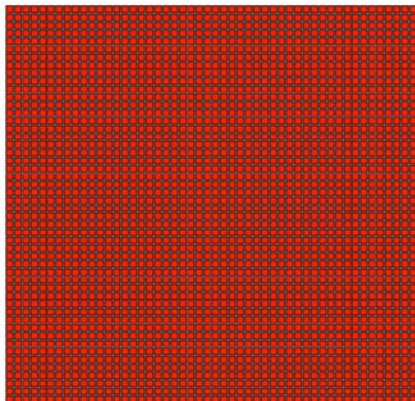

Initial

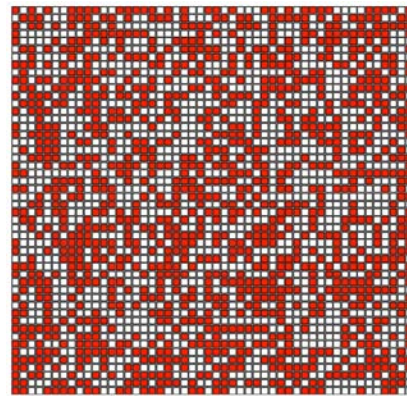

One half-life

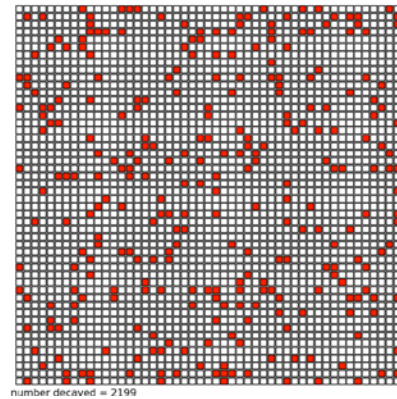

Three half-lives

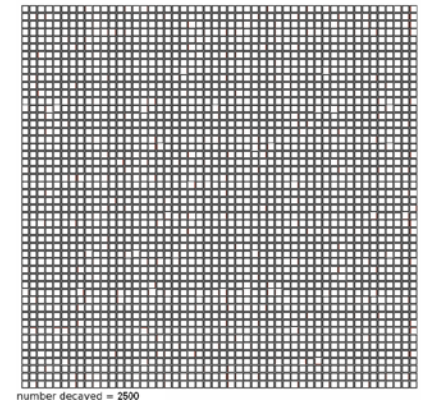

Eventually

Radiation Basics

Because gamma rays, neutrons, alpha particles and electrons all have different mass and different electrical charge, they interact with matter in different ways

This is important when:

- determining shielding requirements
- assessing the health risk associated with exposure of living tissue

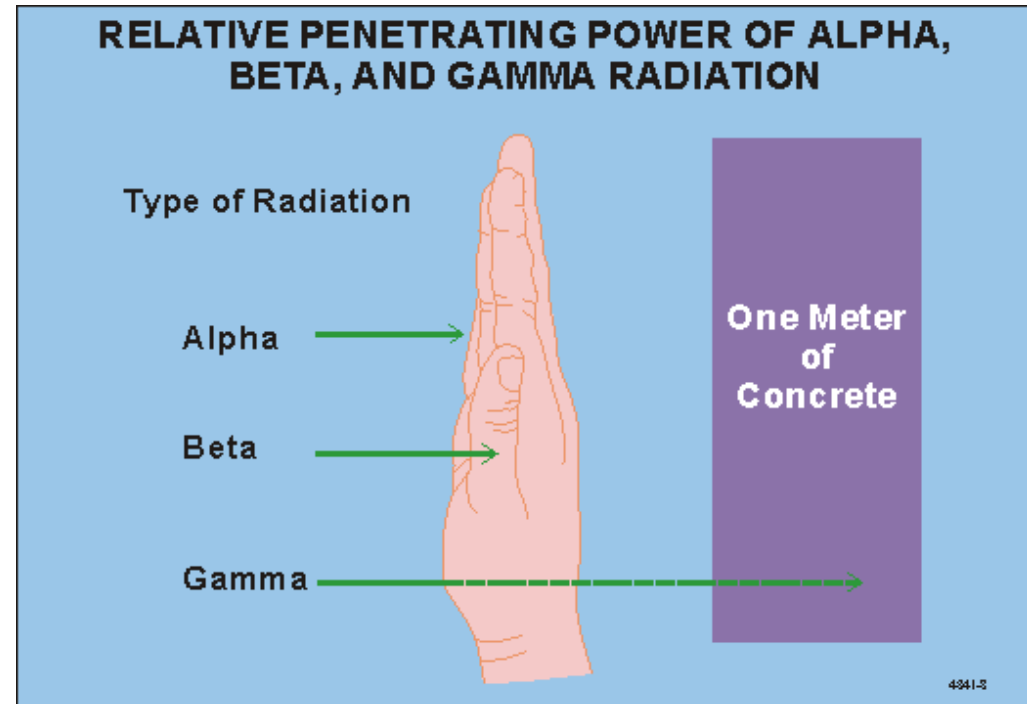

Radiation Basics - Detection

Ionizing radiation is invisible to human senses

Detection equipment is therefore needed

Almost all radiation detectors detect charged particles created as a result of the interaction of radiation with matter

The charged particles are accelerated by an electric field produced by a supplied external voltage



Some examples:

Geiger Counters

Ion Chambers

Solid State Detectors

Scintillation Counters

Continuous Air Monitors

Nuclear Fuel - Fresh

Material

UO₂

Solid

Looks the same before and after
19.3 kg U per bundle

Initial U Composition

U-238: 99.3%

U-235: 0.7 %

U-234: trace

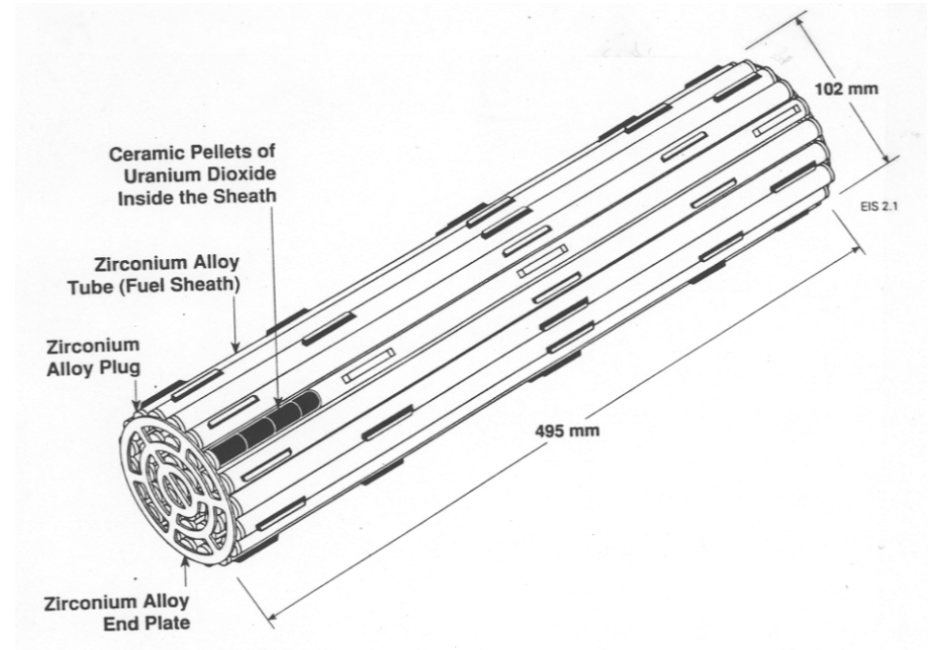

(U-238= 92 protons + 146 neutrons)

(U-235 = 92 protons + 143 neutrons)

Nuclear Fuel – Why is Used Fuel Radioactive?

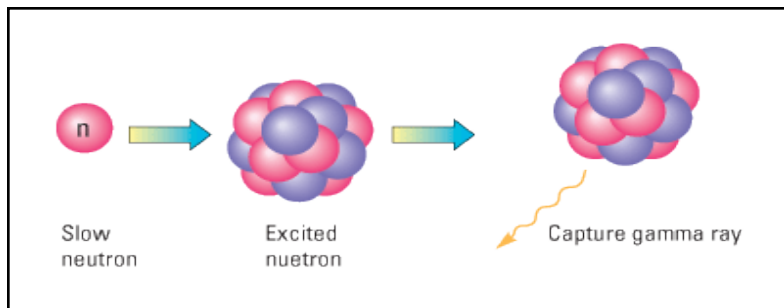
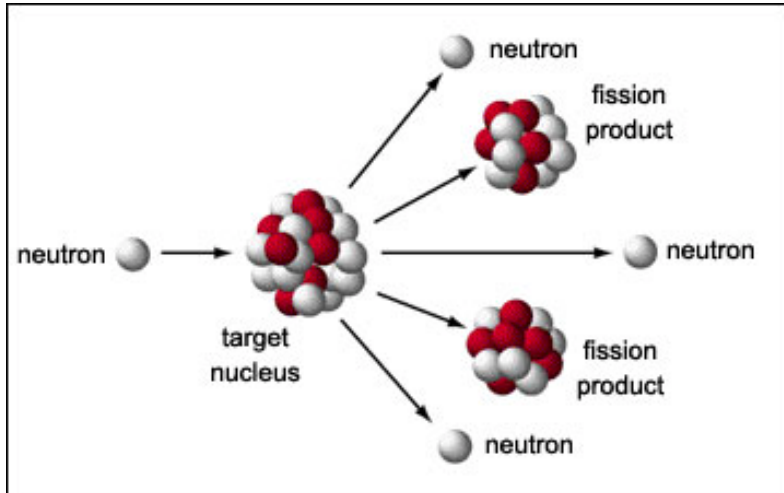

Fission

- U-235 is fissile (also Pu-235, Pu-241)
- Fissile material can undergo fission
- Fission results in the nucleus splitting into two or more parts (**called fission products**), together with the production of more neutrons
- Fission products can be highly radioactive, but are most are short-lived

Neutron Capture

- Atomic nuclei can capture neutrons, thereby affecting the neutron proton ratio
- These capture products can also capture neutrons

Used fuel has > 1000 nuclides when it is removed from the reactor

Nuclear Fuel - Radioactivity Change with Time

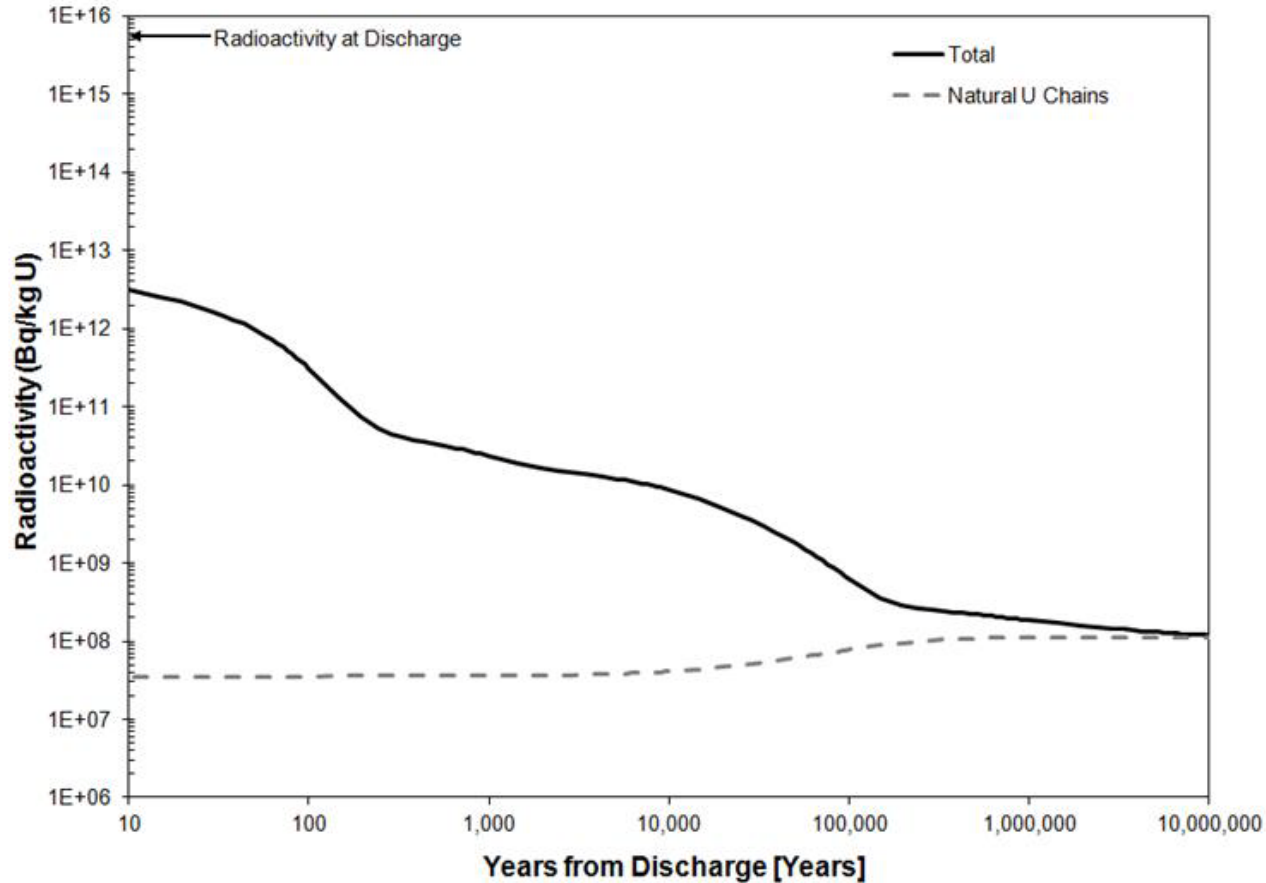

Radioactivity of Used CANDU Fuel with a Burnup of 220 MWh/kgU

Human Exposure

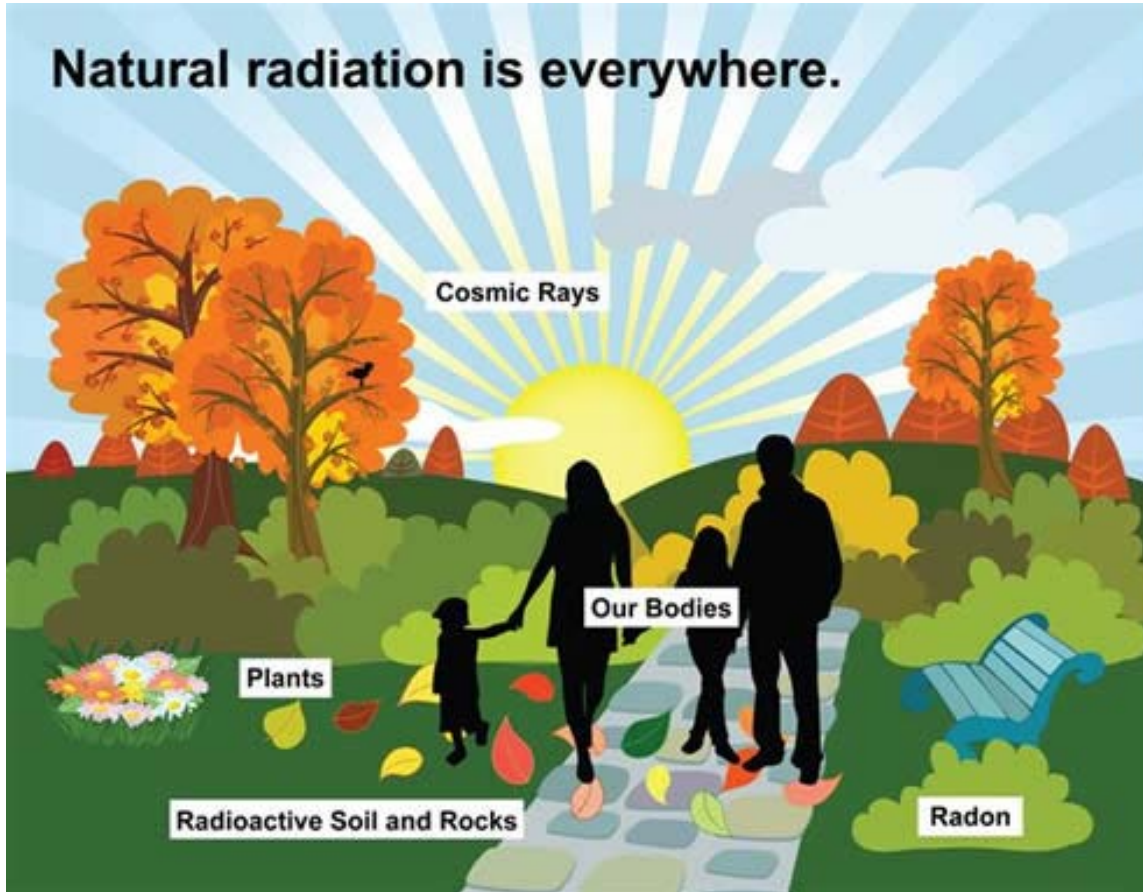
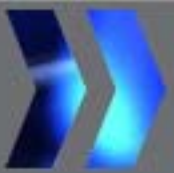

Radiation comes from:

- Air we breathe
- Food we eat
- Water we drink
- Buildings we live in
- Products we use
- Sky and the earth

Exposure Pathways:

- External
- Ingestion
- Inhalation

Human Exposure – What is a Dose?

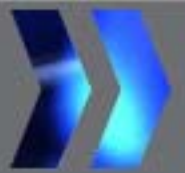

When radiation penetrates an object, it interacts with the atoms in that object and deposits energy

The energy deposited is called the **absorbed dose**, measured in **Grays** (J/kg)

Ionizing radiation is of concern because it has enough energy to break chemical bonds in tissue

The effect of ionizing radiation on tissue depends on:

- The type of radiation received (e.g., a 1 Gy internal alpha exposure is more damaging than a 1 Gy internal beta exposure),
- The organ that receives the radiation (e.g., exposure of the skin has less consequence than exposure of the lungs), and
- The duration of the exposure.

Doses are usually quoted as **effective whole body doses**, which take the above factors into account

The unit of effective whole body dose is the **Sievert** (Sv), but because 1 Sv is a very large dose, doses are usually expressed in **milliSievert** (mSv or 1/1000 Sv)

Human Exposure – Linear No Threshold Model

The LNT Model is used to quantify the risks of radiation exposure and to set regulatory limits

At high doses, the risk shows a linear dependence on dose, but at low values, the effect is so small that it is difficult to measure.

To generate risk information for low doses, **it is assumed** that the behaviour seen at high doses can be linearly extrapolated into the low dose regime

There is a body of evidence that supports other models; however, the LNT model is adopted in the interests of prudent and conservative decision making for radiation protection

Models for the Health Risks from Exposure to Low Levels of Ionizing Radiation

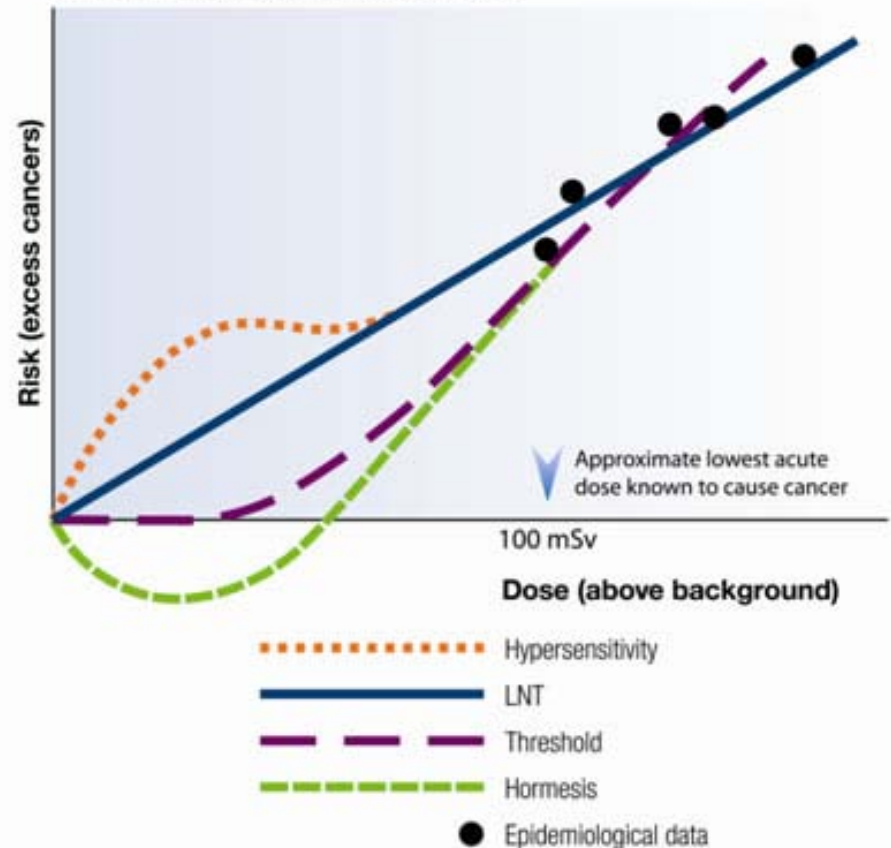

Human Exposure - Dose Limits and Typical Doses

Dose (mSv)	Consequence (from CNSC website)
5000	May lead to death if received all at once
1000	Temporary radiation sickness if received with 24 hours
150	Average annual dose to astronauts on the space station
100	Lowest acute dose known to cause cancer
30 – 100	Full body CAT scan
50	Regulatory Annual Limit for Nuclear Energy Workers
10	Typical pelvic CT scan
8	Average Annual Natural Background Dose in Finland
4	Regulatory Annual Limit for Pregnant Nuclear Energy Workers
1.8	Average Annual Natural Background Dose in Canada
1	Regulatory Annual Limit for Members of the Public
0.7	Typical abdominal x-ray
0.2	Typical mammogram
0.01	Average annual dose due to air travel
0.005	One dental X-ray
0.001	Typical annual dose from living within a few km of an operating NPP
<0.001	Anticipated Annual Dose from a DGR – if living on top of the repository

Questions and Discussion

